



US00D426279S

United States Patent [19]

Swanson et al.

[11] Patent Number: **Des. 426,279**

[45] Date of Patent: **** Jun. 6, 2000**

[54] **GUN BARREL FRONT END RETAINING HEAD FOR RAPID RELEASE MOUNT**

4,854,066 8/1989 Canterbury, Sr. D22/108 X

[76] Inventors: **Ronald J. Swanson; Jeffrey R. Swanson; David A. McMaster**, all of 5220 W. 104th St., Los Angeles, Calif. 90045

Primary Examiner—Louis S. Zarfes
Assistant Examiner—Monica A. Weingart
Attorney, Agent, or Firm—Allan M. Shapiro

[**] Term: **14 Years**

[57] **CLAIM**

The ornamental design for a gun barrel front end retaining head for rapid release mount, as shown and described.

[21] Appl. No.: **29/098,023**

DESCRIPTION

[22] Filed: **Dec. 21, 1998**

[51] **LOC (7) Cl.** **22-01**

[52] **U.S. Cl.** **D22/109; D22/100; D22/108; D22/199**

[58] **Field of Search** D22/100, 101, D22/108, 109, 199; 89/37.03, 37.04, 40.06

FIG. 1 is an isometric view from the front, top and right side of a gun barrel front end retaining head for rapid release mount, showing our new design;

FIG. 2 is an isometric view from the rear, top and right side thereof;

FIG. 3 is a front elevational view thereof;

FIG. 4 is a rear elevational view thereof;

FIG. 5 is a left side elevational view thereof;

FIG. 6 is a right side elevational view thereof;

FIG. 7 is a bottom plan view thereof;

FIG. 8 is a sectional view thereof taken in the direction of the arrows along line 8—8 in FIG. 3; and,

FIG. 9 is a sectional view thereof taken in the direction of the arrows along line 9—9 in FIG. 3.

[56] **References Cited**

U.S. PATENT DOCUMENTS

D. 297,450	8/1988	Florida	D22/108
D. 297,660	9/1988	Clatanoff	D22/108
D. 381,388	7/1997	Raia	D22/199 X
D. 391,616	3/1998	Plybon	D22/100 X
D. 395,070	6/1998	McGowan	D22/108
3,655,106	4/1972	Wojcinski	D22/108 X

1 Claim, 1 Drawing Sheet

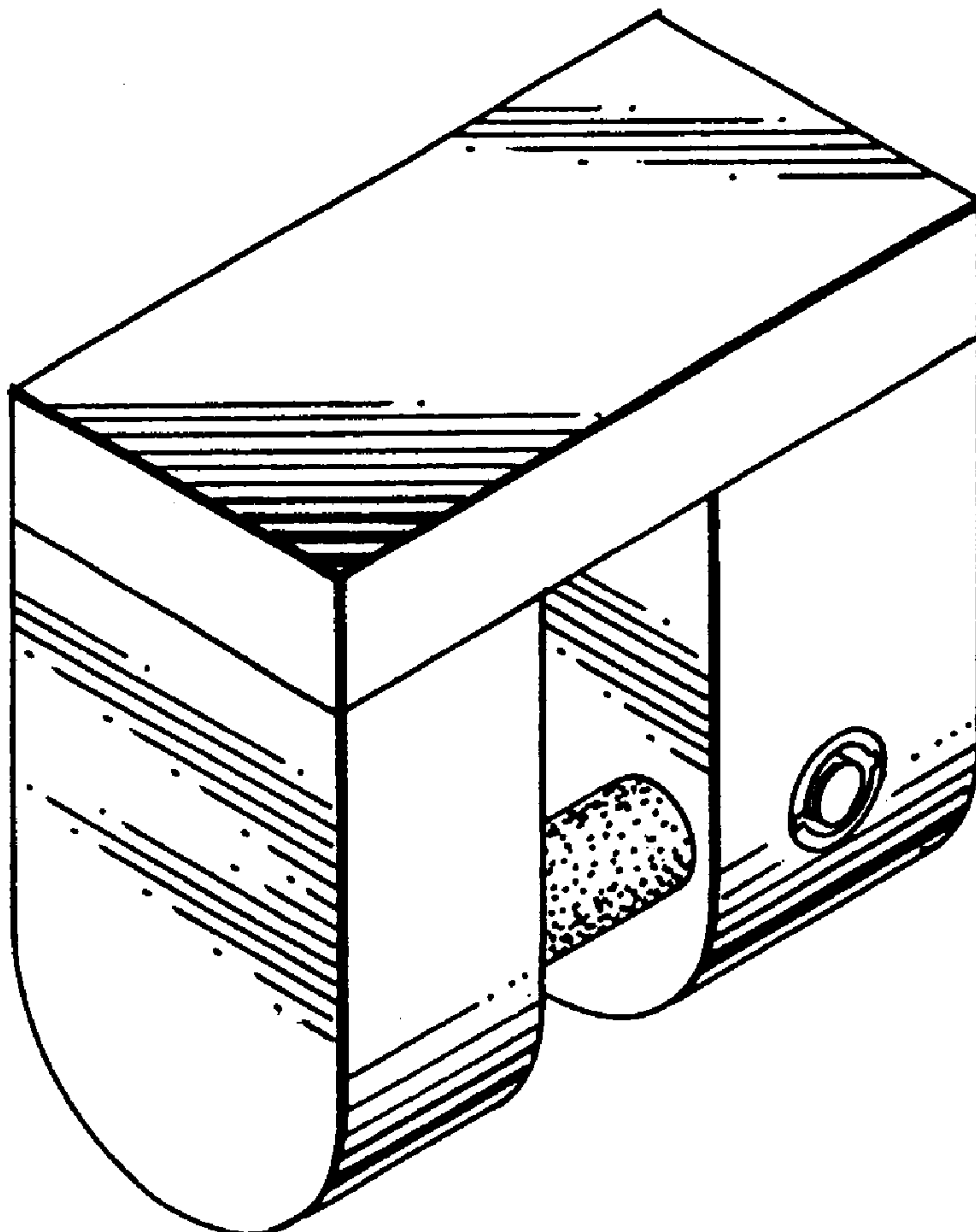

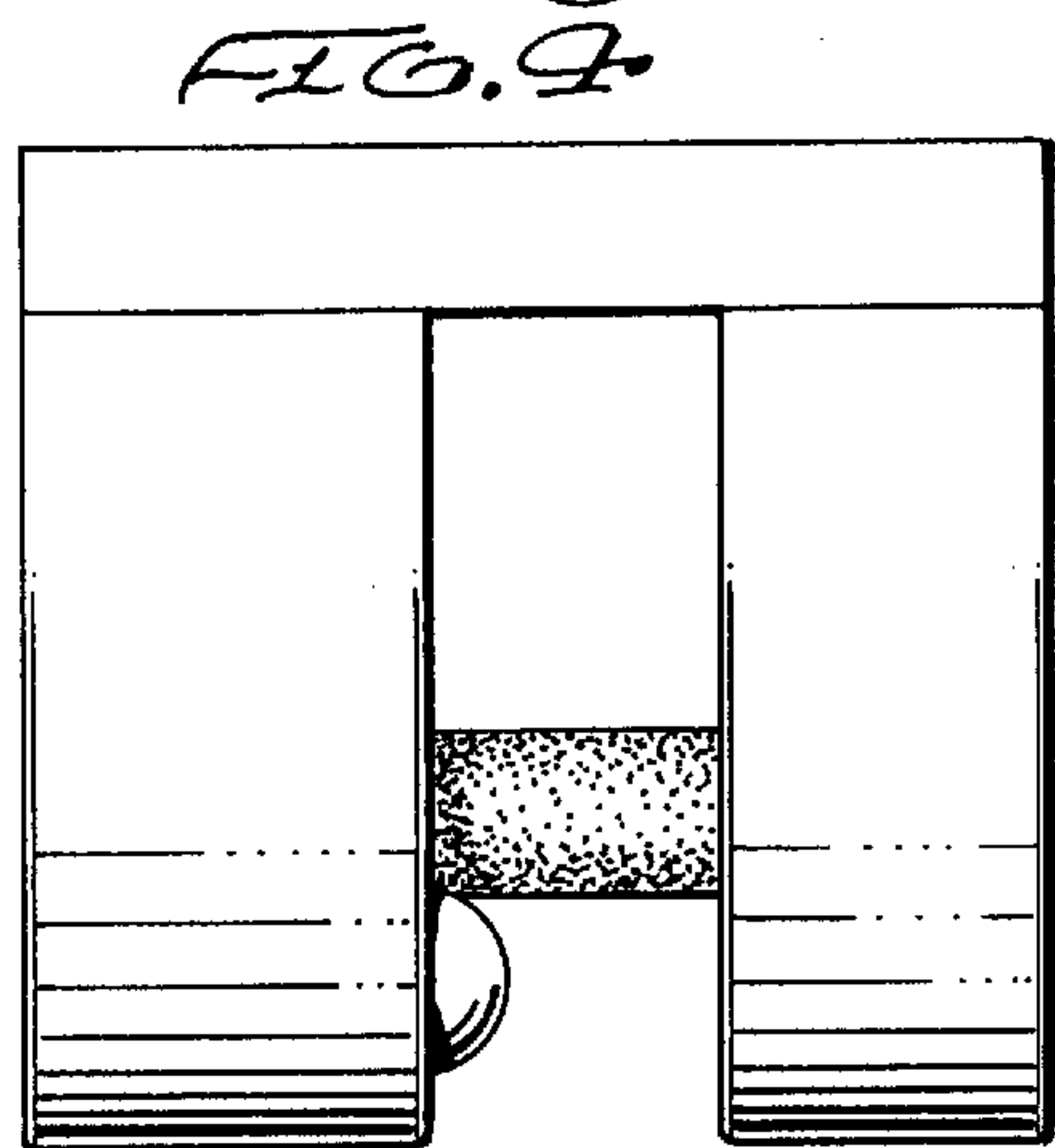
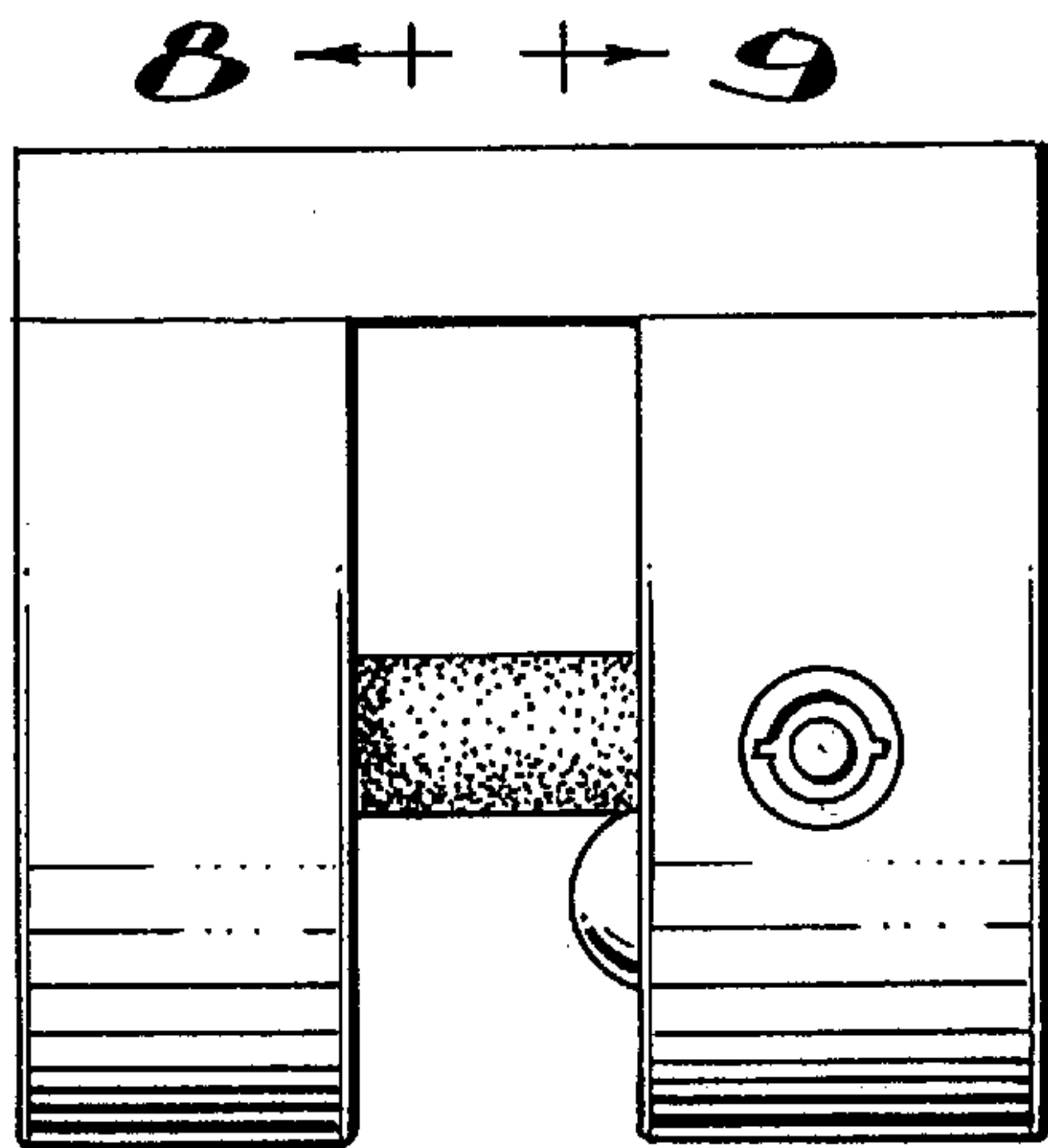
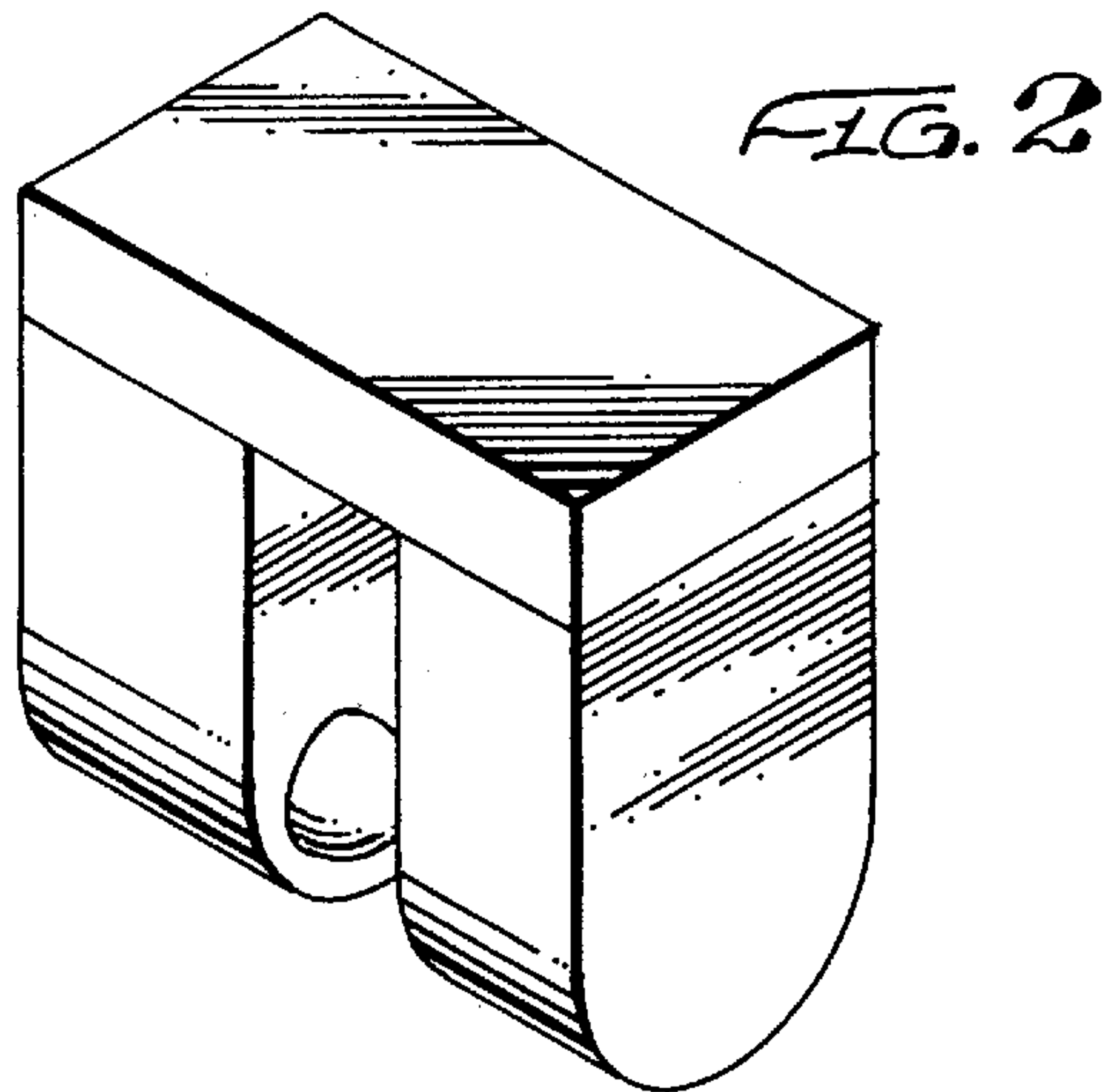
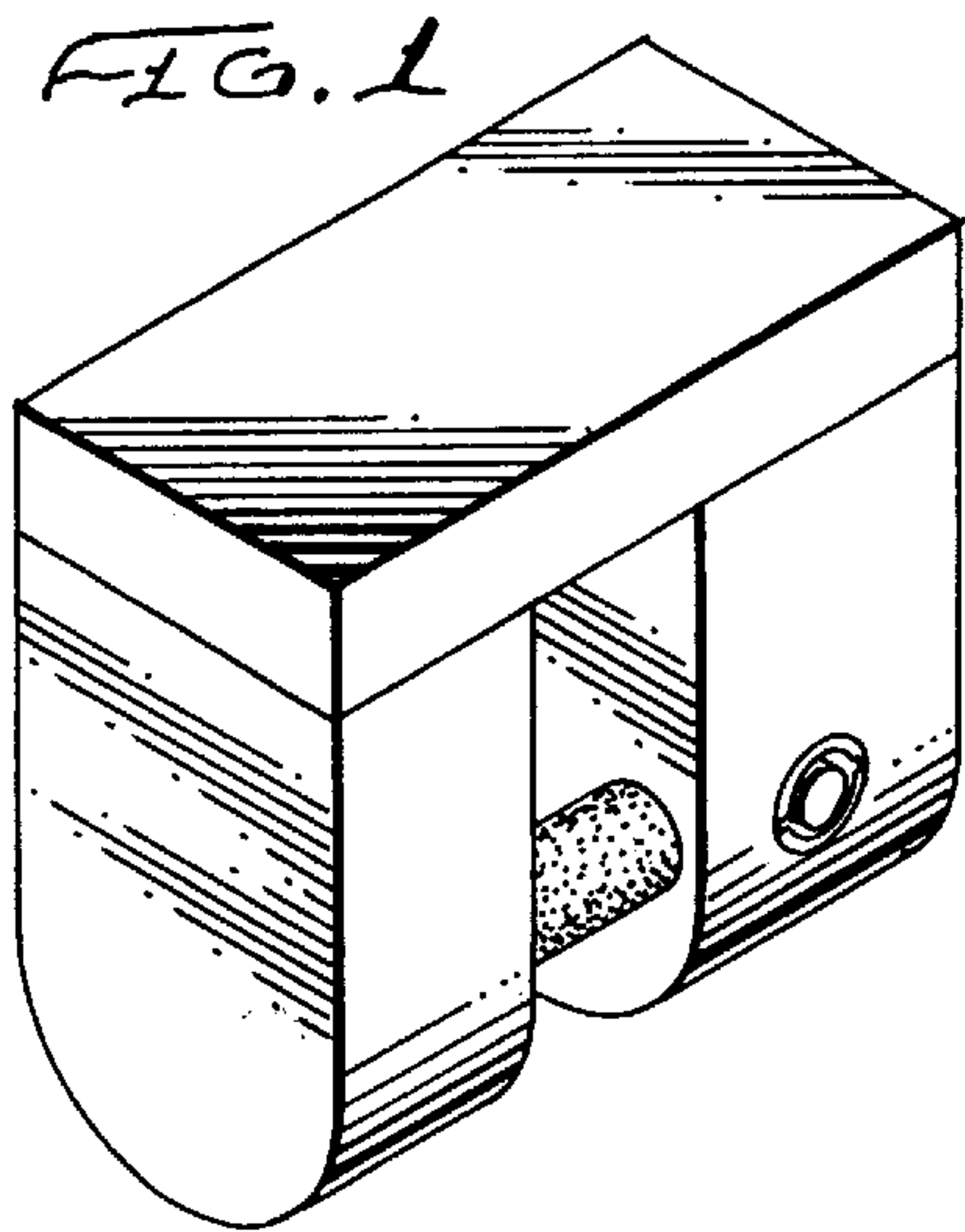

8 ← + + → 9

FIG. 8

FIG. 9

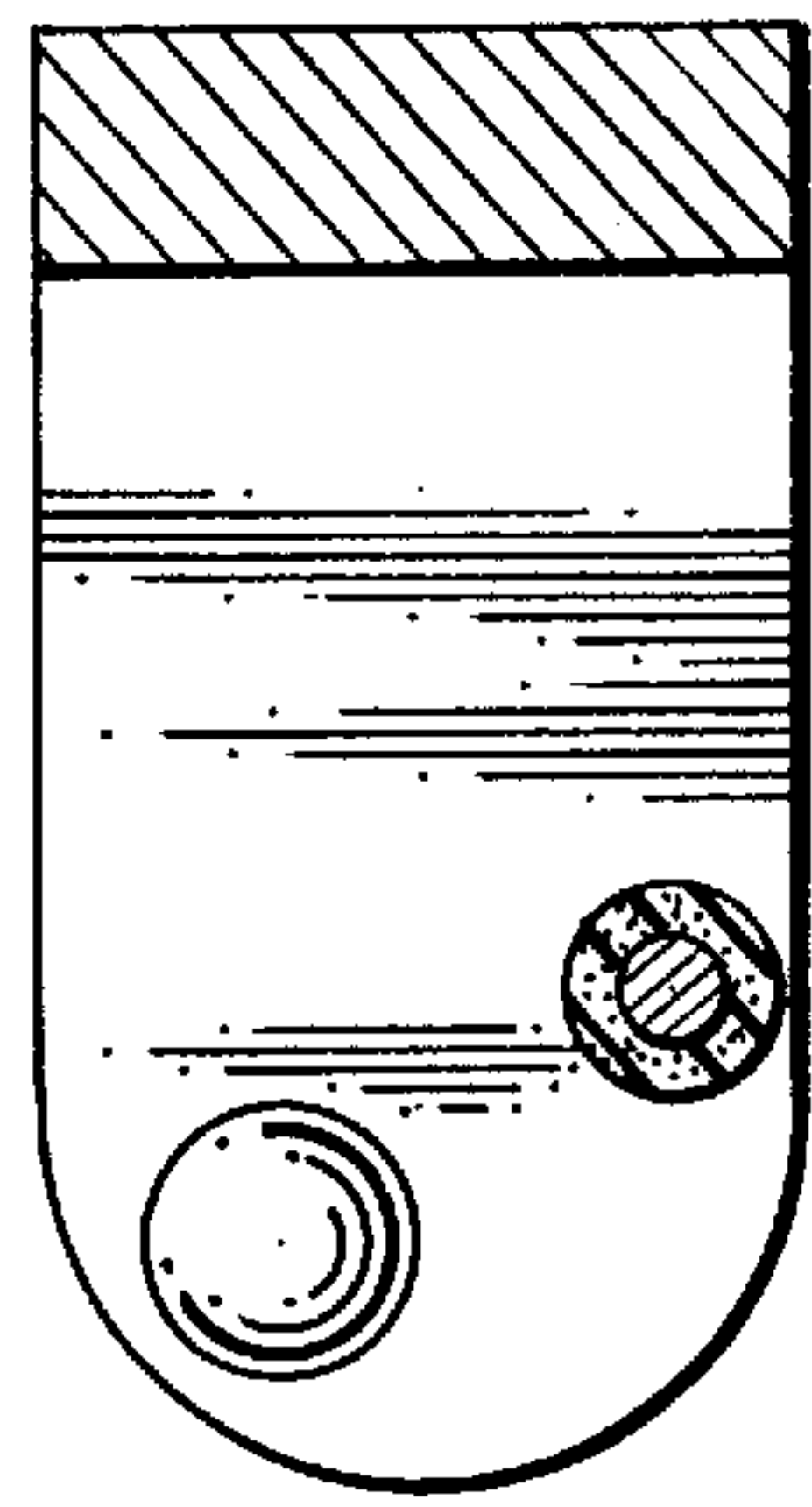
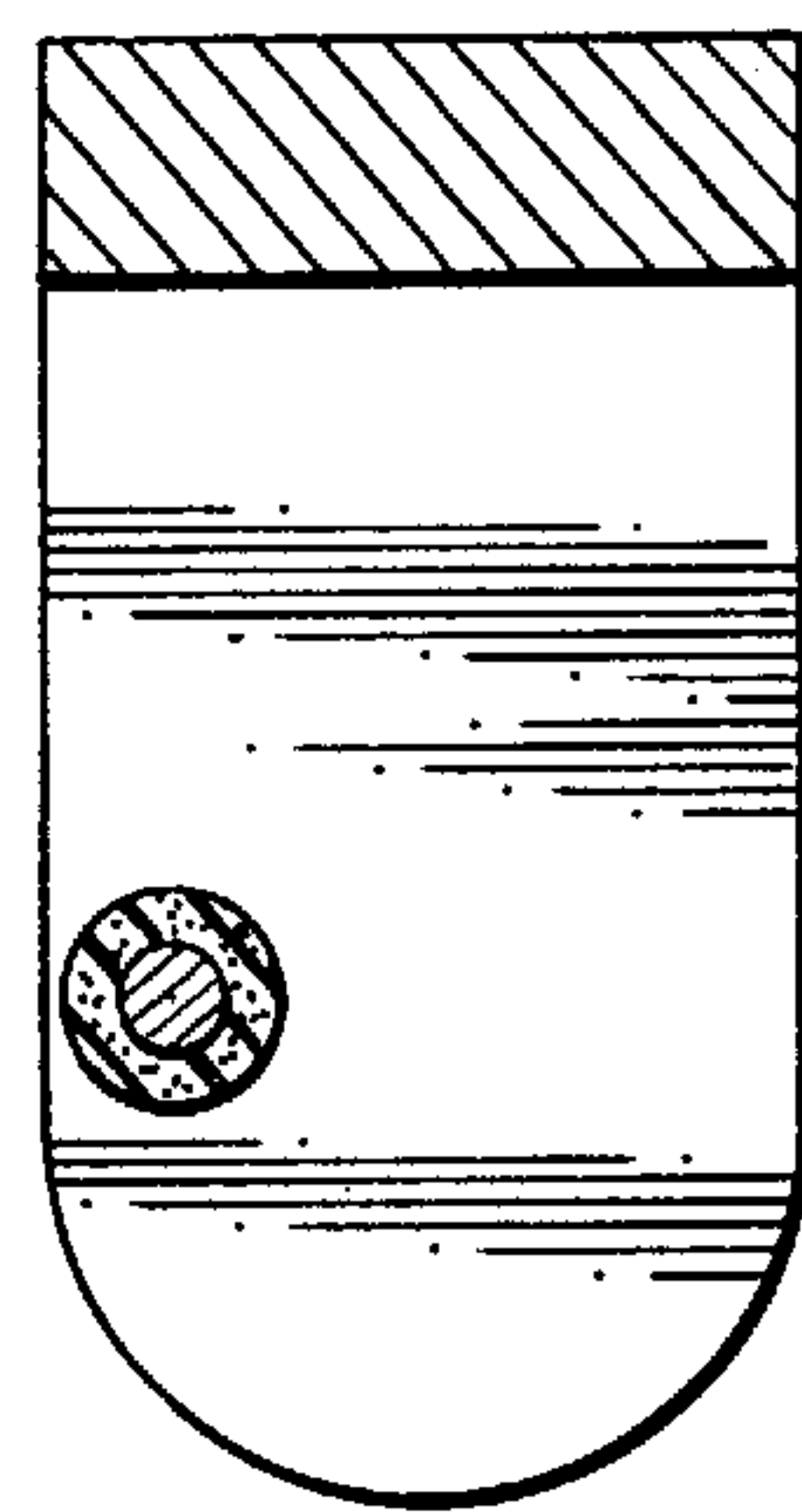

FIG. 3

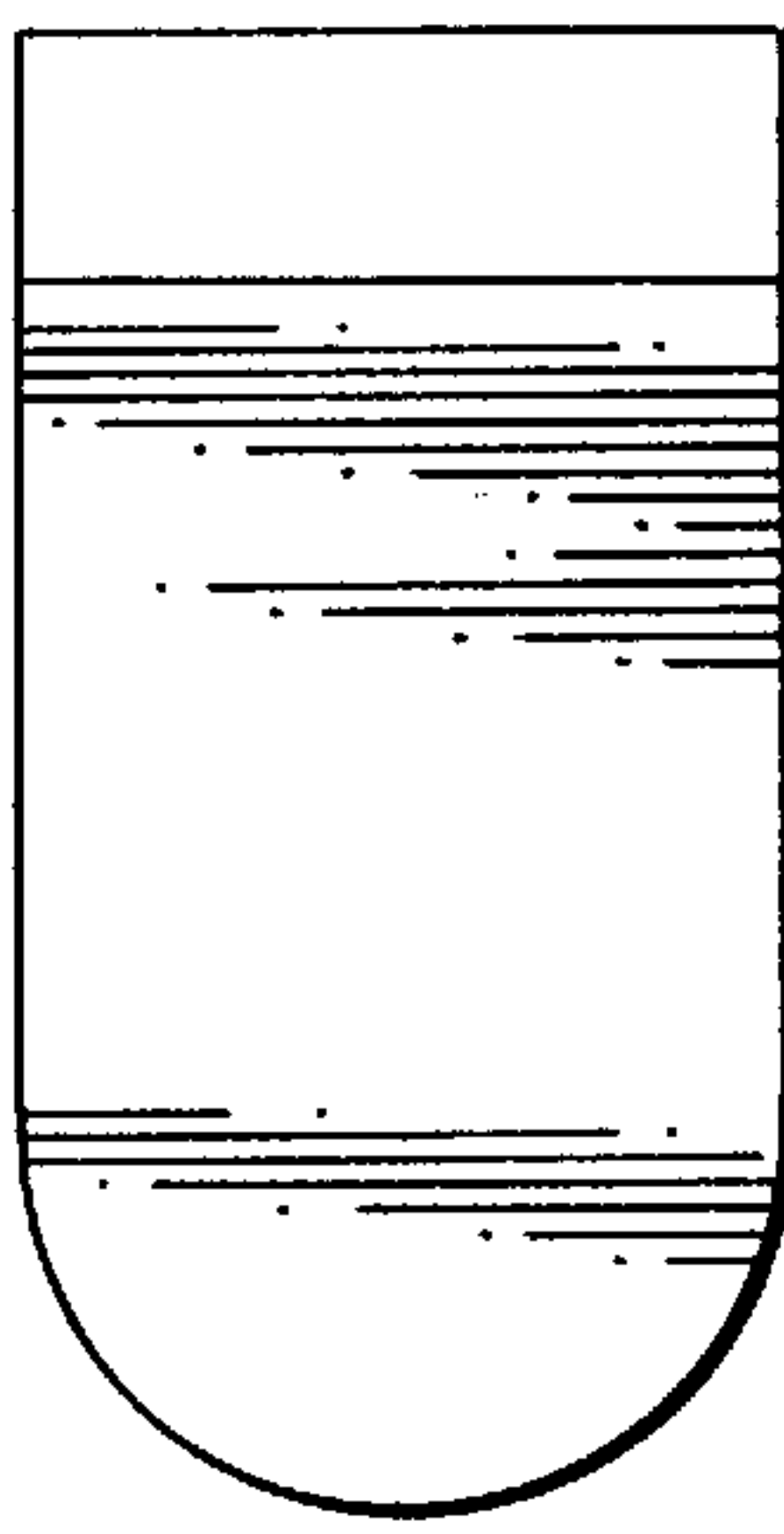
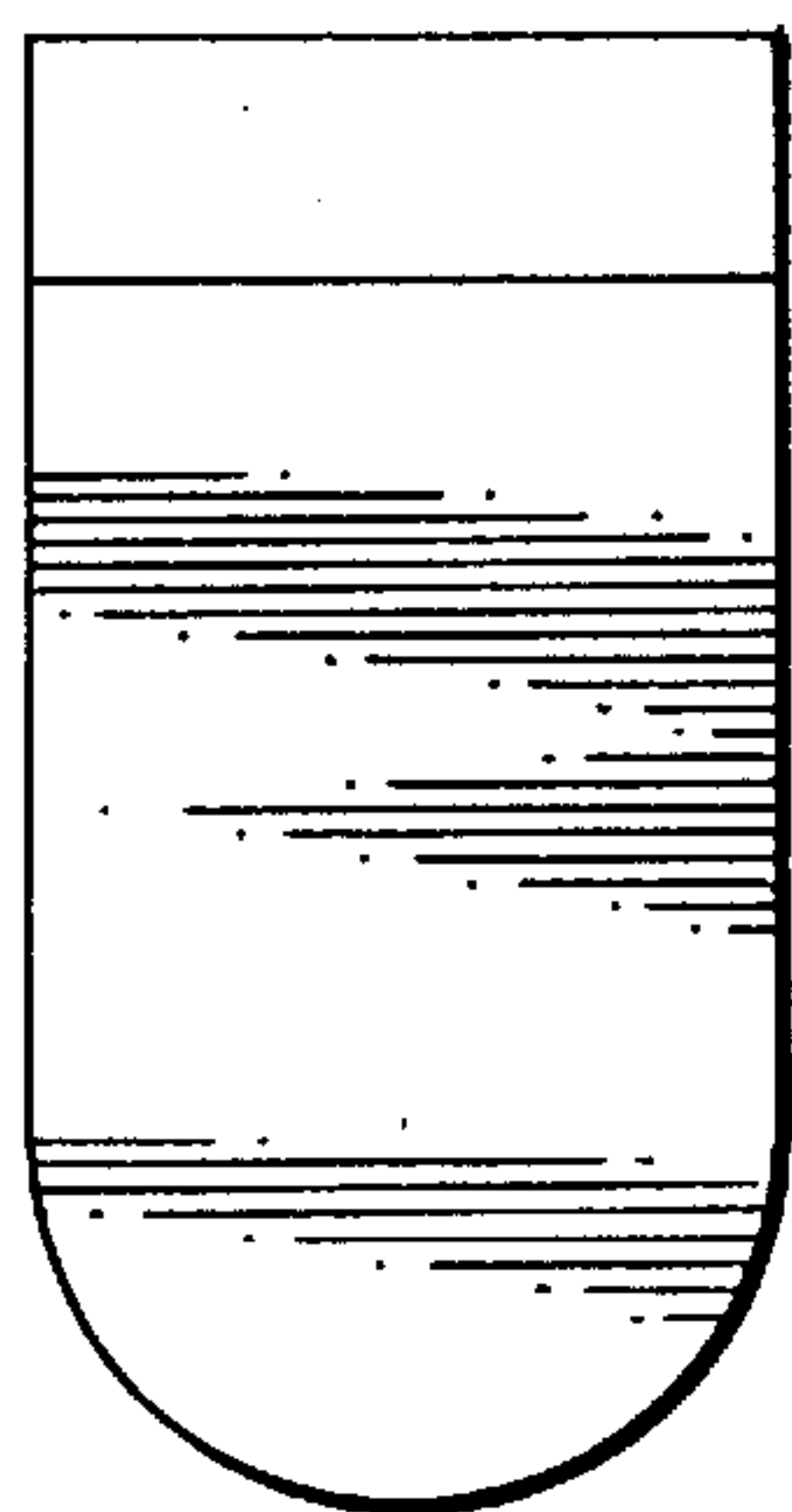

FIG. 7

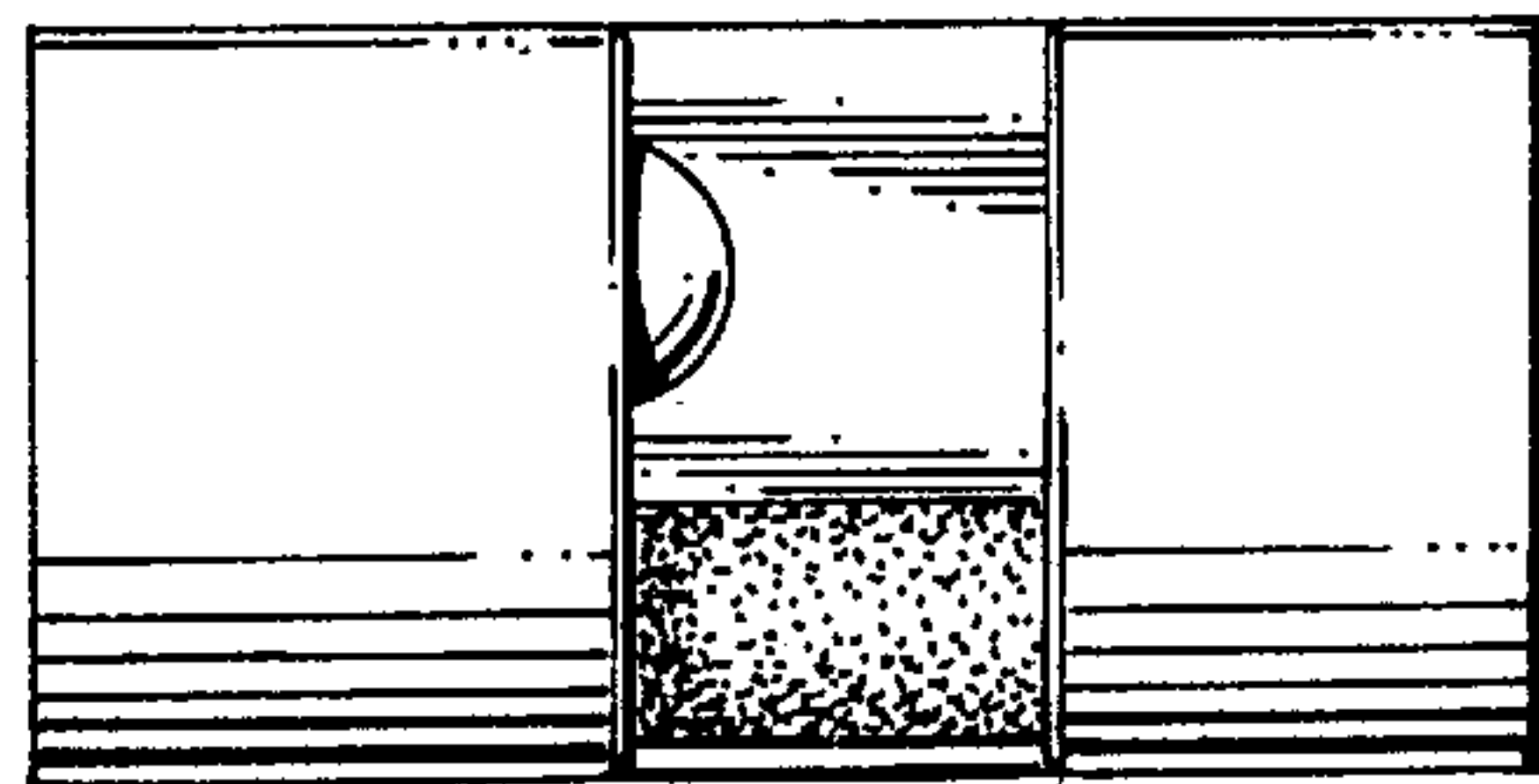

FIG. 5

FIG. 6