



US00D426226S

**United States Patent** [19]  
**Ridinger**

[11] **Patent Number: Des. 426,226**  
[45] **Date of Patent: \*\* Jun. 6, 2000**

[54] **ELECTRONIC TUNER FOR MUSICAL INSTRUMENTS**

D. 260,891 9/1981 Fink ..... D14/196  
D. 388,789 1/1998 Kokkinis ..... D14/194  
2,272,937 2/1942 Emde ..... D14/195 X

[76] Inventor: **Steve Ridinger**, P.O. Box 5030, San Clemente, Calif. 92674-5030

*Primary Examiner*—Nanda Bondade  
*Attorney, Agent, or Firm*—DeWitt Ross & Stevens S.C.

[\*\*] Term: **14 Years**

[57] **CLAIM**

[21] Appl. No.: **29/114,356**

The ornamented design for an electronic tuner for musical instruments, as shown and described.

[22] Filed: **Nov. 22, 1999**

**DESCRIPTION**

[51] **LOC (7) Cl.** ..... **14-03**

[52] **U.S. Cl.** ..... **D14/188**

[58] **Field of Search** ..... D14/168, 188,  
D14/189, 193-198; 455/344, 347, 350,  
351

FIG. 1 is a perspective view of an electronic tuner for musical instruments showing my new design; FIG. 2 is a front elevational view thereof; FIG. 3 is a right side elevational view thereof; FIG. 4 is a left side elevational view thereof; FIG. 5 is a top plan view thereof; and, FIG. 6 is a bottom plan view thereof.

[56] **References Cited**

The rear elevational view is unornamented and forms no part of the claimed design.

**U.S. PATENT DOCUMENTS**

D. 212,716 11/1968 Keenan ..... D14/194  
D. 216,650 2/1970 Tsukamoto ..... D14/194  
D. 252,425 7/1979 Hamada et al. .... D14/194

**1 Claim, 3 Drawing Sheets**

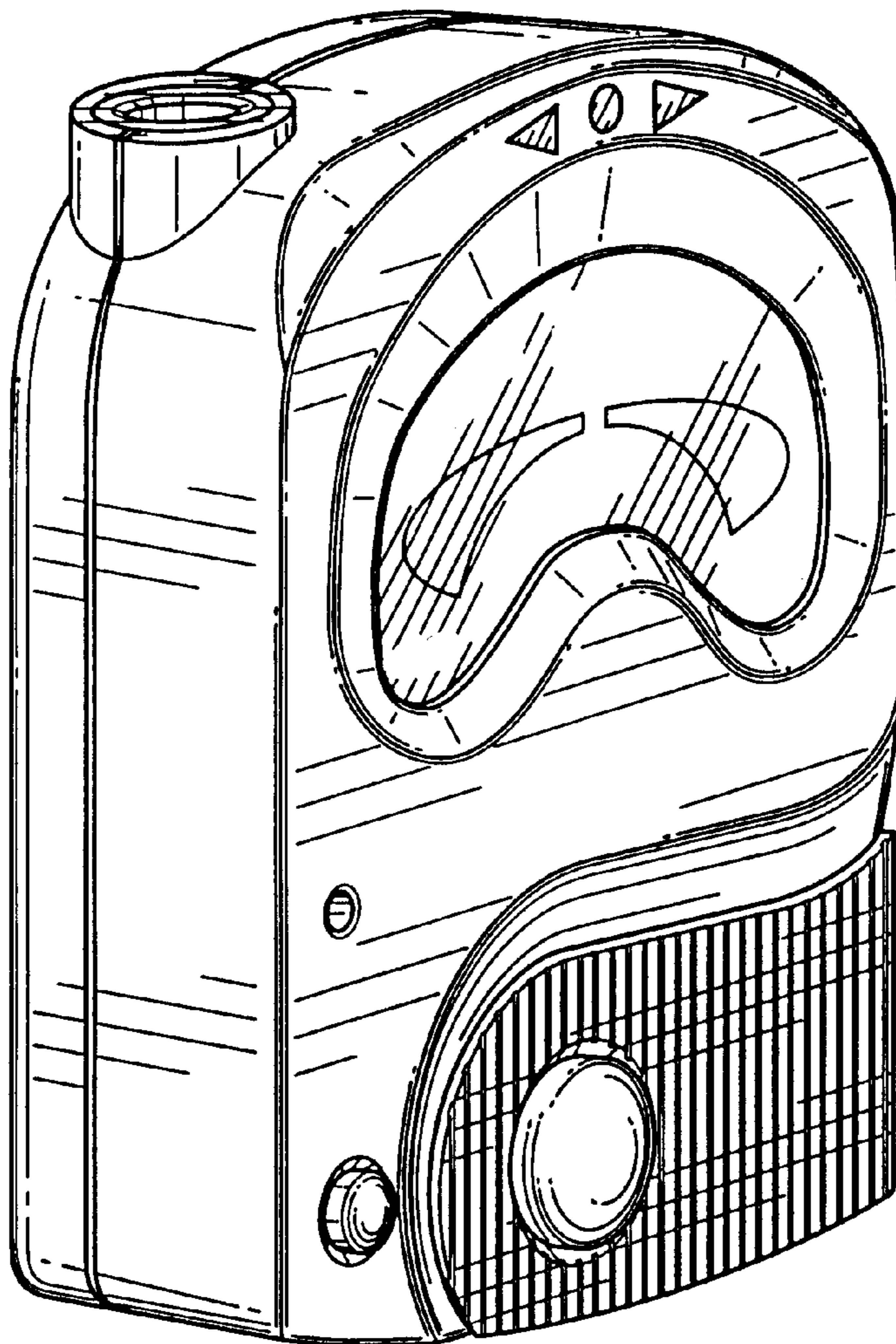

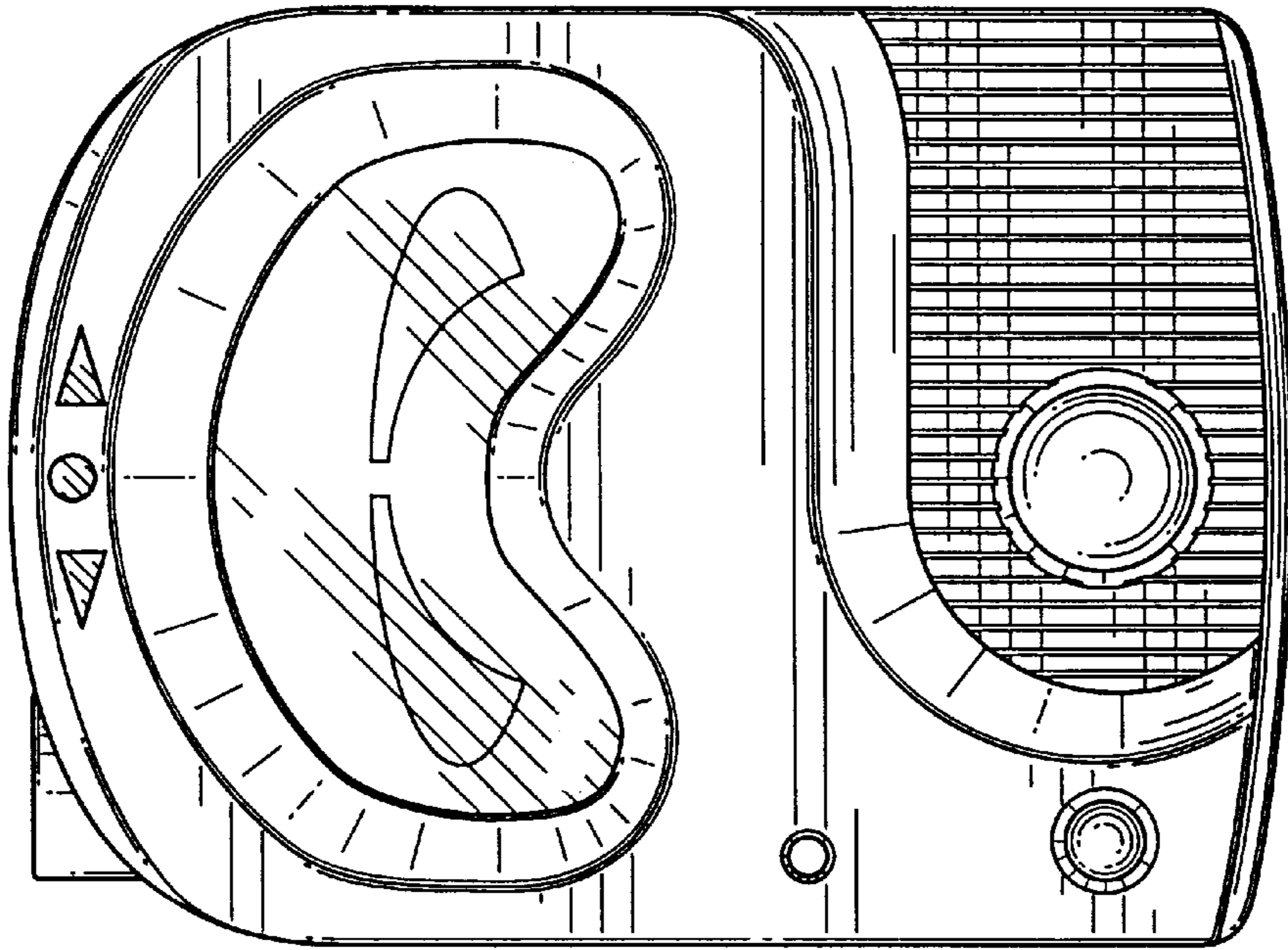

FIG. 2

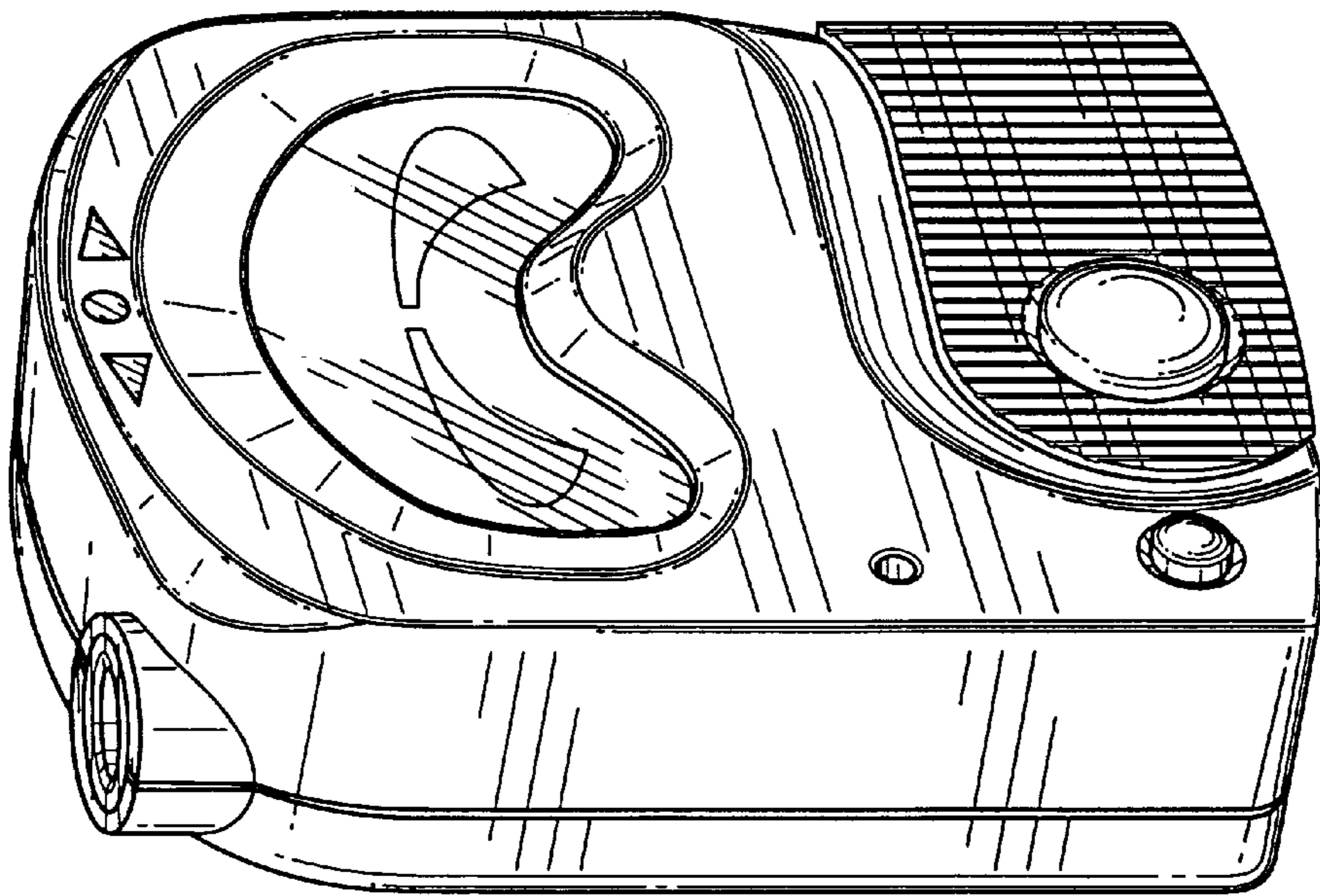

FIG. 1

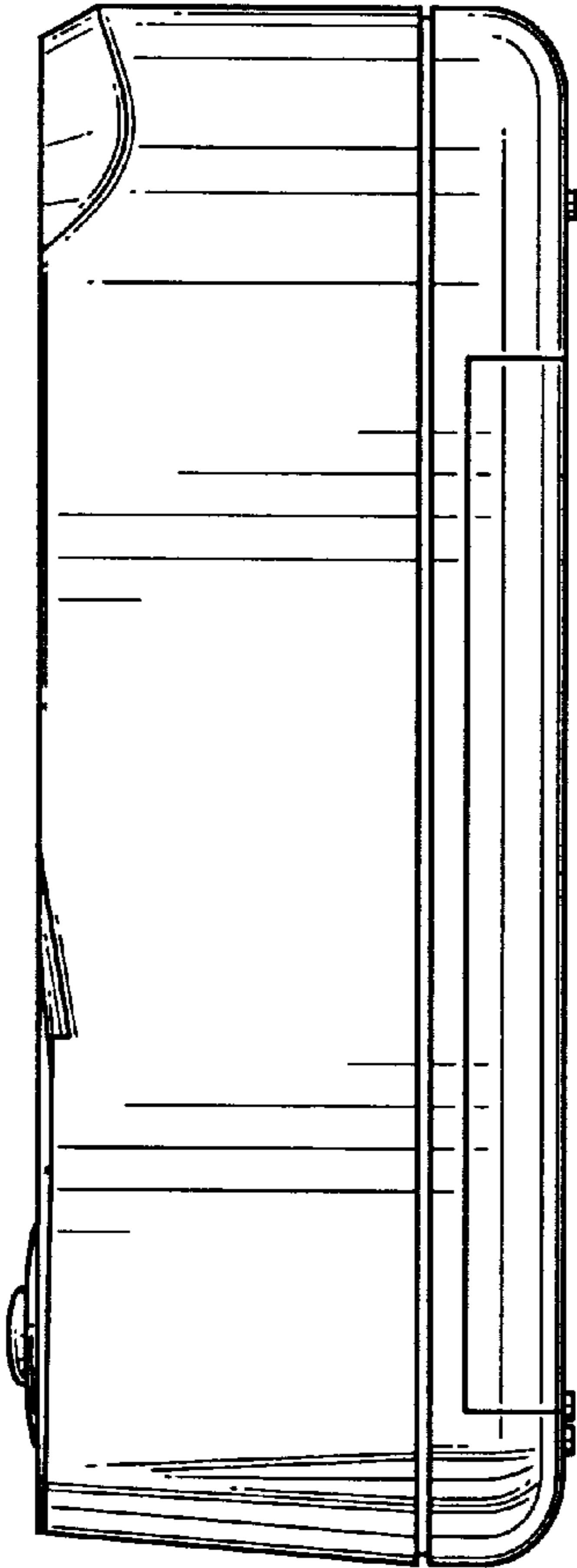

FIG. 3

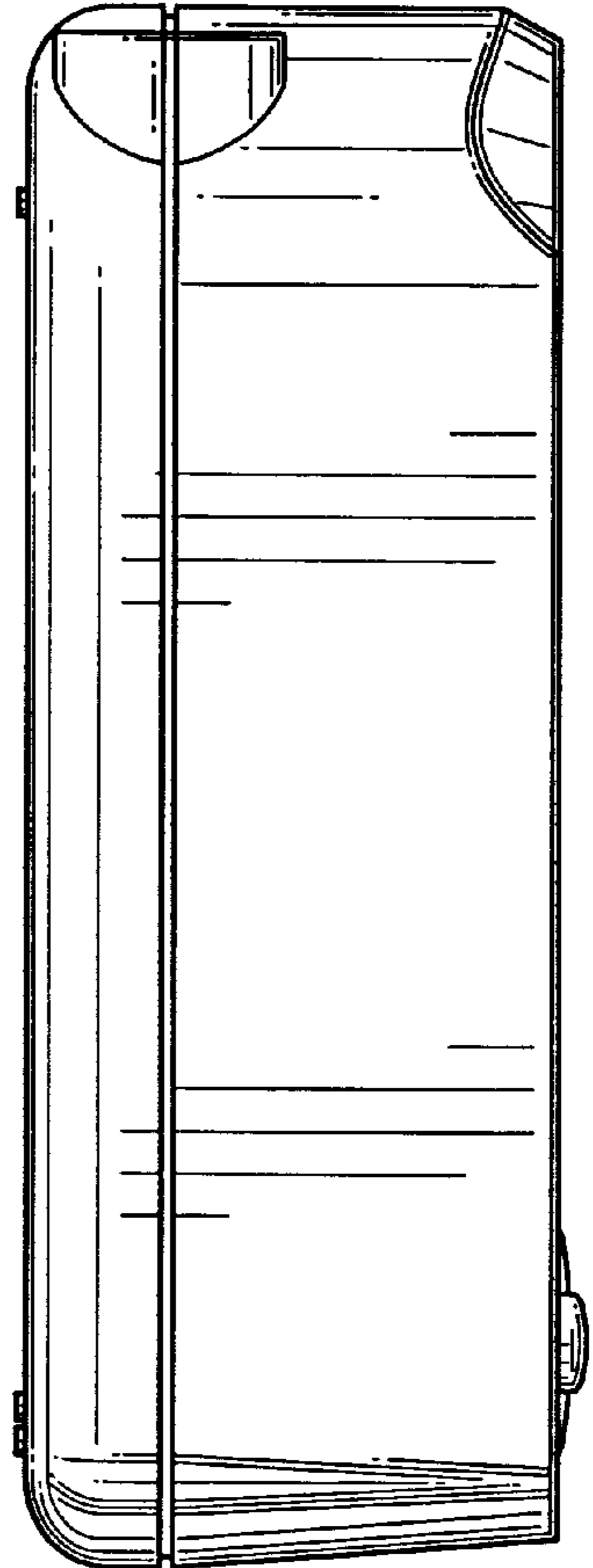

FIG. 4

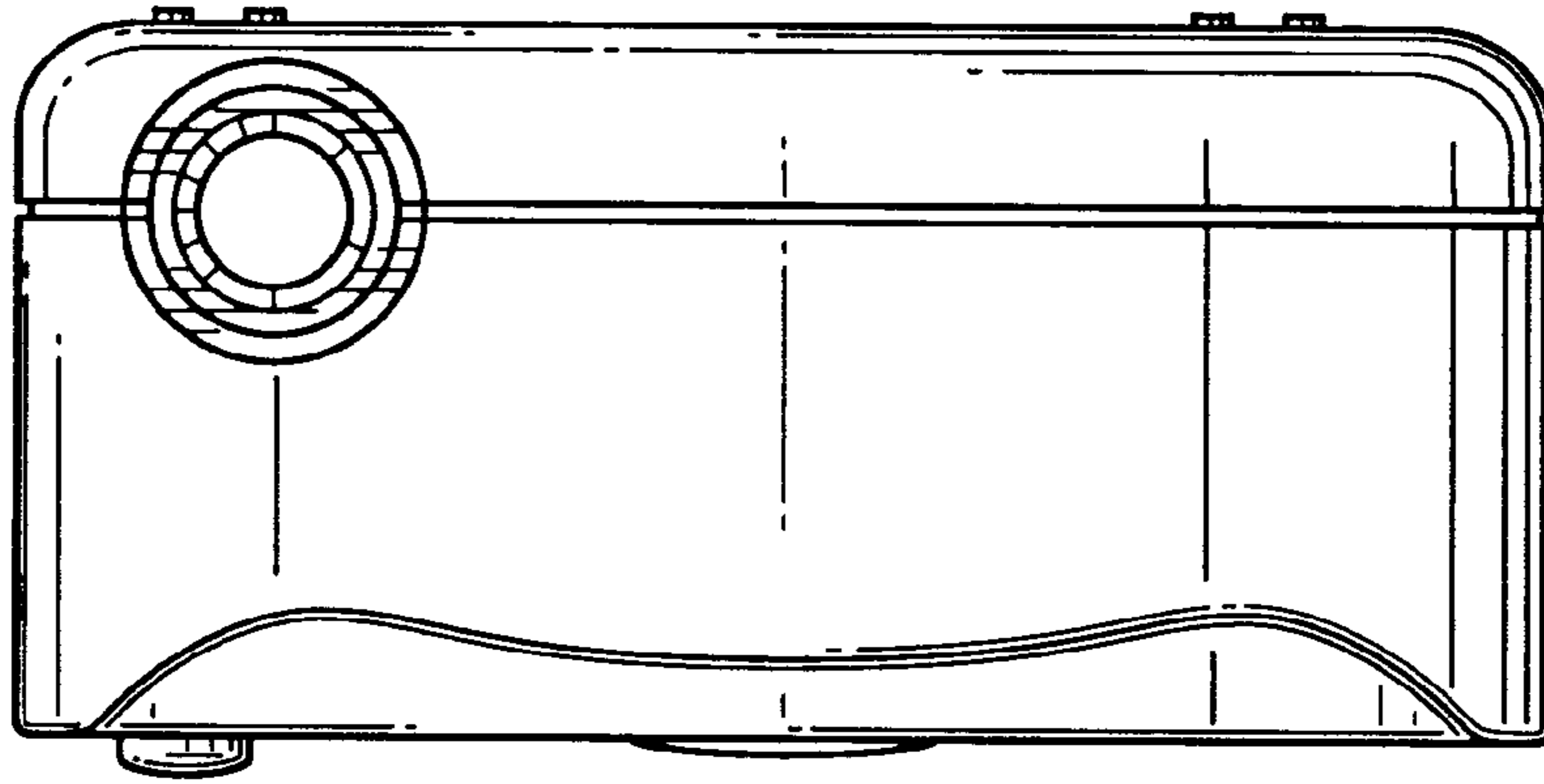

FIG. 5

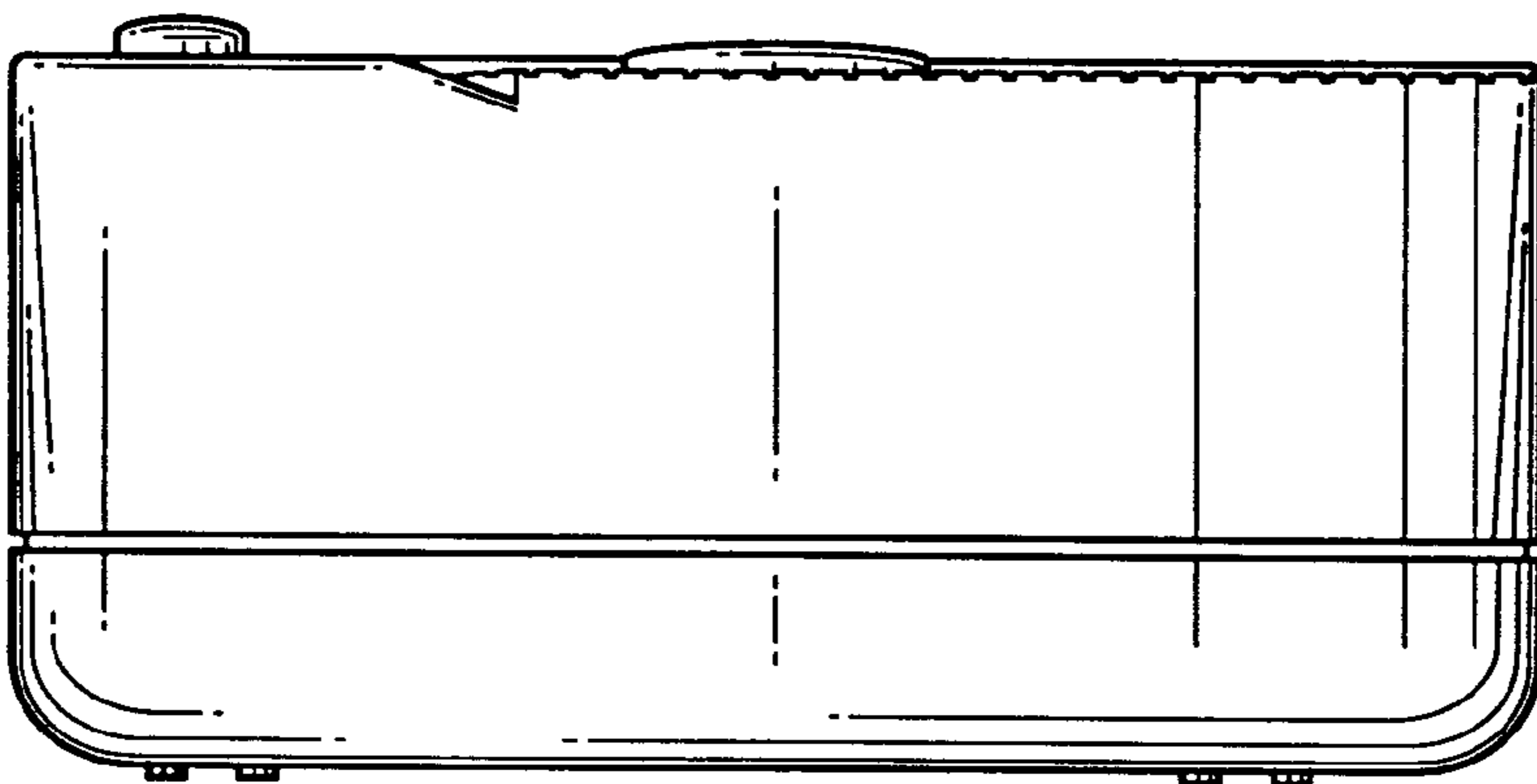

FIG. 6