



US00D426205S

United States Patent [19]
Knoop

[11] **Patent Number: Des. 426,205**
[45] **Date of Patent: ** Jun. 6, 2000**

[54] **BULLETIN BOARD EASEL ASSEMBLY FOR A COMPUTER MONITOR**

[76] Inventor: **Dale R. Knoop**, P.O. Box 6871,
Leawood, Kans. 66206-6871

[**] Term: **14 Years**

[21] Appl. No.: **29/104,408**

[22] Filed: **May 4, 1999**

[51] **LOC (7) Cl.** **14-02**

[52] **U.S. Cl.** **D14/114; D19/91**

[58] **Field of Search** D14/100, 114;
D6/314, 419; D19/65, 75, 76, 84, 88, 90,
91, 99, 100; 248/441.1, 442.2, 444.1, 447.2,
451, 452, 917-924

[56] **References Cited**

U.S. PATENT DOCUMENTS

D. 319,472	8/1991	Clyburn	D19/92
D. 359,399	6/1995	Rath	D6/419
D. 384,655	10/1997	Knoop	D14/114
4,960,257	10/1990	Waters	248/442.2
5,104,086	4/1992	Ramey, III et al.	248/442.2

Primary Examiner—Kay H. Chin

Attorney, Agent, or Firm—Shughart Thomson & Kilroy

[57] **CLAIM**

The ornamental design for a bulletin board easel assembly for a computer monitor, as shown and described.

DESCRIPTION

FIG. 1 is a top, front, right side perspective view of a bulletin board easel assembly for a computer monitor, showing my new design;

FIG. 2 is a front elevational view thereof;

FIG. 3 is a rear elevational view thereof;

FIG. 4 is a right side elevational view thereof, the left side being a mirror image thereof;

FIG. 5 is a top plan view thereof;

FIG. 6 is a bottom plan view thereof;

FIG. 7 is a top, front, right side perspective view of a second embodiment of the bulletin board easel assembly for a computer monitor;

FIG. 8 is a front elevational view thereof;

FIG. 9 is a rear elevational view thereof;

FIG. 10 is a right side elevational view thereof, the left side being a mirror image thereof;

FIG. 11 is a top plan view thereof; and,

FIG. 12 is a bottom plan view thereof.

1 Claim, 4 Drawing Sheets

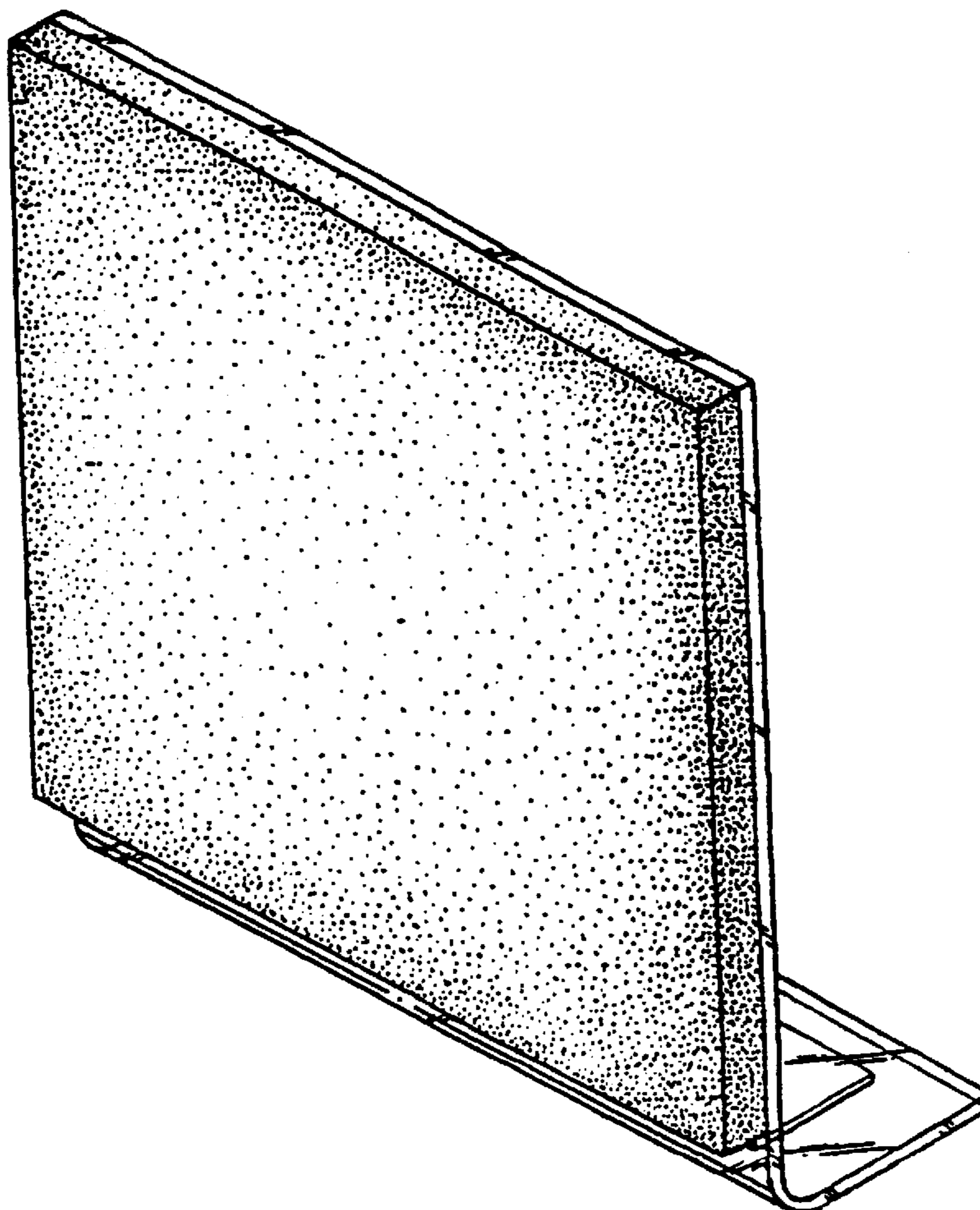

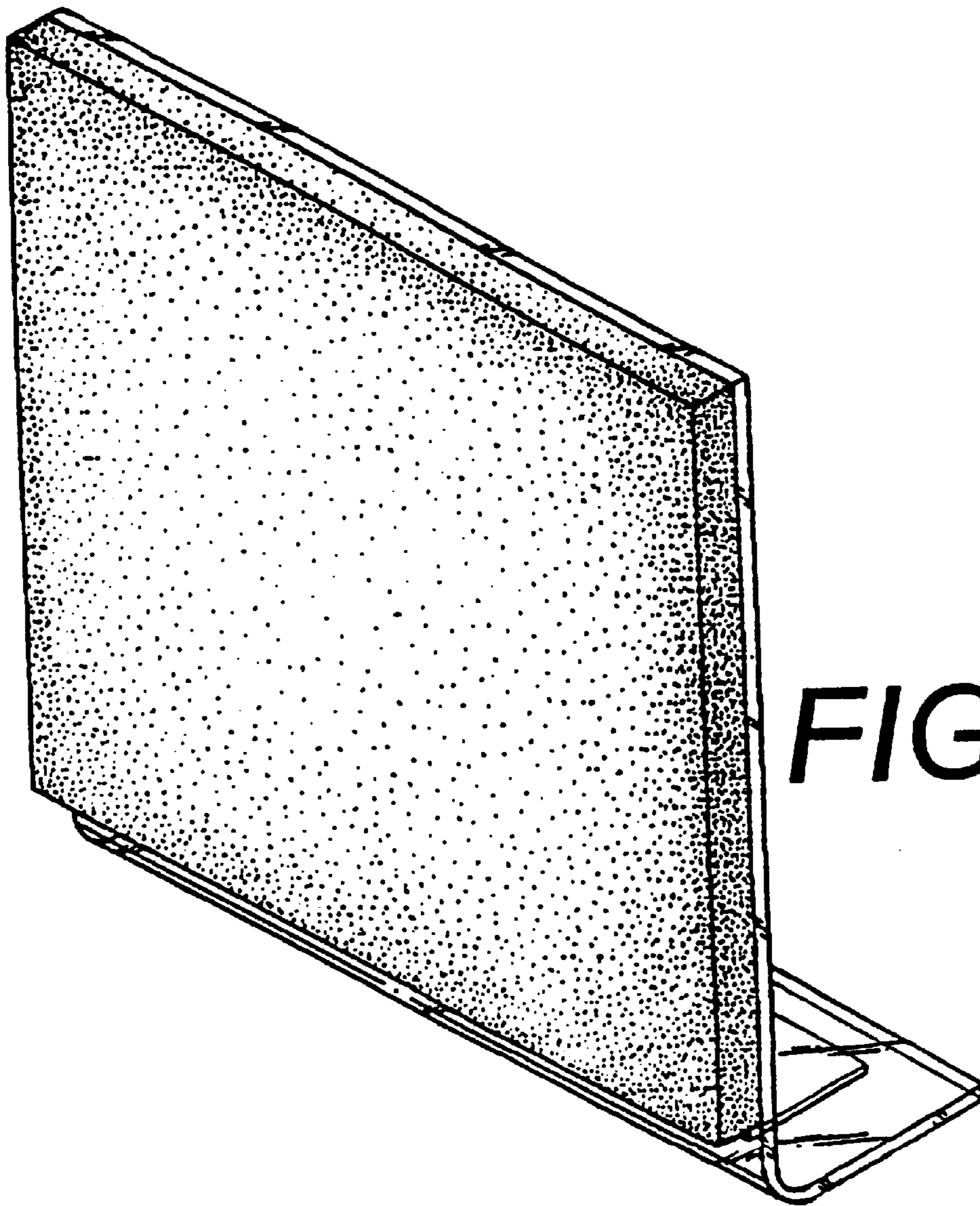

FIG. 1

FIG. 4

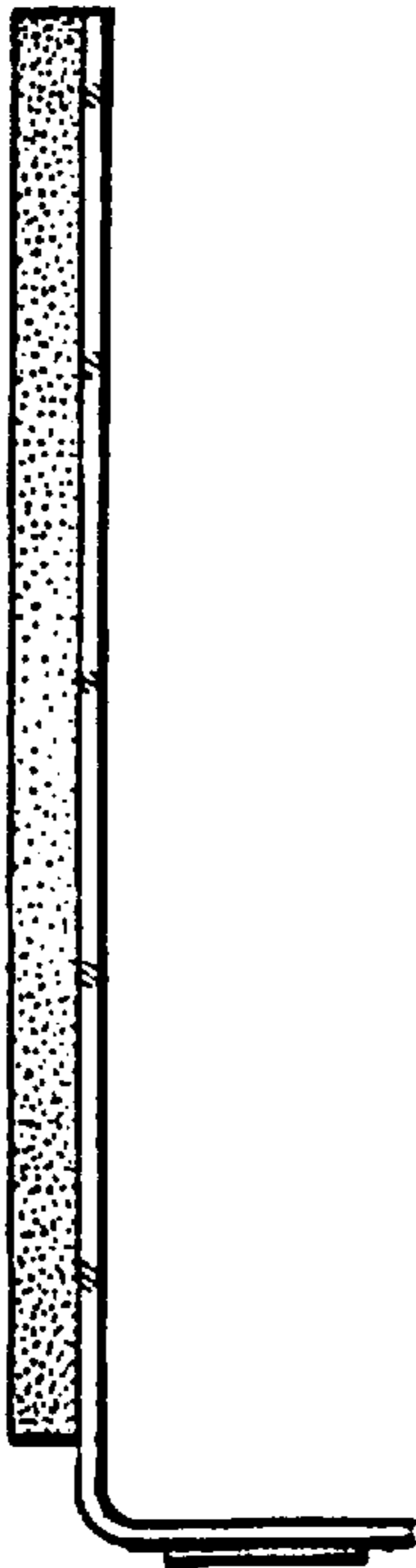

FIG. 2

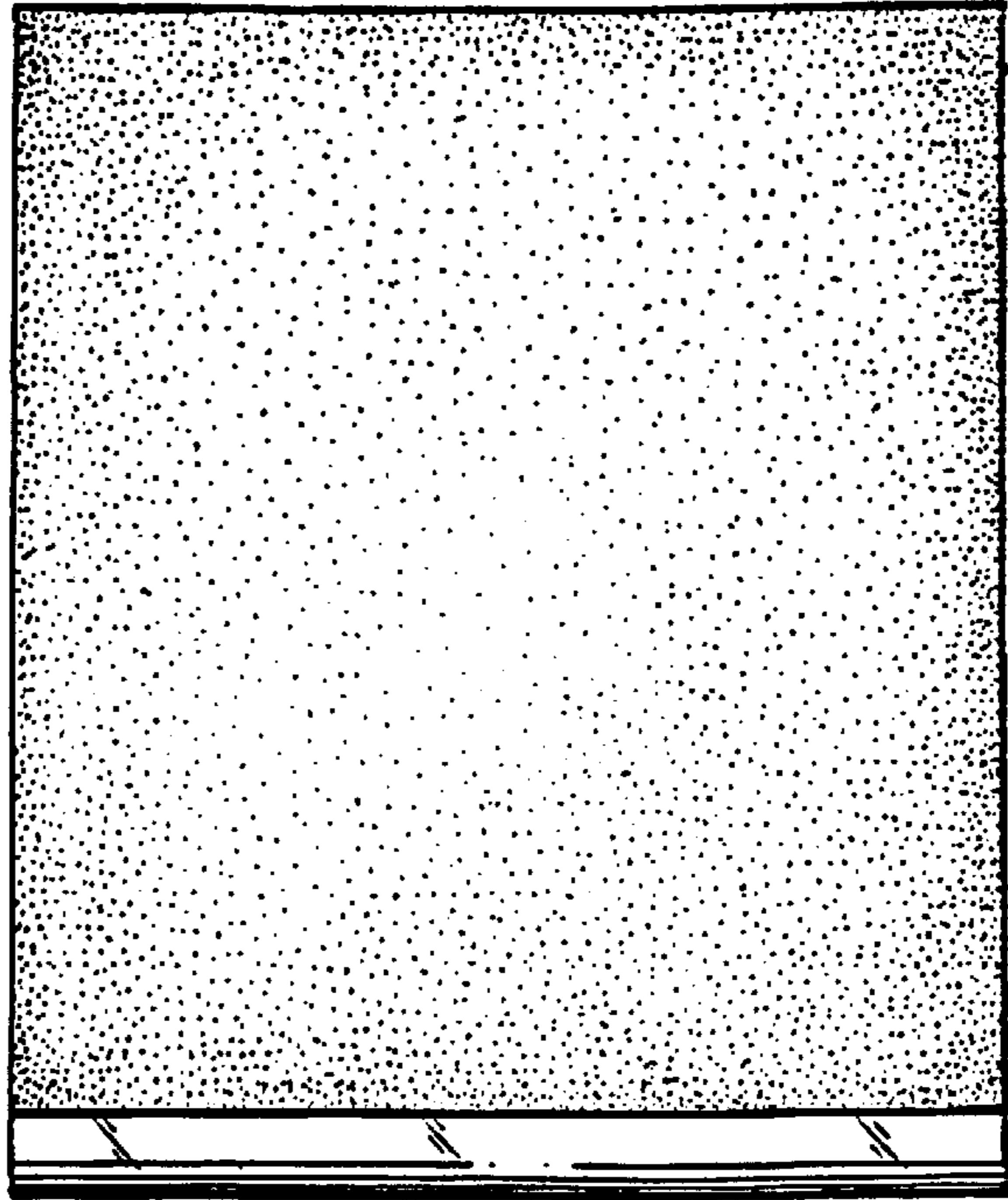

FIG. 5

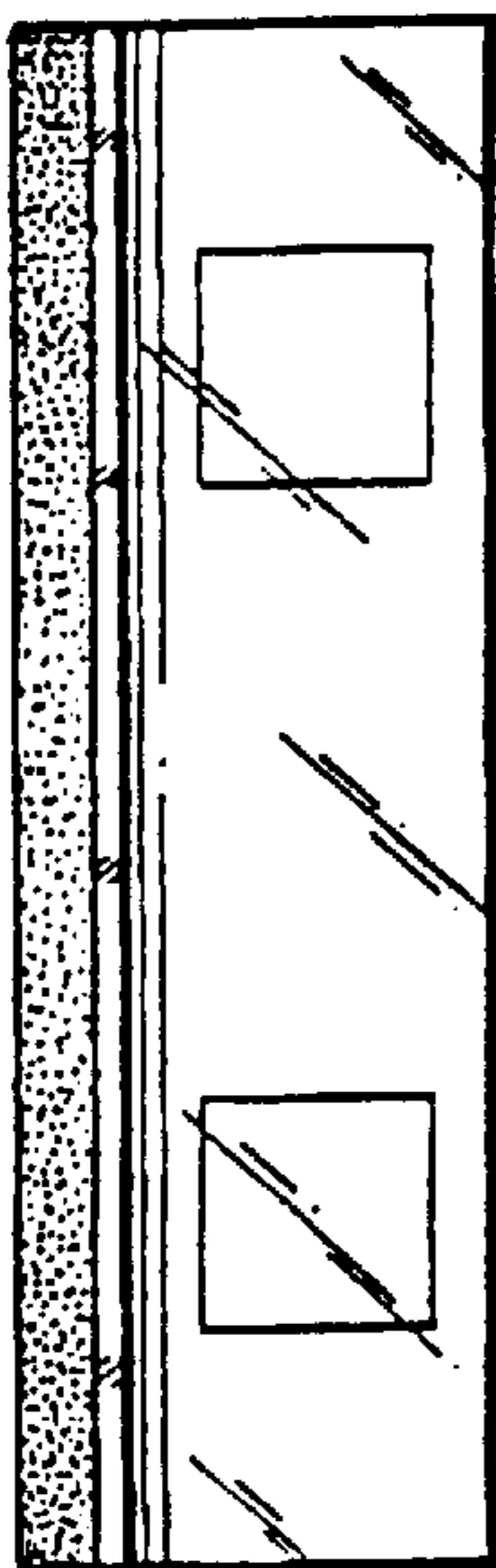

FIG. 3

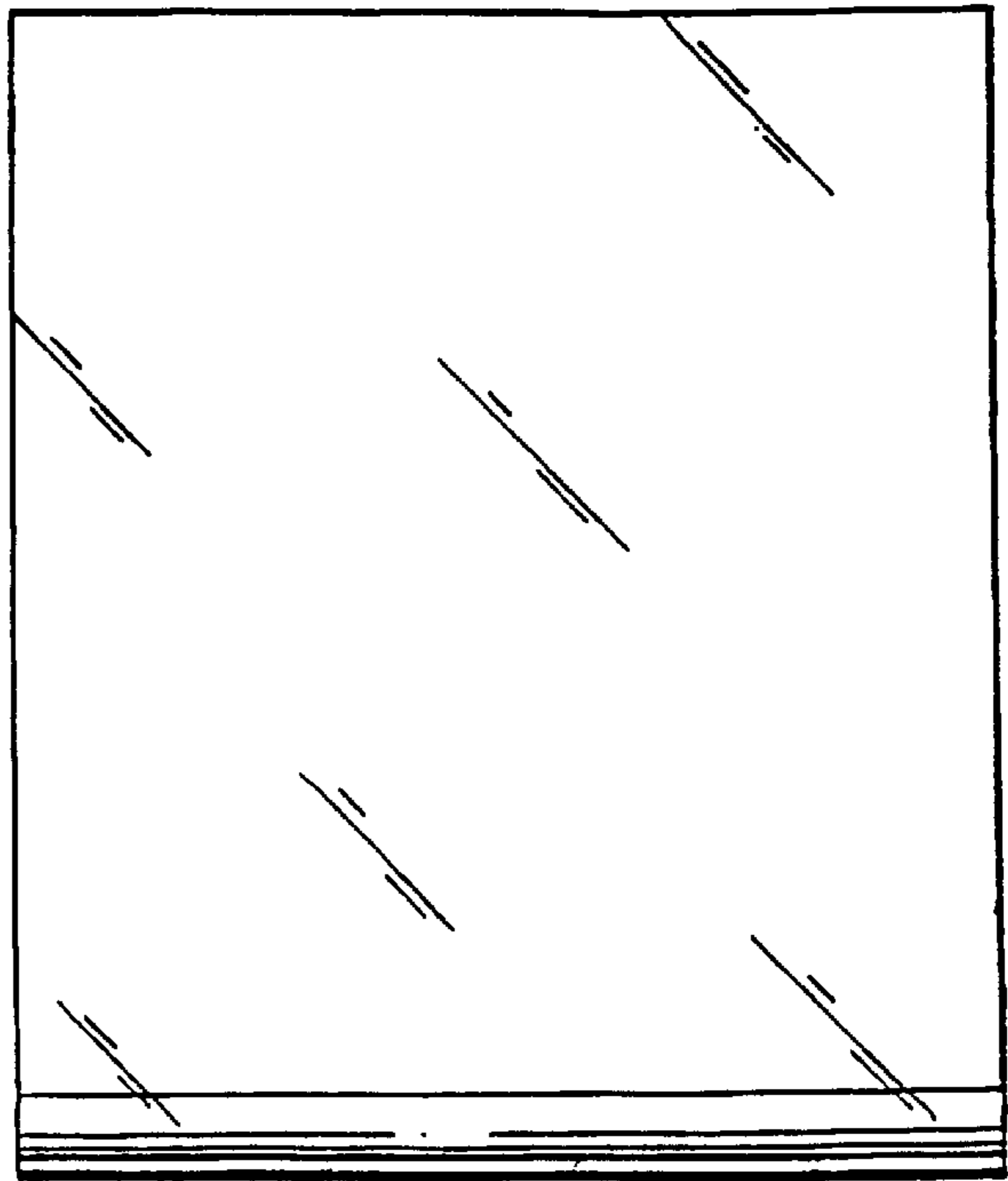

FIG. 6

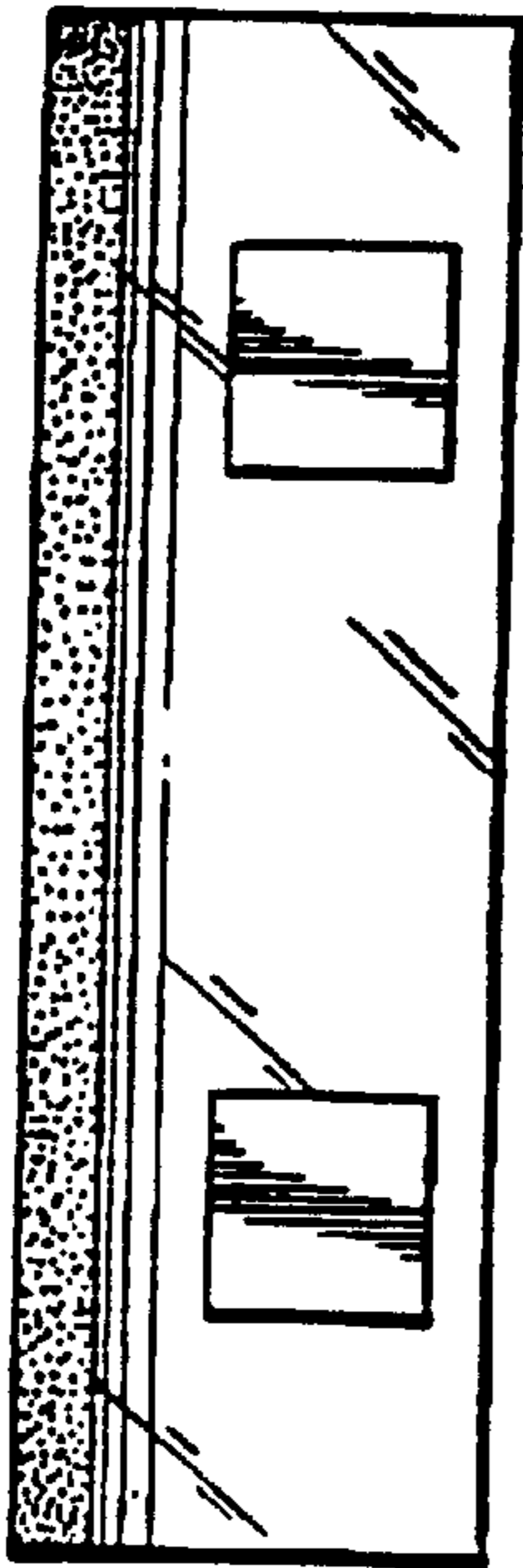

FIG. 7

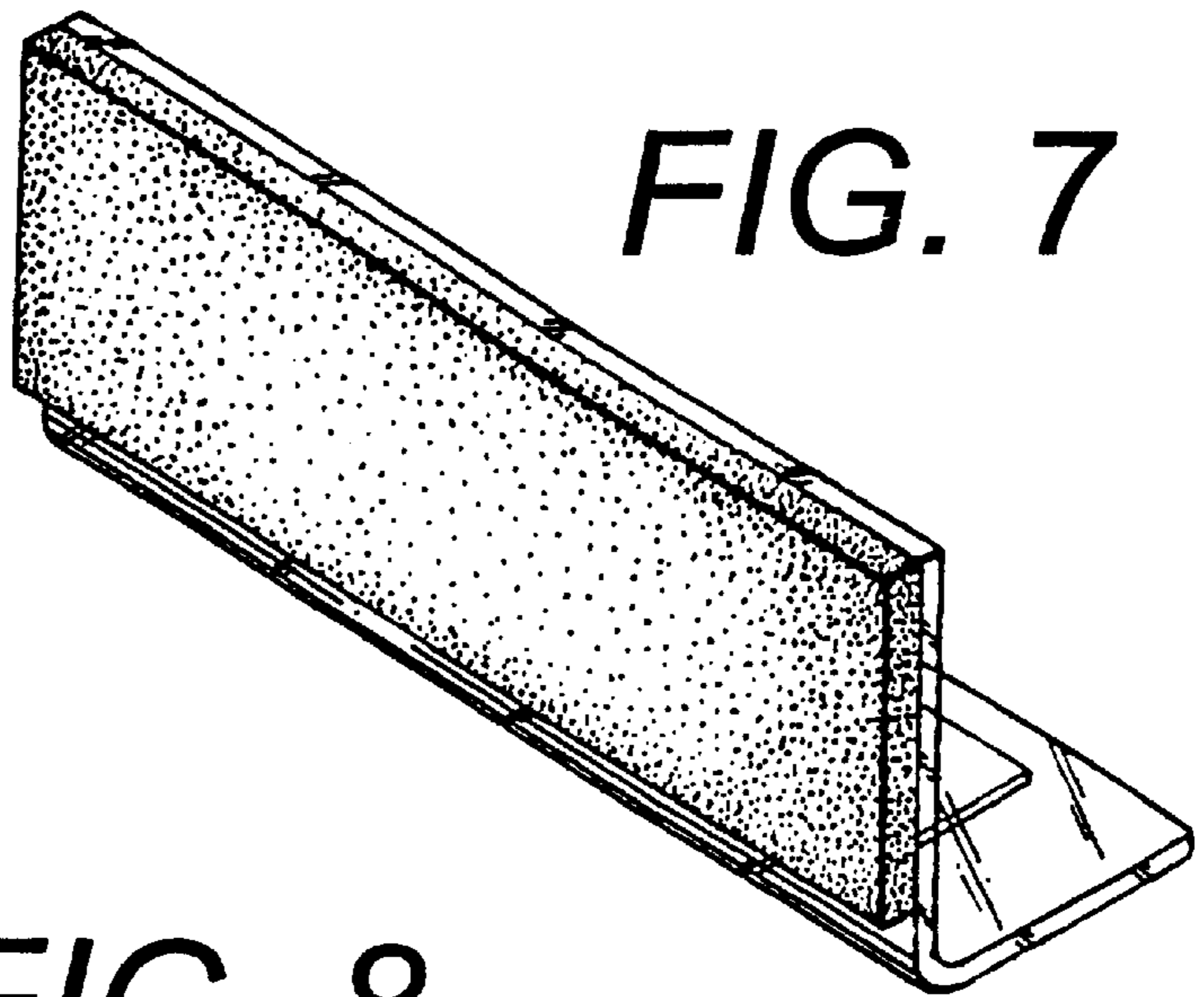

FIG. 8

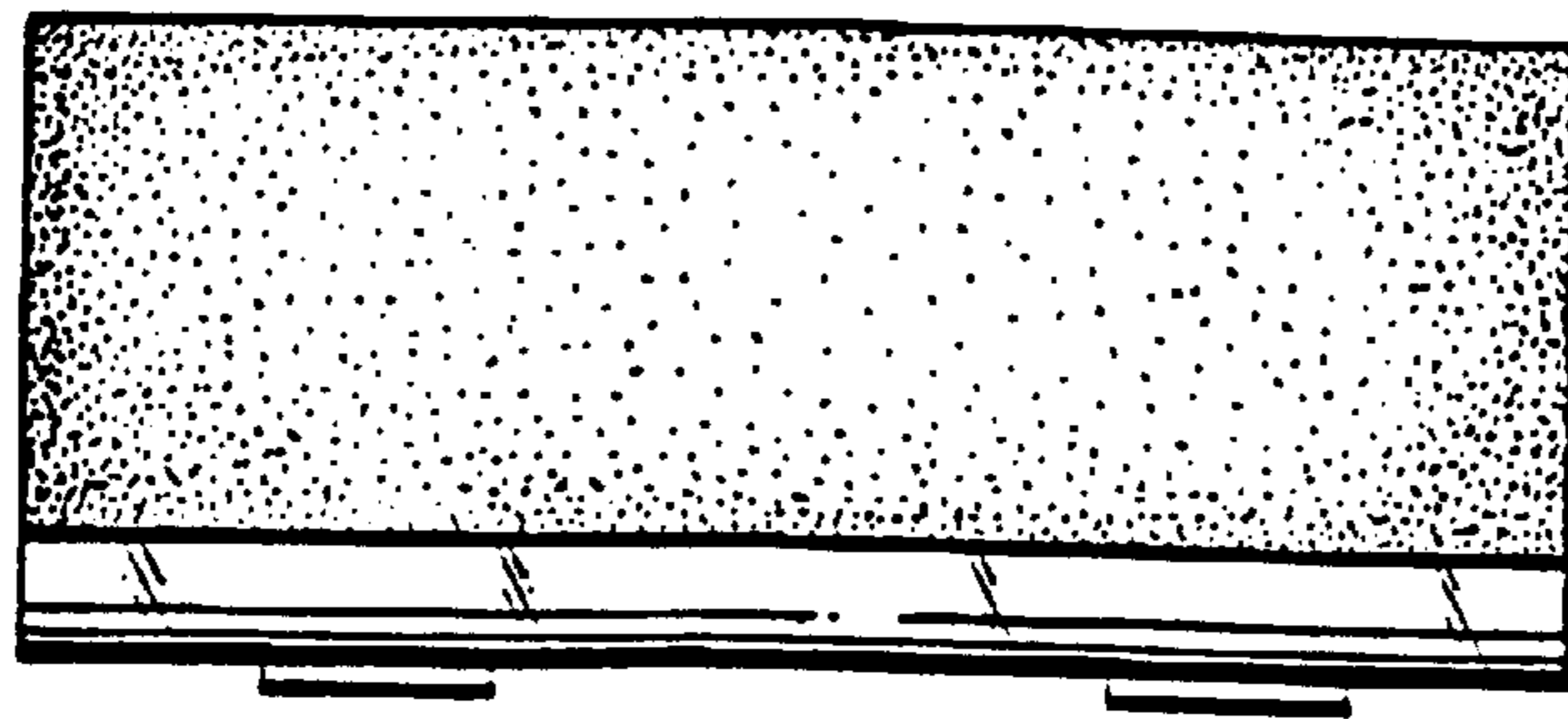

FIG. 10



FIG. 9

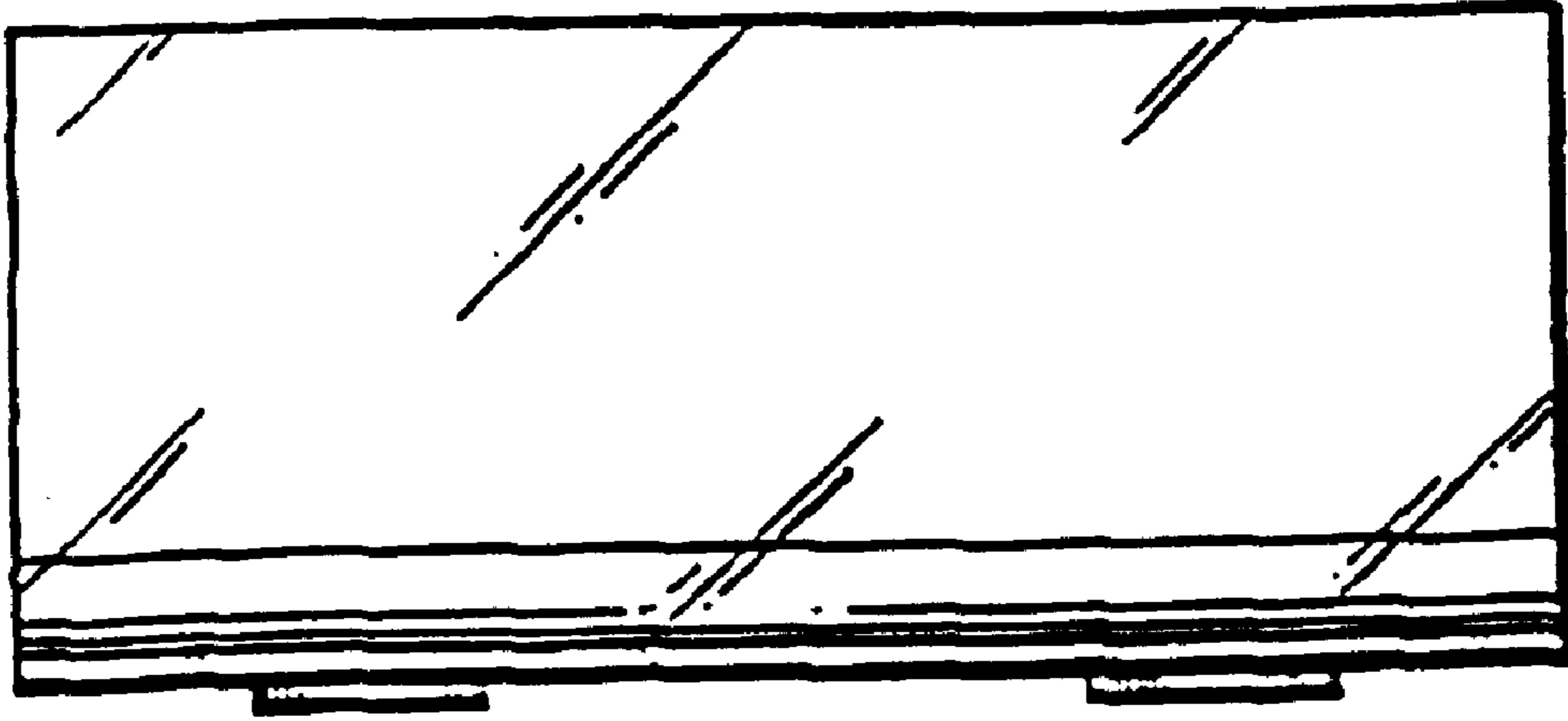

FIG. 11

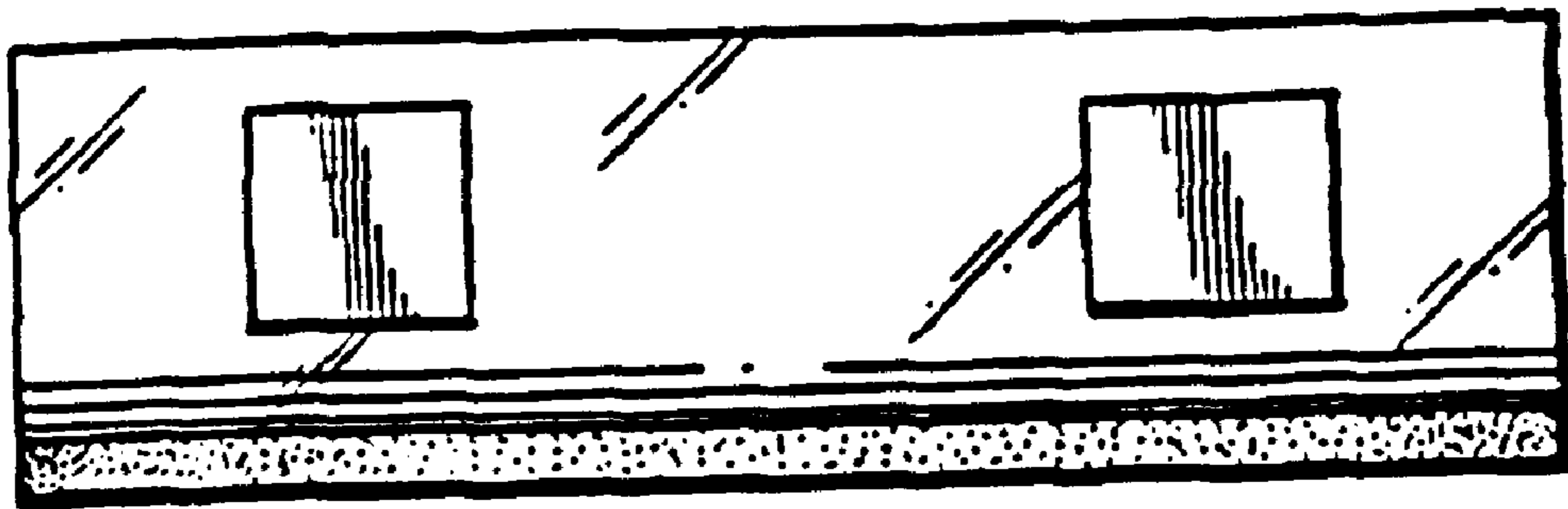
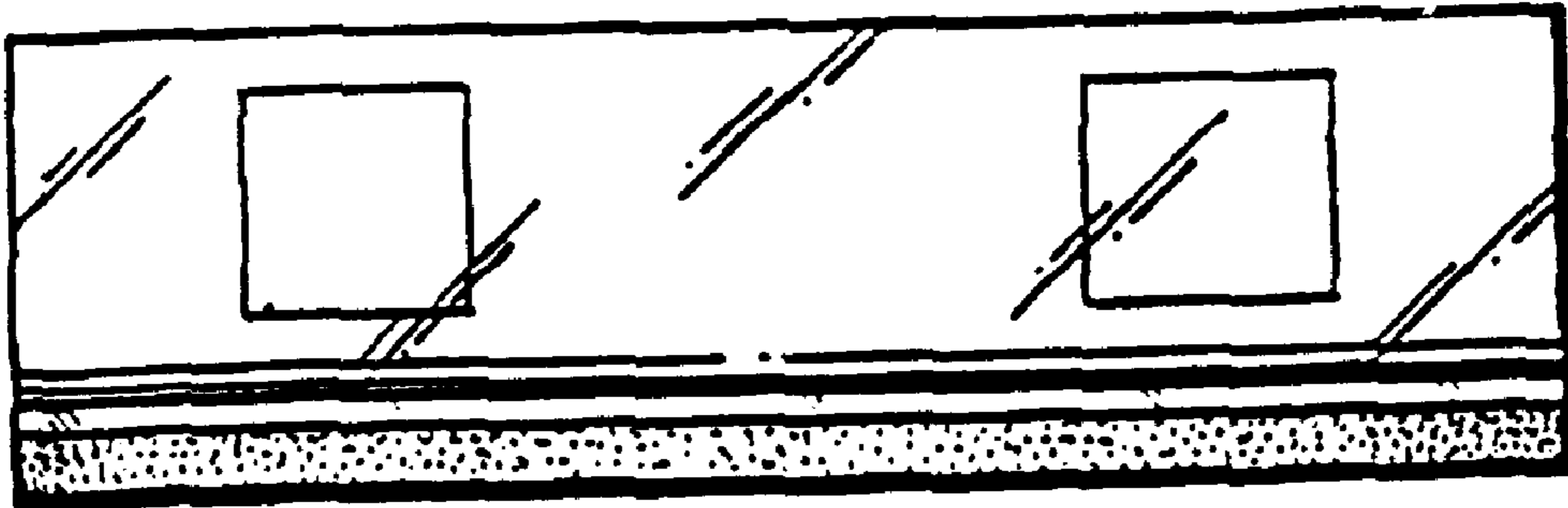

FIG. 12