



US00D426141S

**United States Patent** [19]  
**Krey**

[11] **Patent Number: Des. 426,141**  
[45] **Date of Patent: \*\* Jun. 6, 2000**

[54] **JUVENILE FURNITURE SAFETY BRACKET**

*Attorney, Agent, or Firm—Wood, Herron & Evans, LLP*

[75] Inventor: **Walter Krey**, Chicago, Ill.

[57] **CLAIM**

[73] Assignee: **L&P Property Management Company**, South Gate, Calif.

The ornamental design for a juvenile furniture safety bracket, as shown and described.

[\*\*] Term: **14 Years**

**DESCRIPTION**

[21] Appl. No.: **29/103,683**

[22] Filed: **Apr. 19, 1999**

[51] **LOC (7) Cl.** ..... **08-05**

[52] **U.S. Cl.** ..... **D8/354**

[58] **Field of Search** ..... D8/349, 354; 5/8, 5/9.1; 248/72, 214; 182/206; D6/491, 503

FIG. 1 is a perspective view of the bunk bed safety rail bracket showing my new design, with the broken line showing of a fragmented bunk bed being for illustrative purposes only and forming no part of the claimed design; FIG. 2 is an enlarged perspective view of one side thereof; FIG. 3 is an enlarged perspective view of the opposite side thereof; FIG. 4 is a front elevational view thereof; FIG. 5 is a right side elevational view thereof; FIG. 6 is a left side elevational view thereof; FIG. 7 is a rear elevational view thereof; FIG. 8 is a top plan view thereof; and, FIG. 9 is a bottom plan view thereof.

[56] **References Cited**

**U.S. PATENT DOCUMENTS**

D. 401,839 12/1998 Krey et al. .... D8/354  
5,522,101 6/1996 Yeh ..... 5/9.1

*Primary Examiner—Holly Baynham*

**1 Claim, 2 Drawing Sheets**

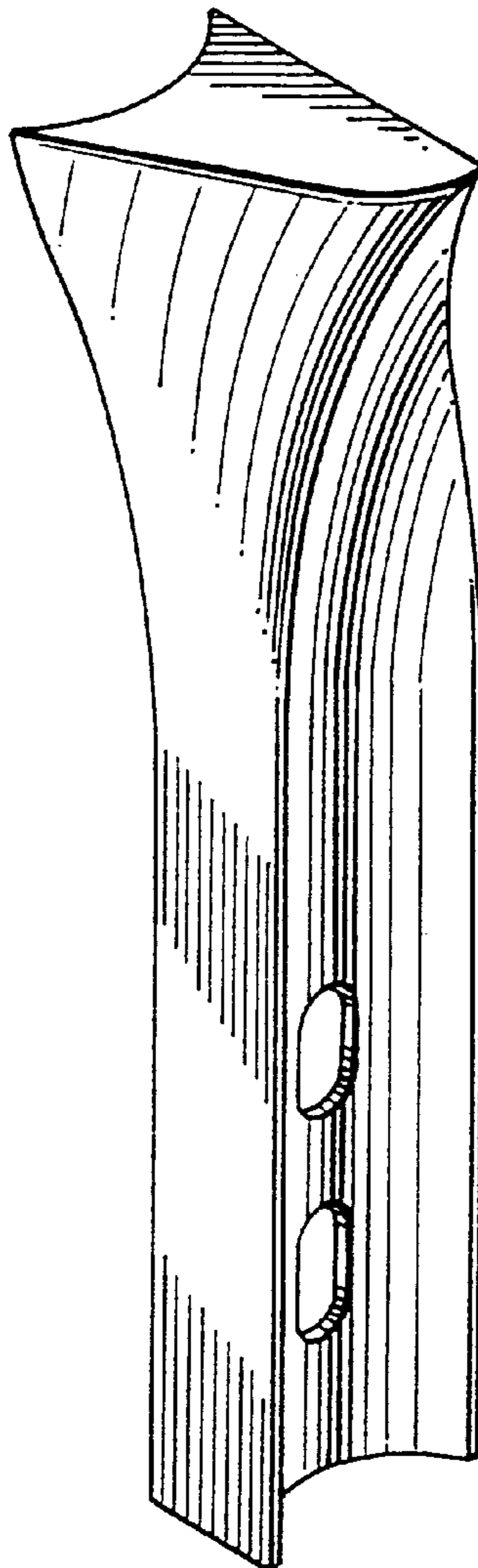

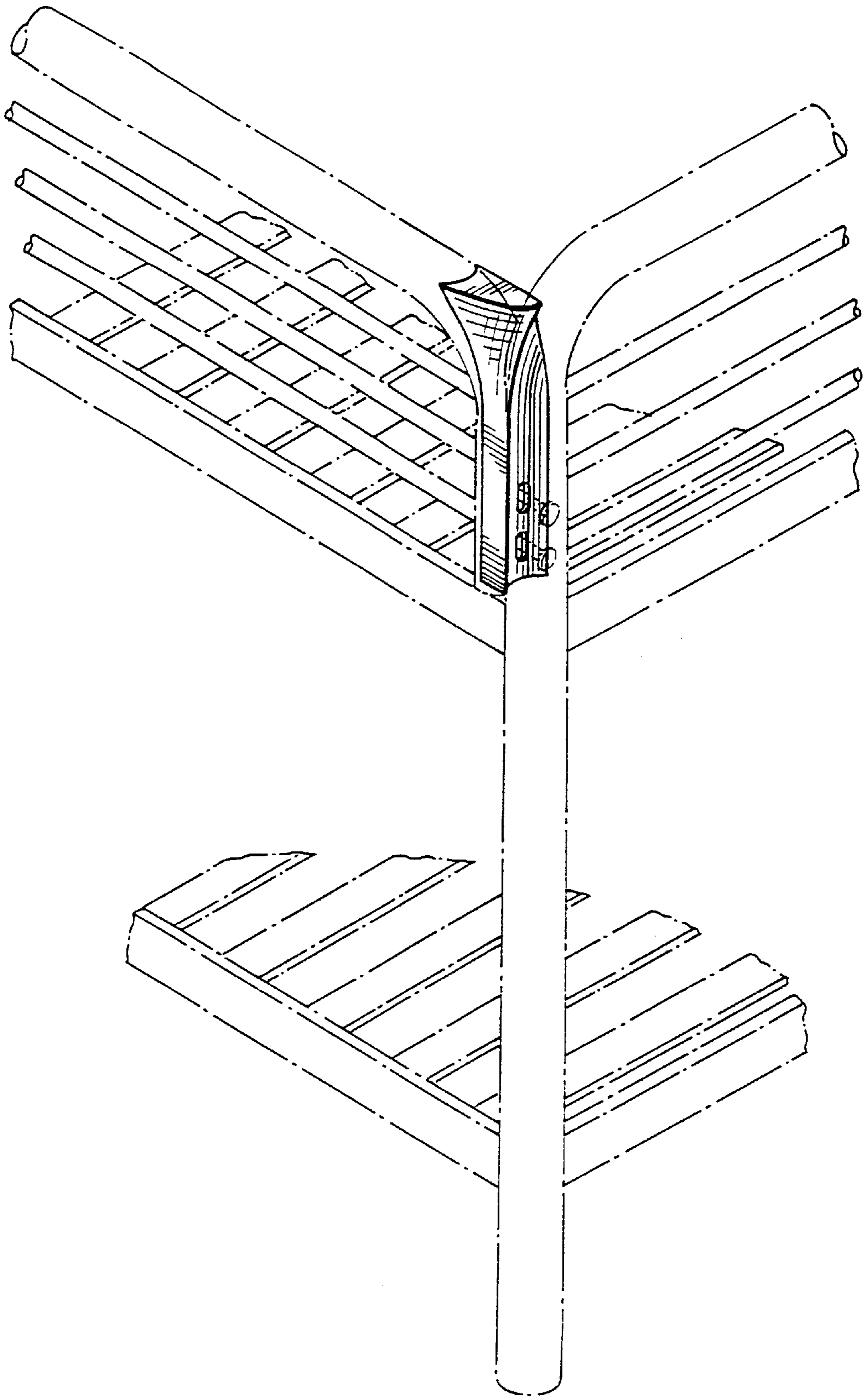

FIG. 1

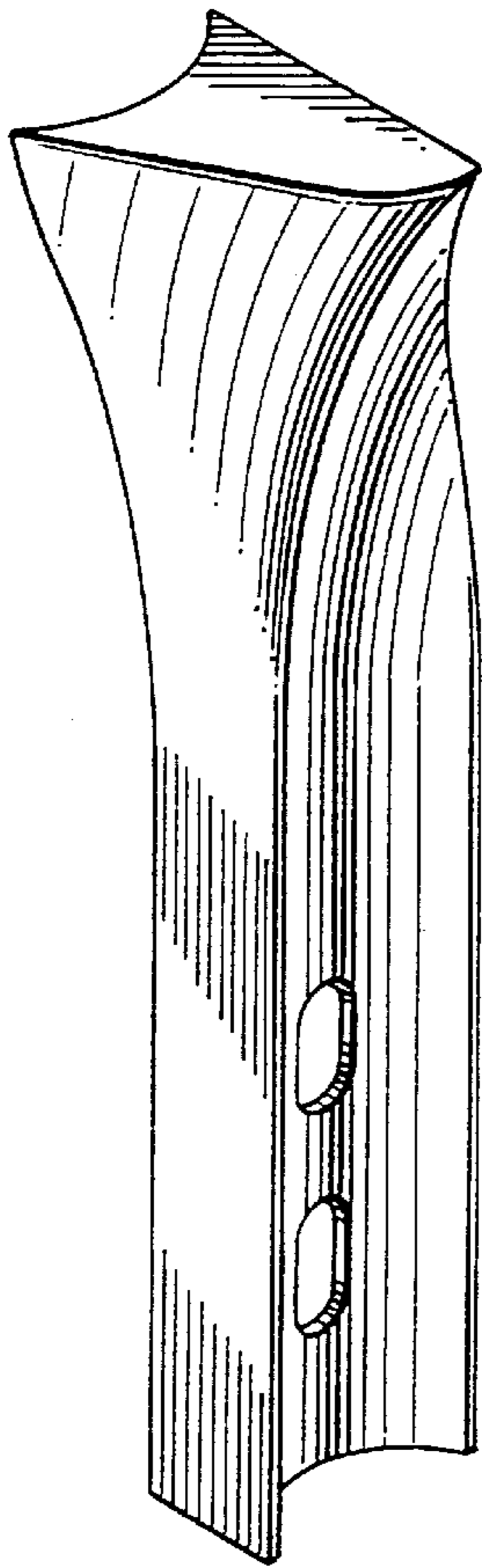

FIG. 2

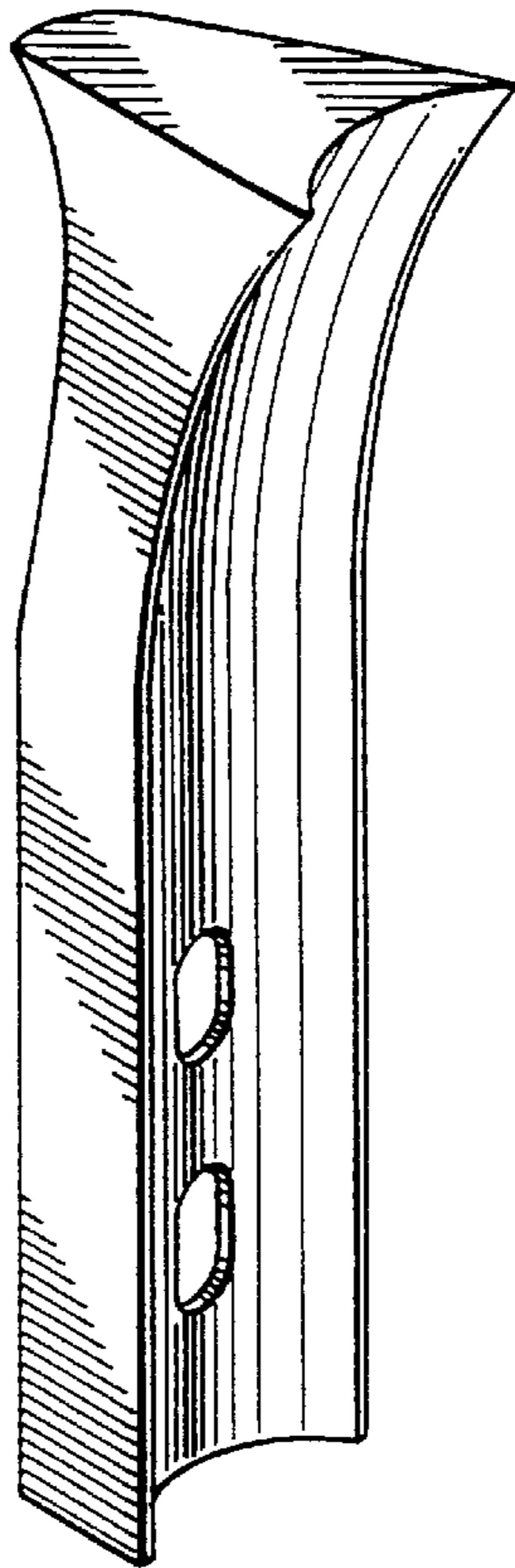

FIG. 3

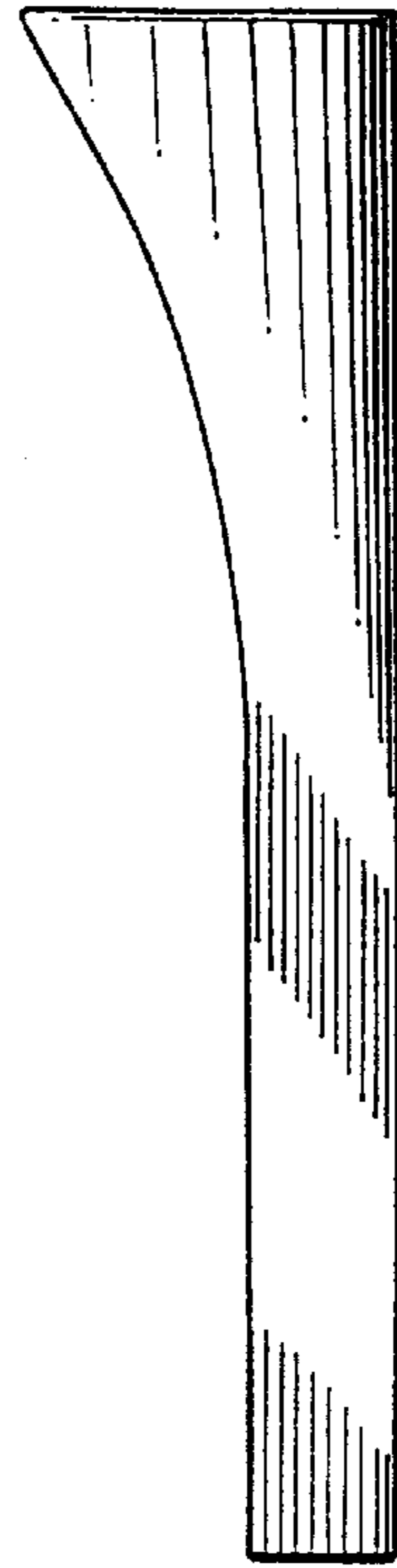

FIG. 4

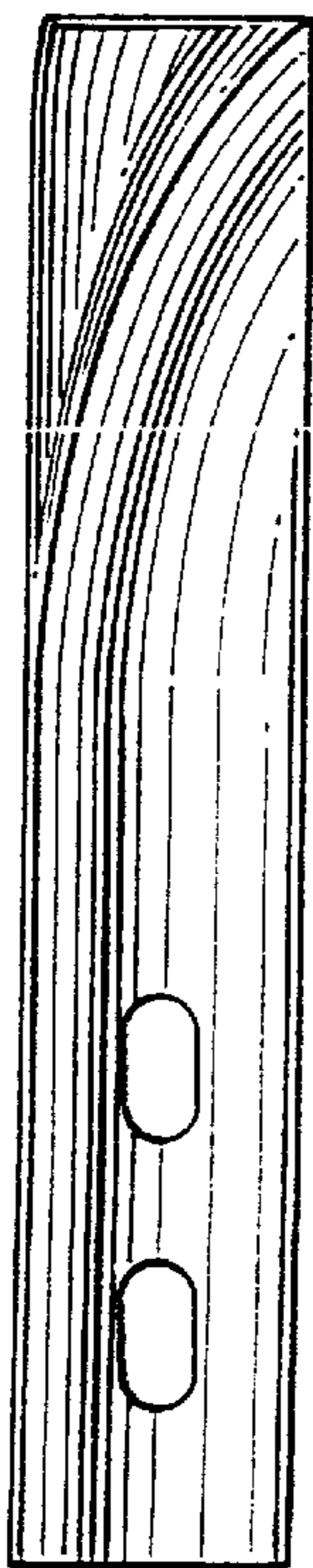

FIG. 5

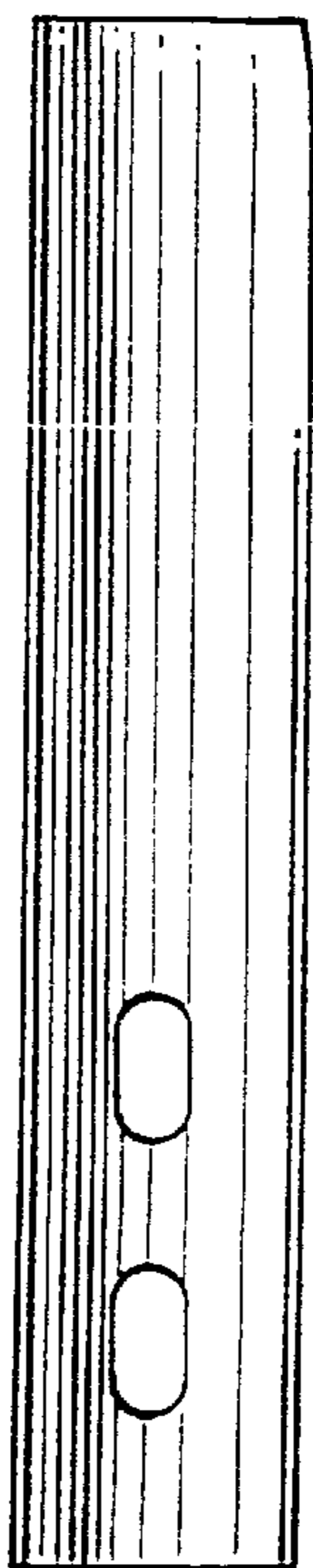

FIG. 6

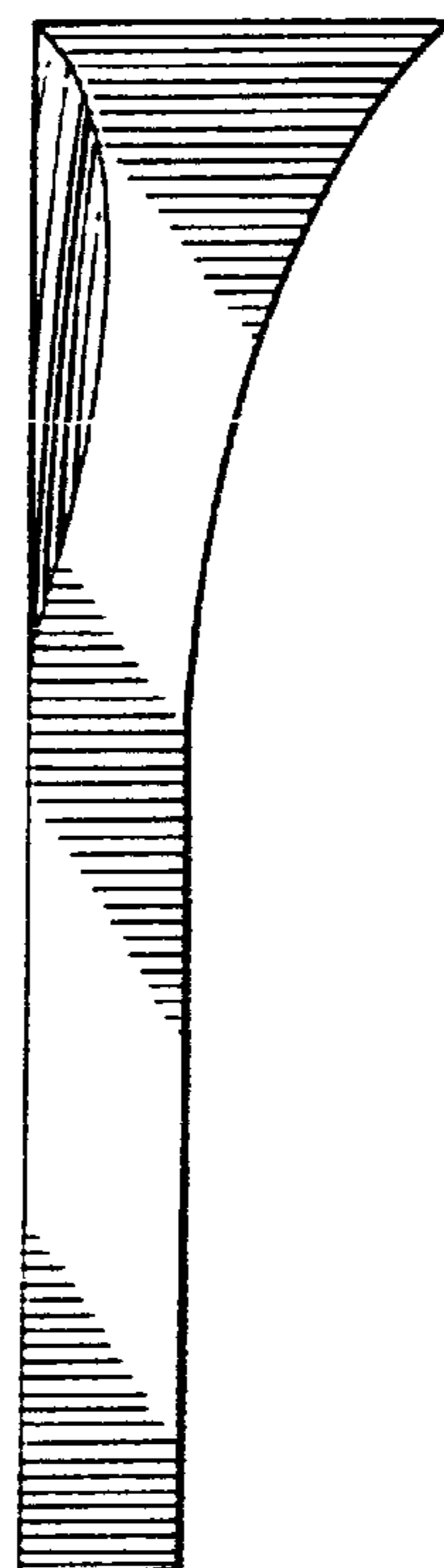

FIG. 7

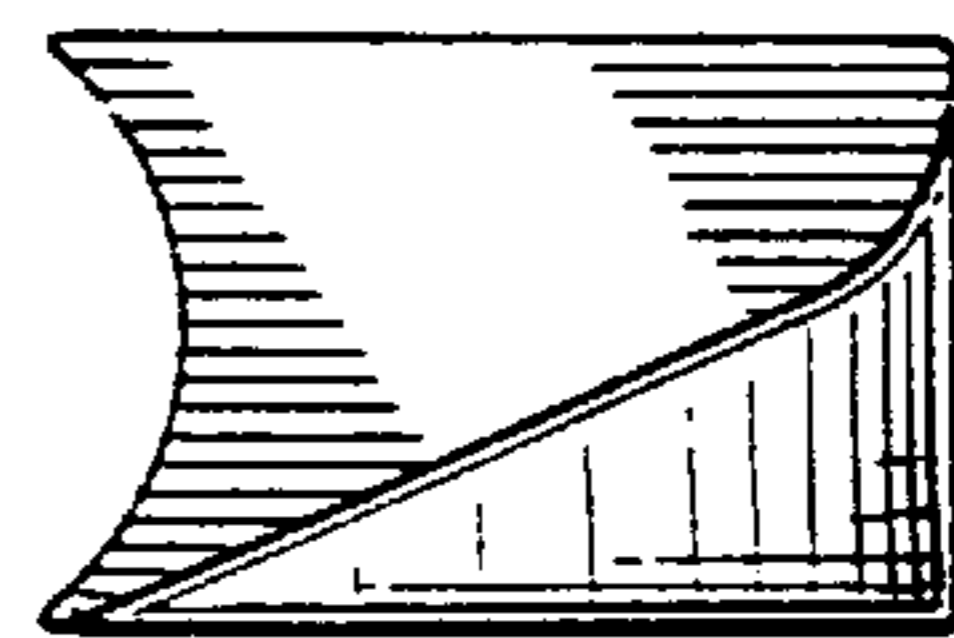

FIG. 8

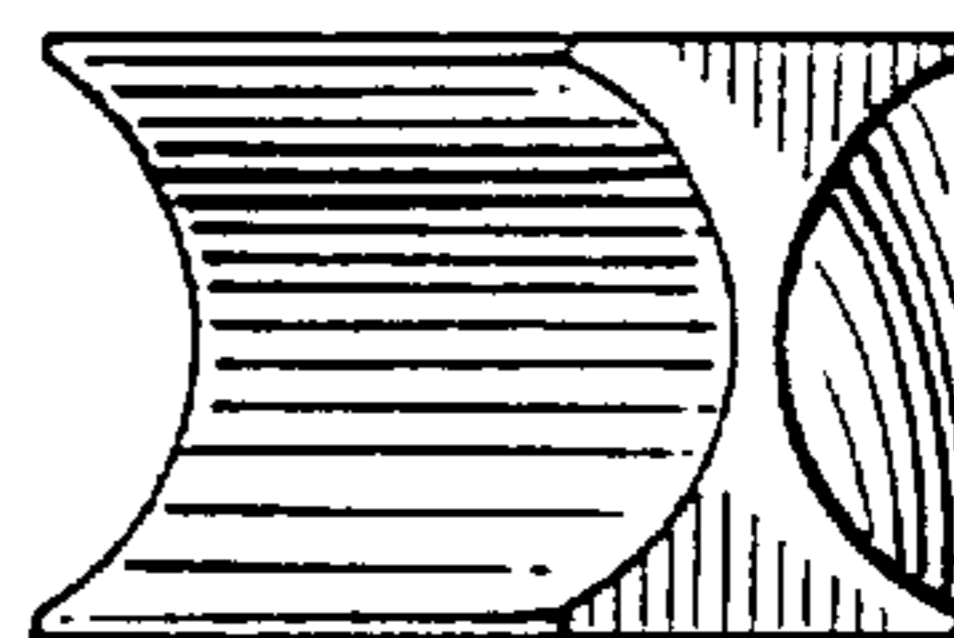

FIG. 9