



US00D426102S

United States Patent [19]

[11] Patent Number: **Des. 426,102**

Hamada et al.

[45] Date of Patent: **** Jun. 6, 2000**

[54] **MICROWAVE OVEN**

[75] Inventors: **Masanori Hamada, Osaka; Takemichi Ichimura, Nara, both of Japan**

[73] Assignee: **Matsushita Electric Industrial Co., Ltd., Japan**

[**] Term: **14 Years**

[21] Appl. No.: **29/105,304**

[22] Filed: **May 21, 1999**

[30] Foreign Application Priority Data

Dec. 24, 1998 [JP] Japan 10-37804

[51] **LOC (7) Cl.** **07-02**

[52] **U.S. Cl.** **D7/351**

[58] **Field of Search** D7/350-351, 402;
126/273 R, 273 A, 275 R, 275 E, 19 M,
21 A; 219/678, 680, 756-758

[56] References Cited

U.S. PATENT DOCUMENTS

- D. 302,226 7/1989 Kido et al. D7/351
- D. 353,510 12/1994 Nakamura D7/351
- D. 353,511 12/1994 Saimen D7/351
- D. 357,159 4/1995 Mitsui et al. D7/351
- D. 380,644 7/1997 Tsuda et al. D7/351

- D. 384,545 10/1997 Wang D7/350
- D. 390,412 2/1998 Takimoto D7/351
- D. 400,047 10/1998 Takimoto et al. D7/351
- D. 411,706 6/1999 Koike D7/351

OTHER PUBLICATIONS

Mitsubishi Denki Kabushiki Kaisha Model No. RO-MA7 catalog issued Sep., 1998.

Toshiba Model Nos. ER-FX1 and ER-FX2 catalog issued Sep., 1998.

Primary Examiner—Ruth McInroy

Attorney, Agent, or Firm—Saidman DesignLaw Group

[57] CLAIM

The ornamental design for a microwave oven, as shown and described.

DESCRIPTION

FIG. 1 is a perspective view of the top, front and right side of a microwave oven showing our new design;

FIG. 2 is a front view thereof;

FIG. 3 is a top plan view thereof;

FIG. 4 is a bottom view thereof;

FIG. 5 is a right side view thereof;

FIG. 6 is a left side view thereof; and,

FIG. 7 is a rear view thereof.

1 Claim, 4 Drawing Sheets

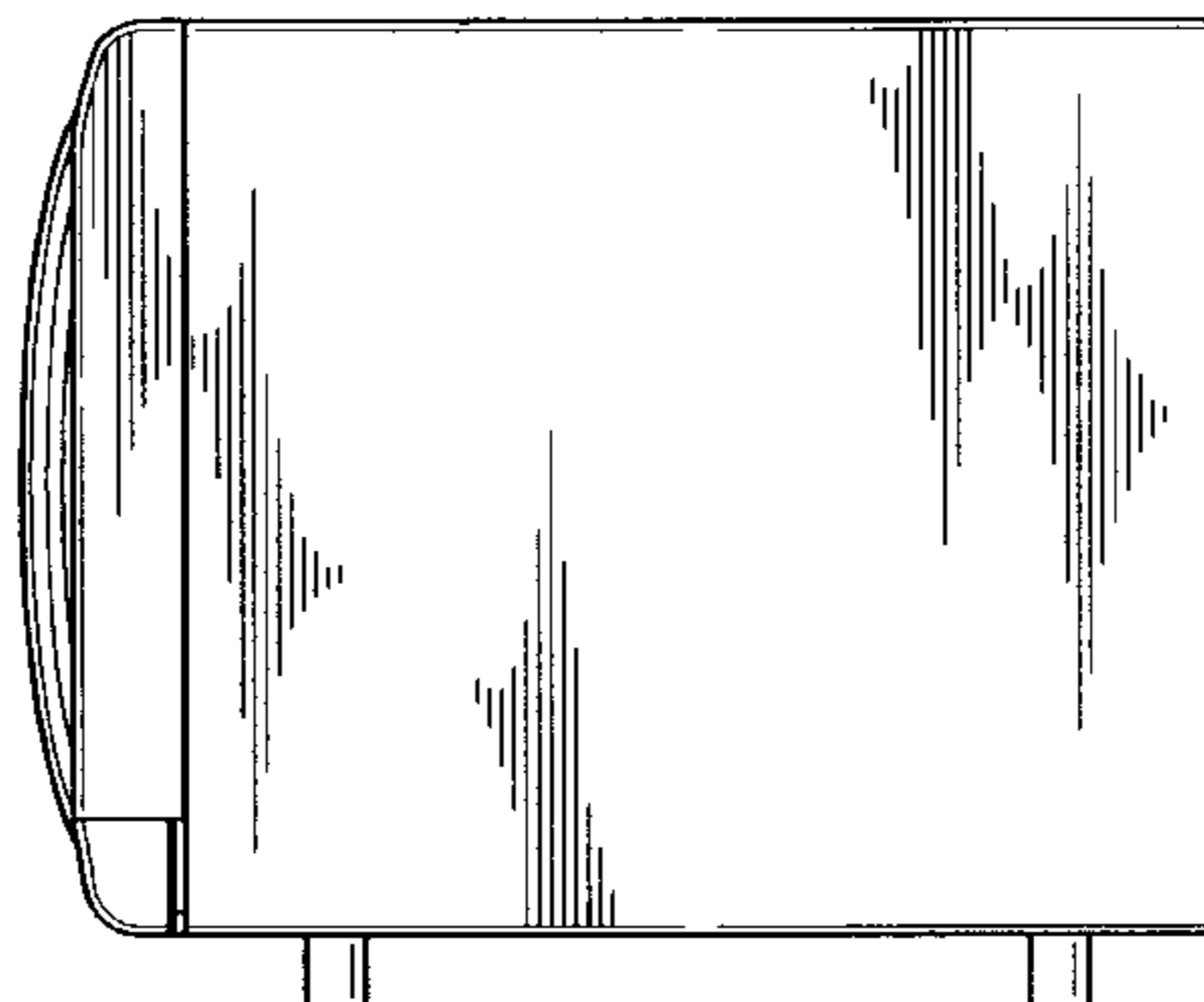
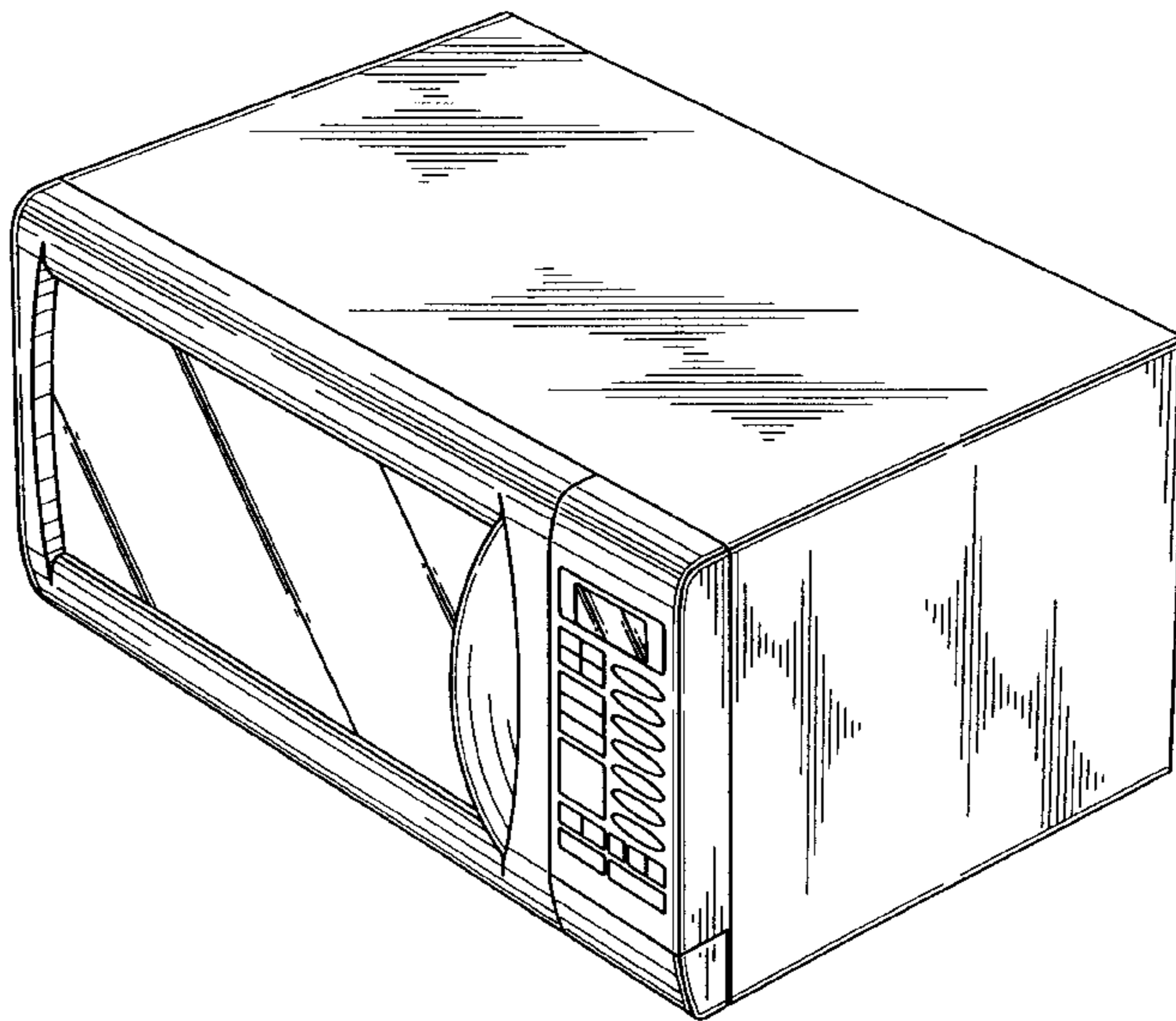

FIG. 1

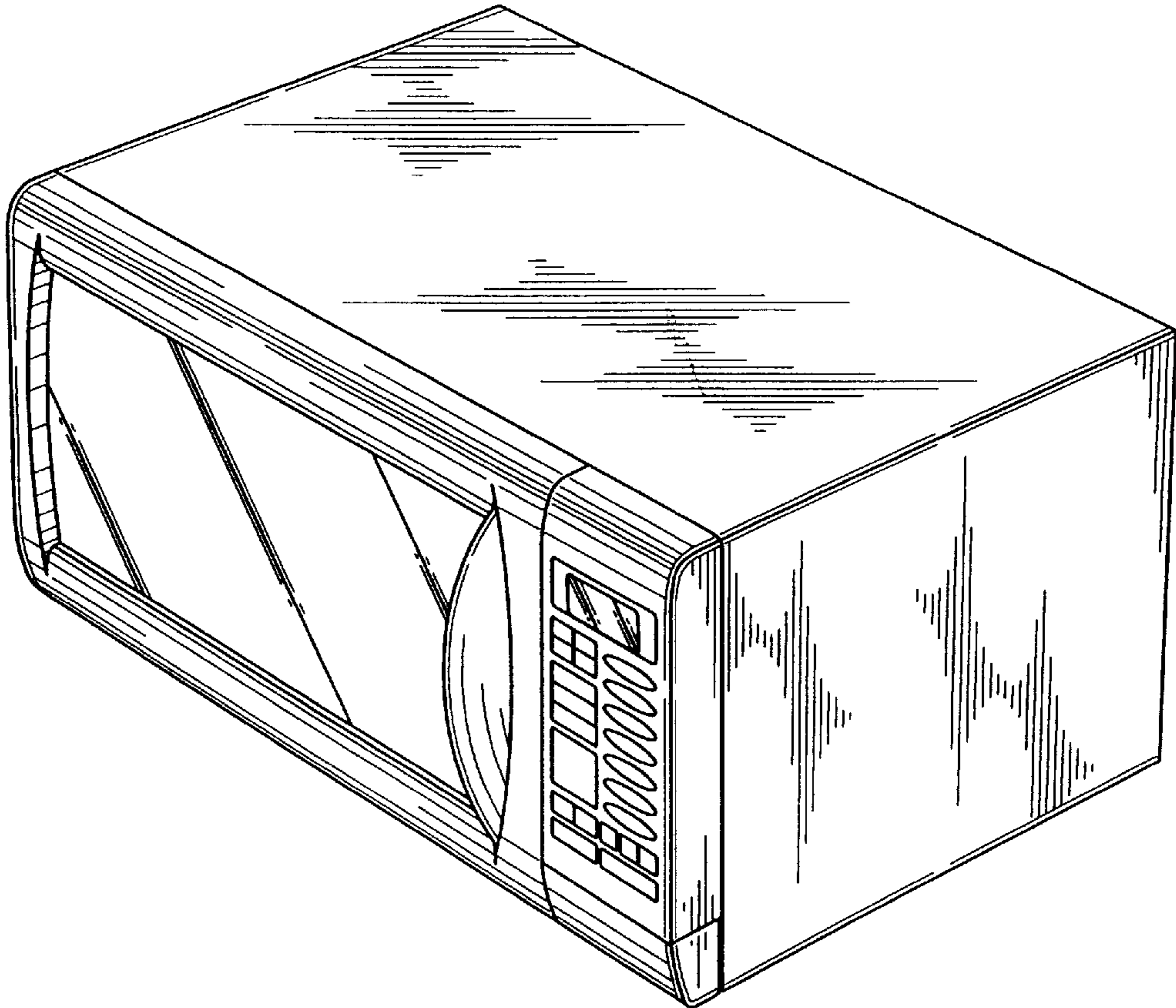

FIG. 2

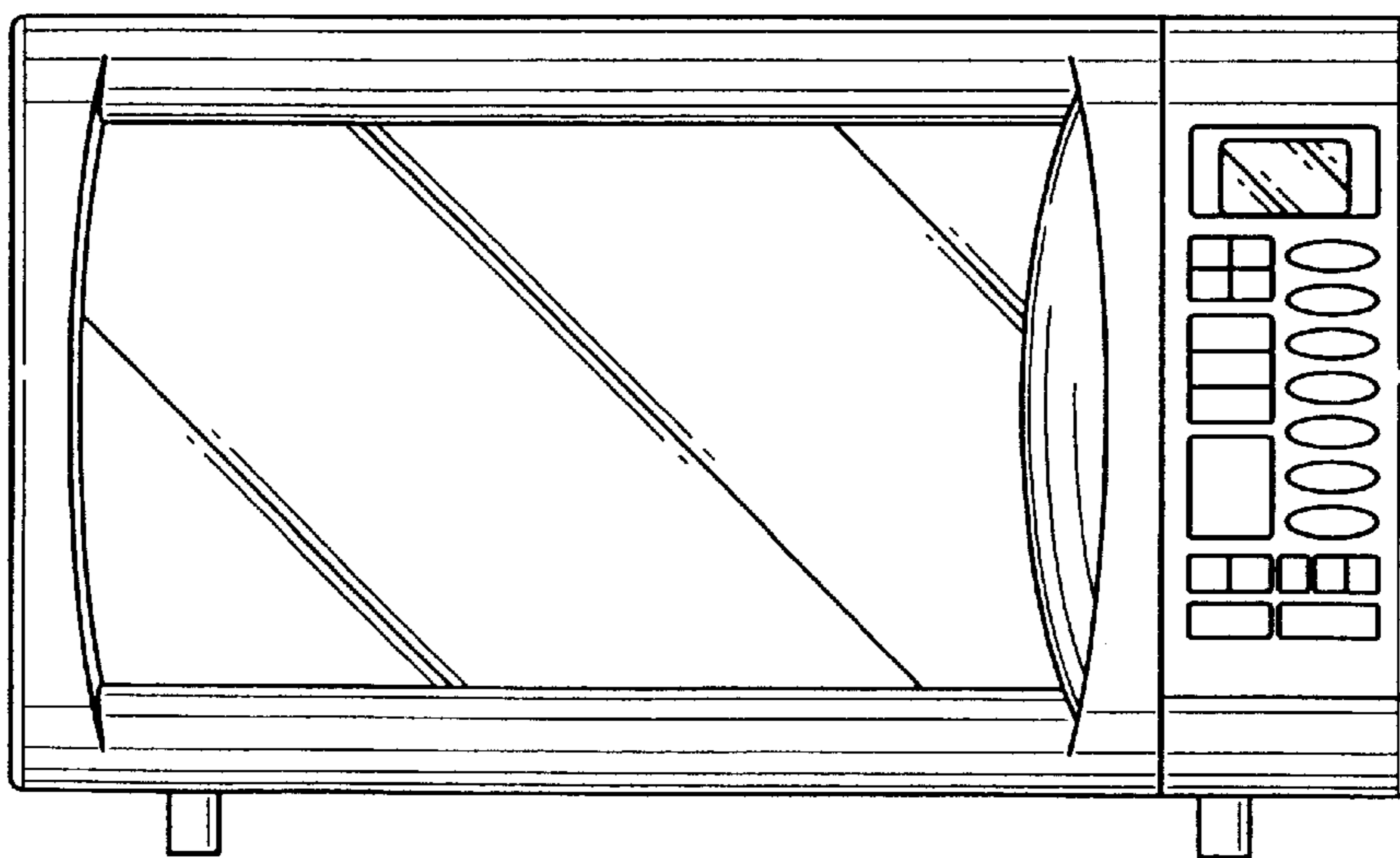

FIG. 3

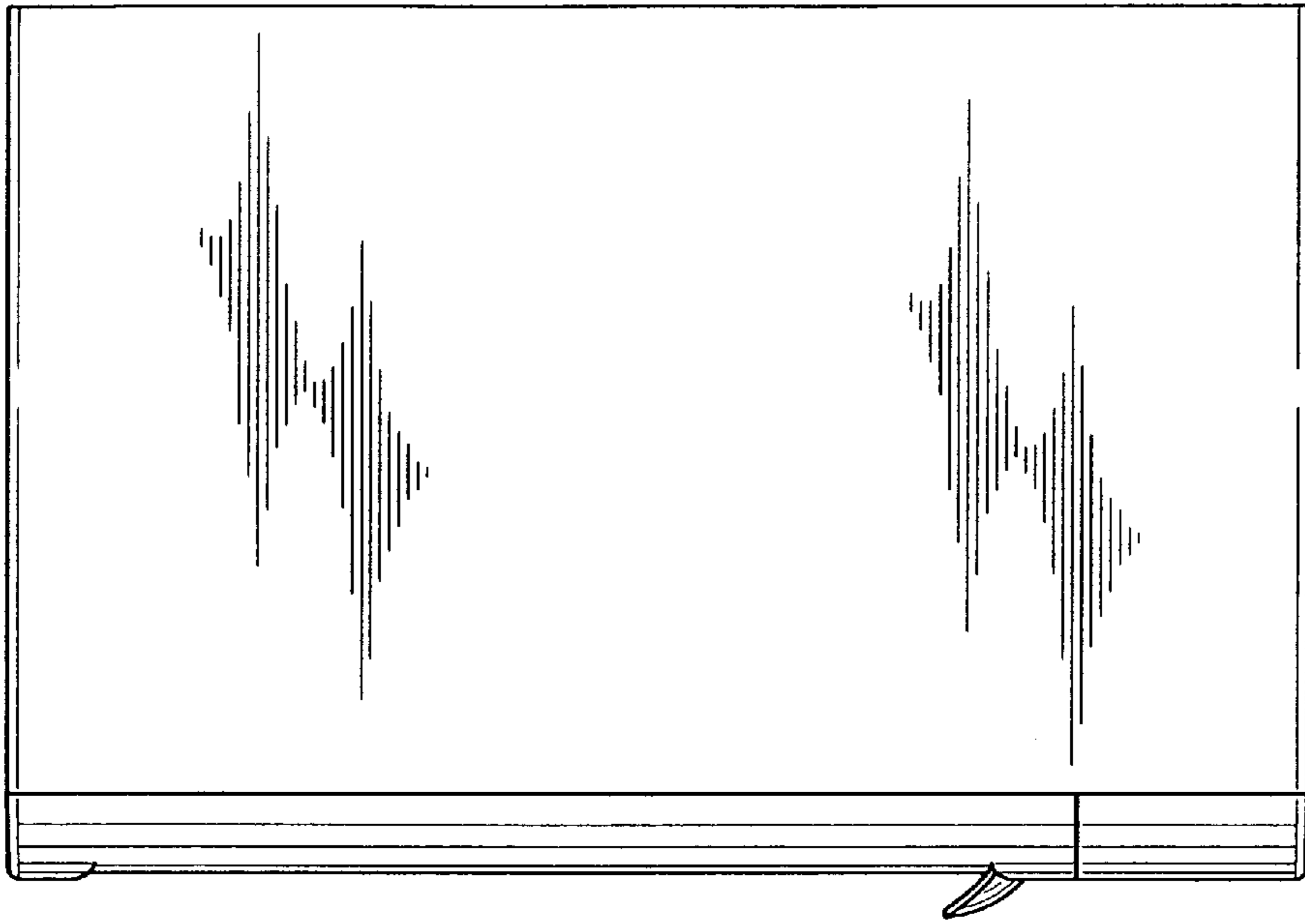

FIG. 4

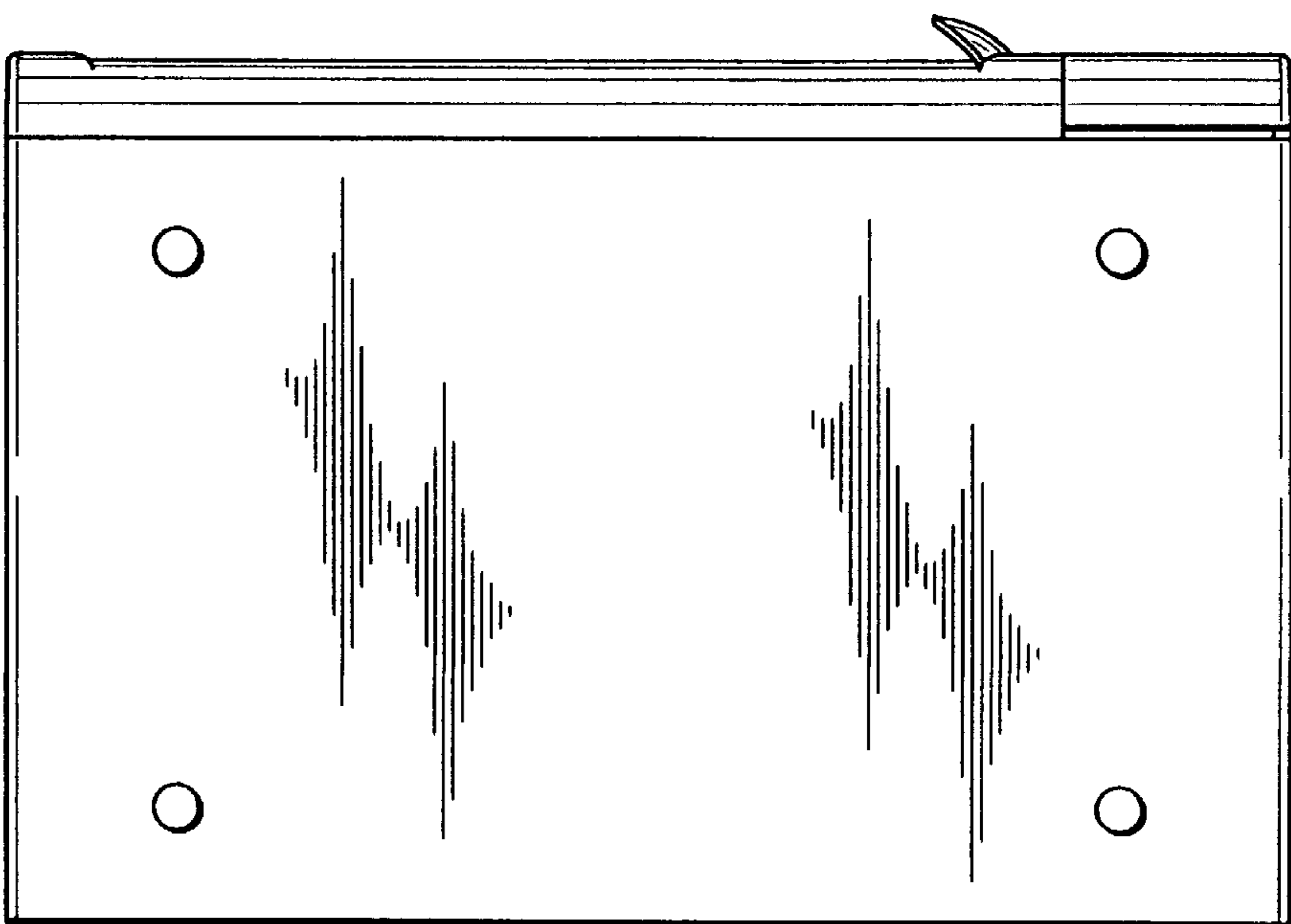

FIG. 5

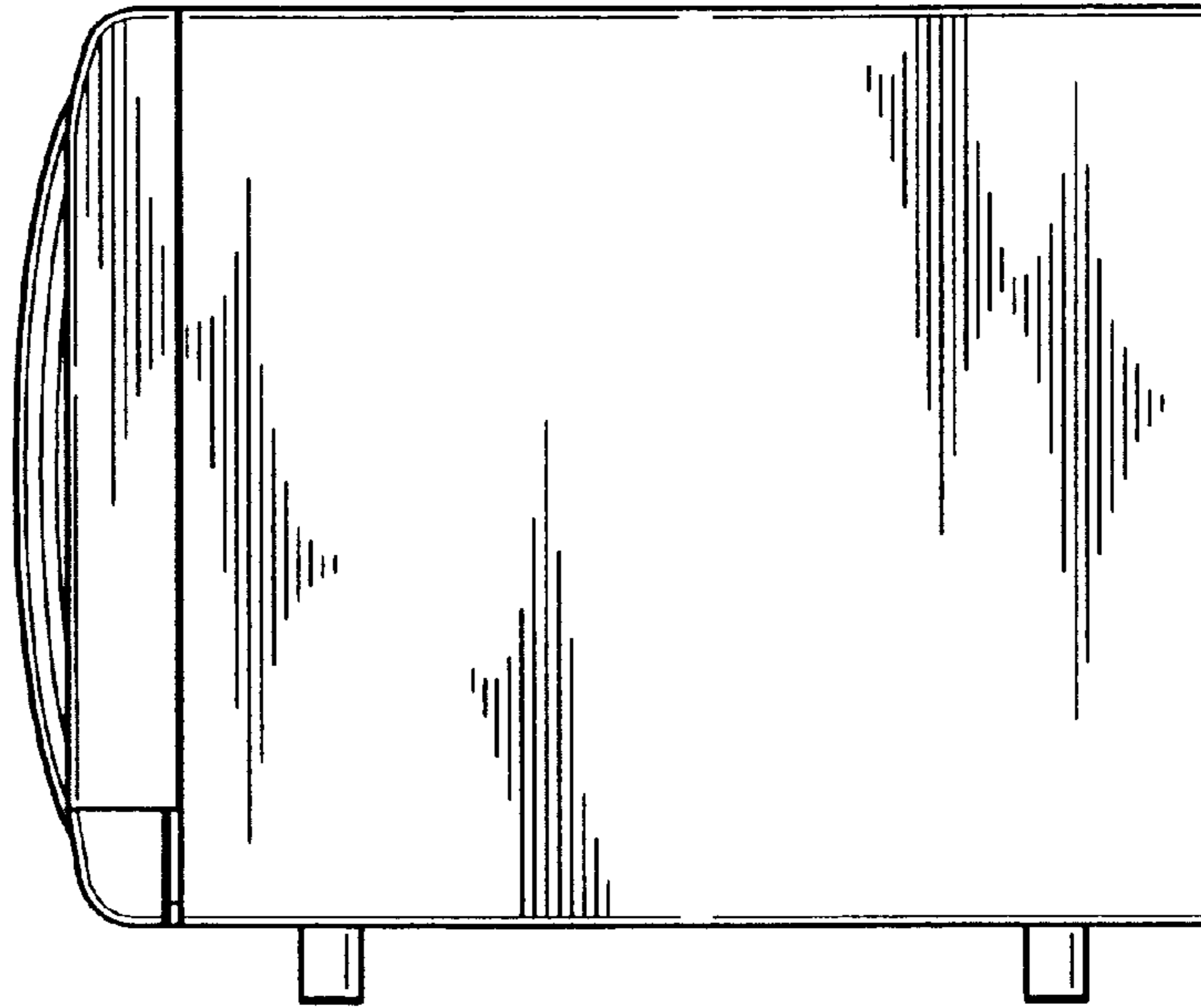

FIG. 6

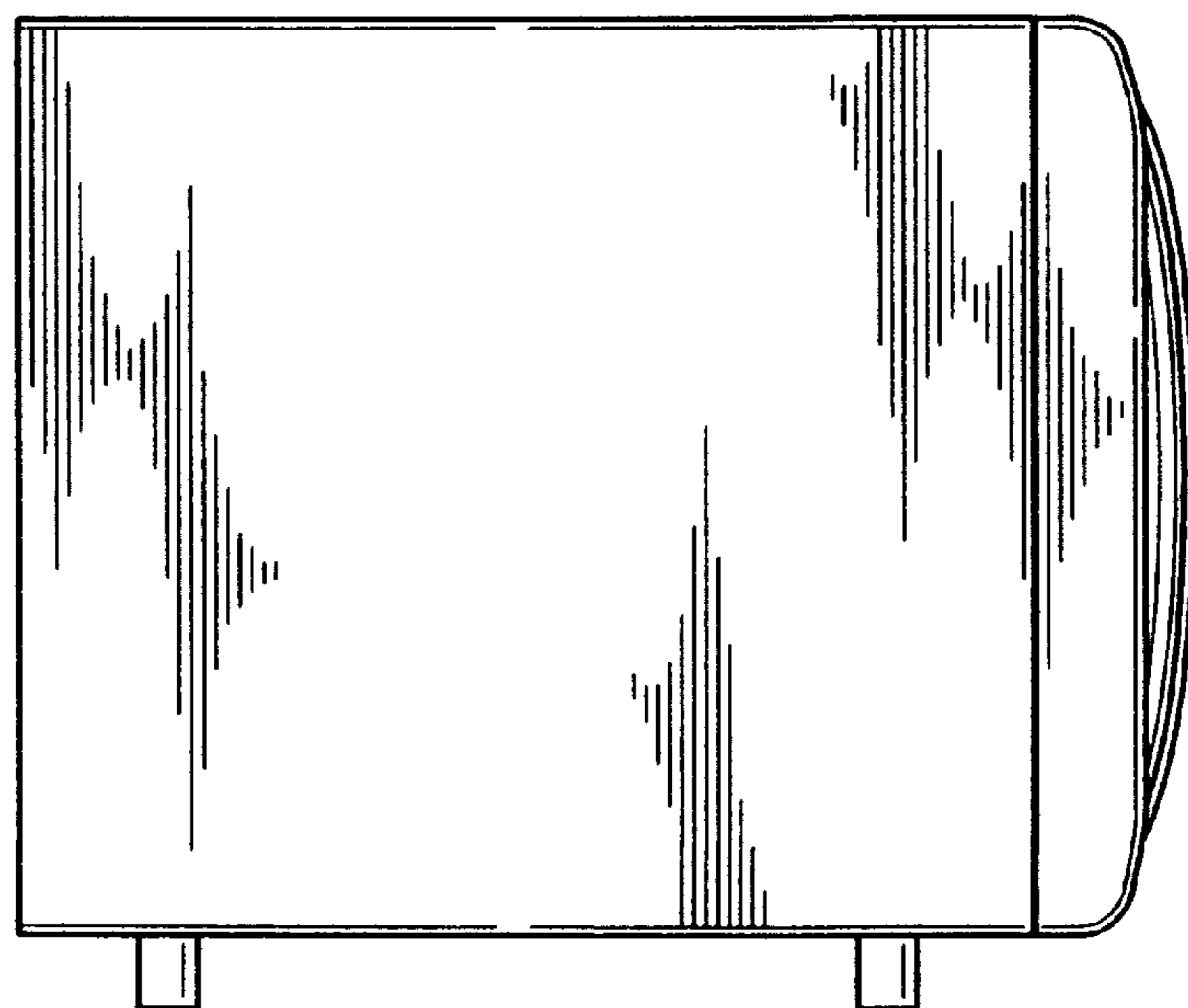

FIG. 7

