



US00D426077S

United States Patent [19] Streit

[11] **Patent Number: Des. 426,077**
[45] **Date of Patent: ** Jun. 6, 2000**

[54] **CHAIR WITH CANOPY**

[76] Inventor: **Darlene L. Streit**, 127 W. Berger St.,
Santa Fe, N.Mex. 87501

[**] Term: **14 Years**

[21] Appl. No.: **29/097,136**

[22] Filed: **Nov. 30, 1998**

[51] **LOC (7) Cl. 06-01**

[52] **U.S. Cl. D6/335**

[58] **Field of Search** D6/334, 335, 336,
D6/344, 346, 347, 362, 370, 381, 500-502;
D21/521; D25/1, 18, 56; 52/74; 297/184.1,
232, 273, 281, 440.15

[56] **References Cited**

U.S. PATENT DOCUMENTS

| | | | | |
|------------|---------|----------|-------|--------|
| D. 56,367 | 10/1920 | Leijen | | D6/335 |
| D. 82,605 | 11/1930 | Goodman | | D6/335 |
| D. 90,866 | 10/1933 | Bielecky | | D6/335 |
| D. 94,380 | 1/1935 | Debski | | D6/335 |
| D. 95,671 | 5/1935 | Frankl | | D6/335 |
| D. 146,213 | 1/1947 | Fenton | | D6/335 |

| | | | | |
|------------|---------|----------------|-------|------------|
| D. 191,411 | 5/1961 | Ahrens | | D25/18 |
| D. 230,921 | 3/1974 | Bonnell et al. | | D21/521 |
| D. 260,110 | 8/1981 | Gomes | | D6/347 |
| D. 378,171 | 2/1997 | Liu | | D6/336 |
| 445,012 | 1/1891 | Dicks | | 297/184.1 |
| 748,349 | 12/1903 | Darling | | 297/440.15 |
| 935,369 | 9/1909 | Jordalen | | 297/184.1 |

Primary Examiner—Doris V. Coles
Assistant Examiner—Mimosa De
Attorney, Agent, or Firm—John R. Lansdowne

[57] **CLAIM**

The ornamental design for a chair with canopy, as shown and described.

DESCRIPTION

FIG. 1 is a side elevational view of a chair with canopy showing my new design, it being understood that the other side is a mirror image;
FIG. 2 is a bottom plan view thereof;
FIG. 3 is a top plan view thereof;
FIG. 4 is a rear elevational view thereof; and,
FIG. 5 is a front elevational view thereof.

1 Claim, 3 Drawing Sheets

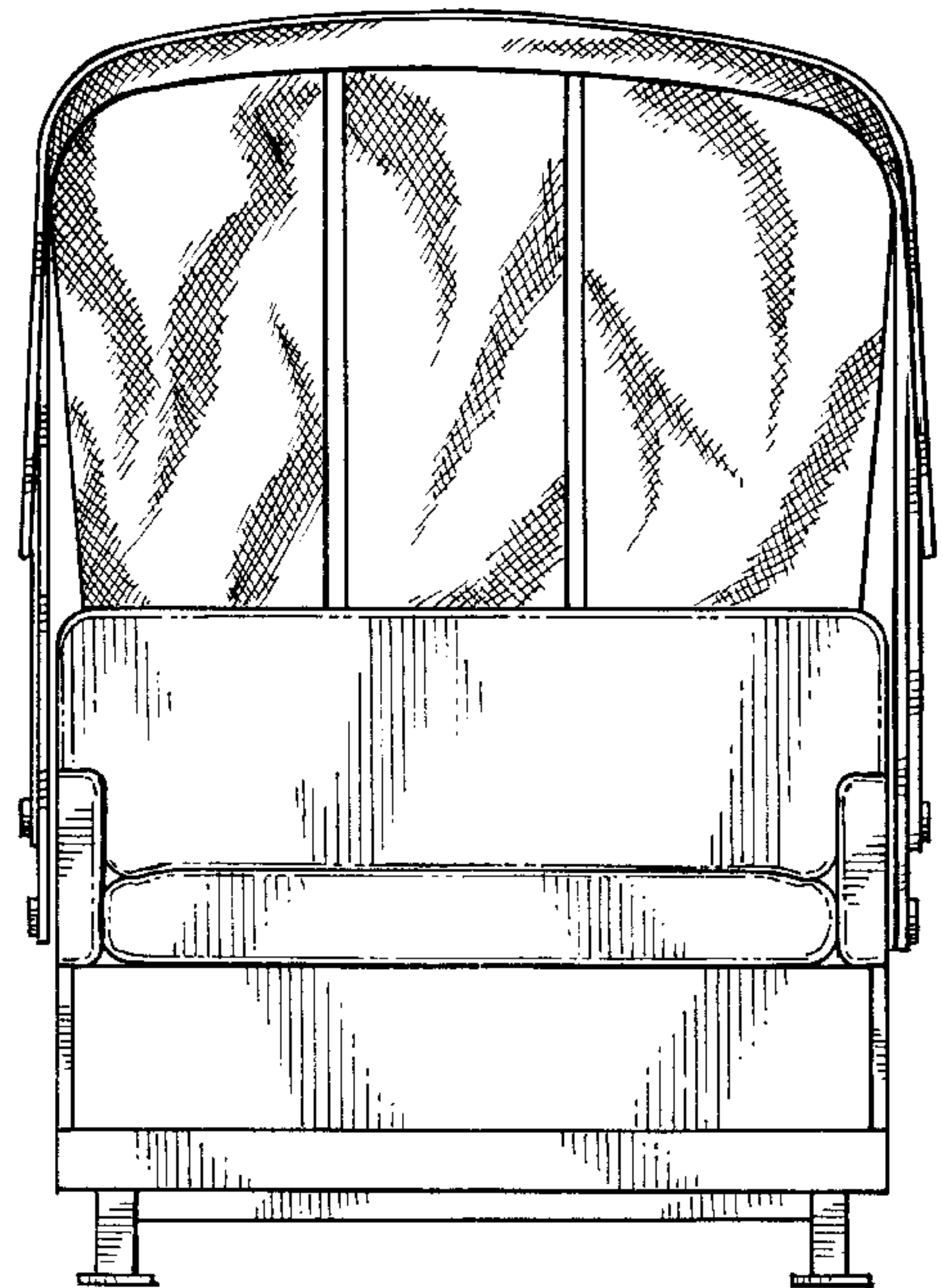
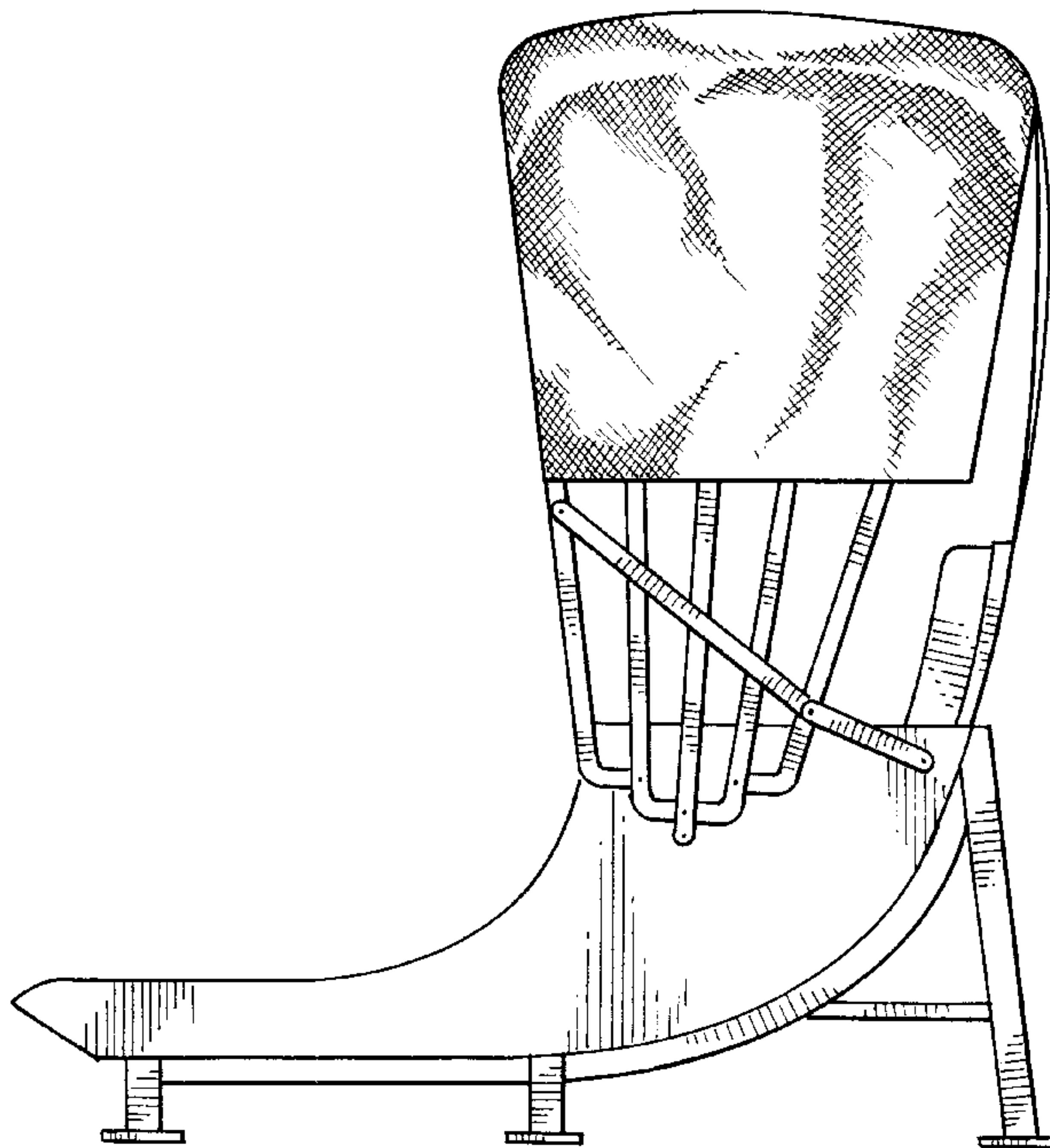

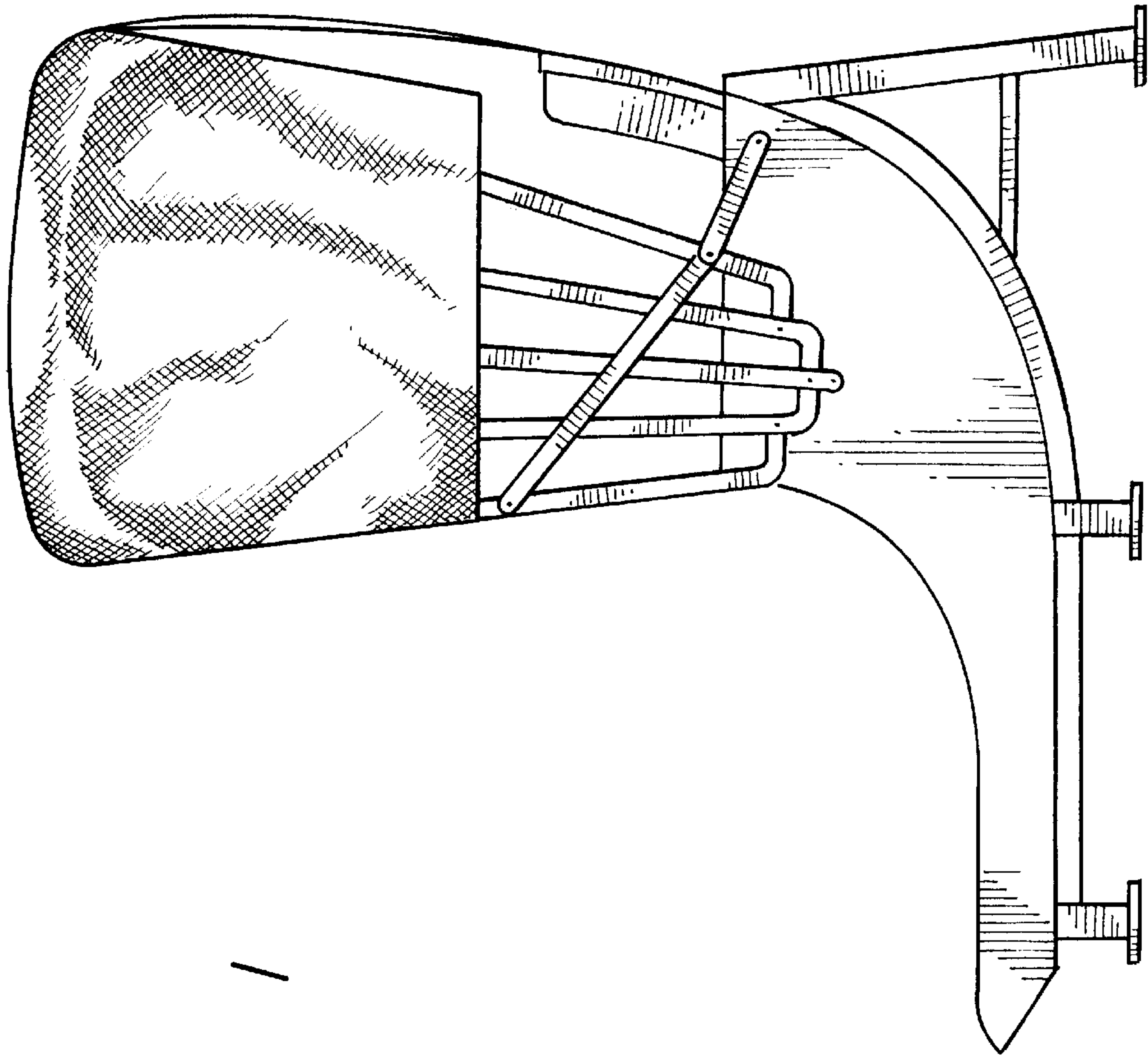

FIG. 1

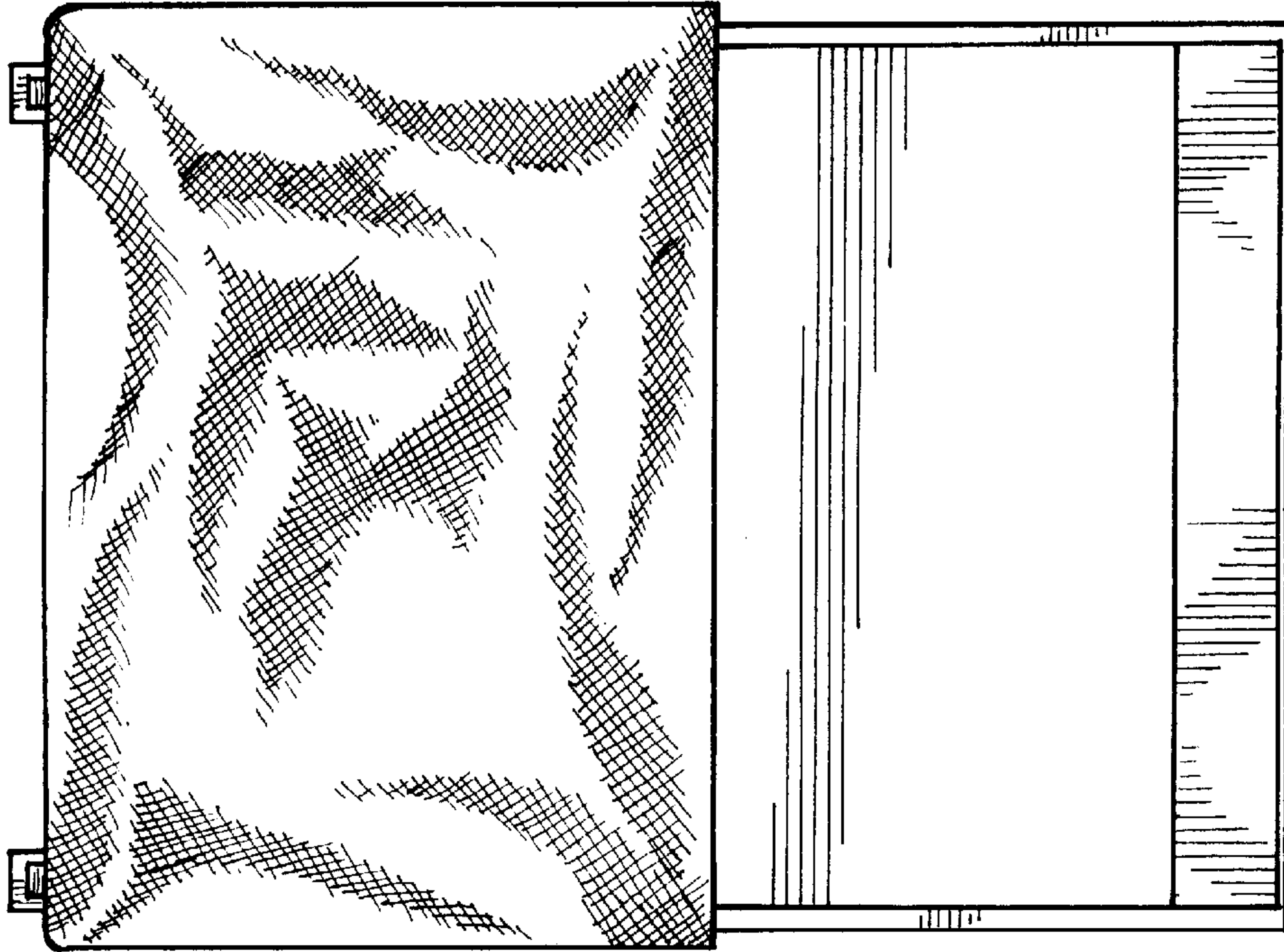

FIG. 3

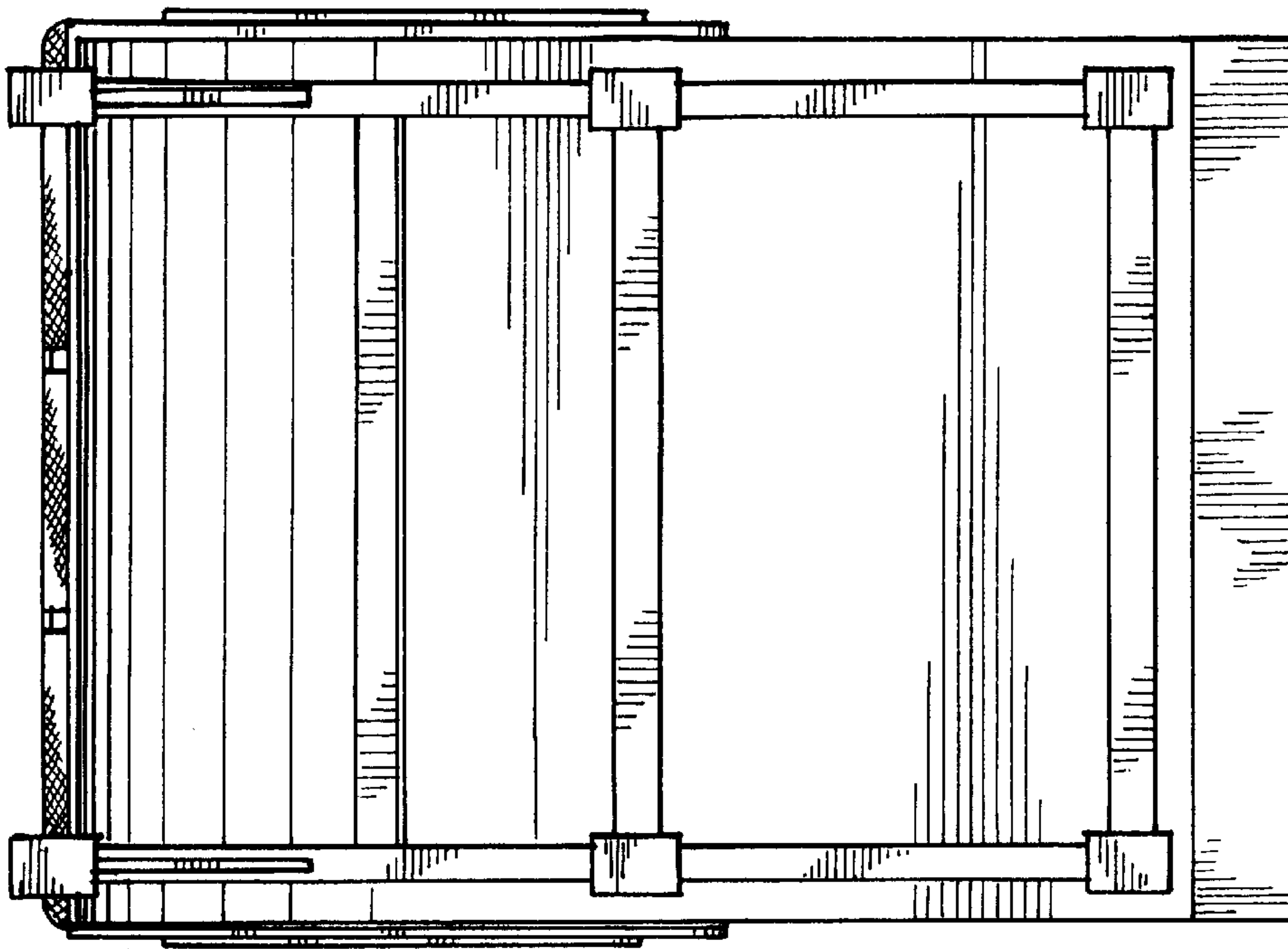

FIG. 2

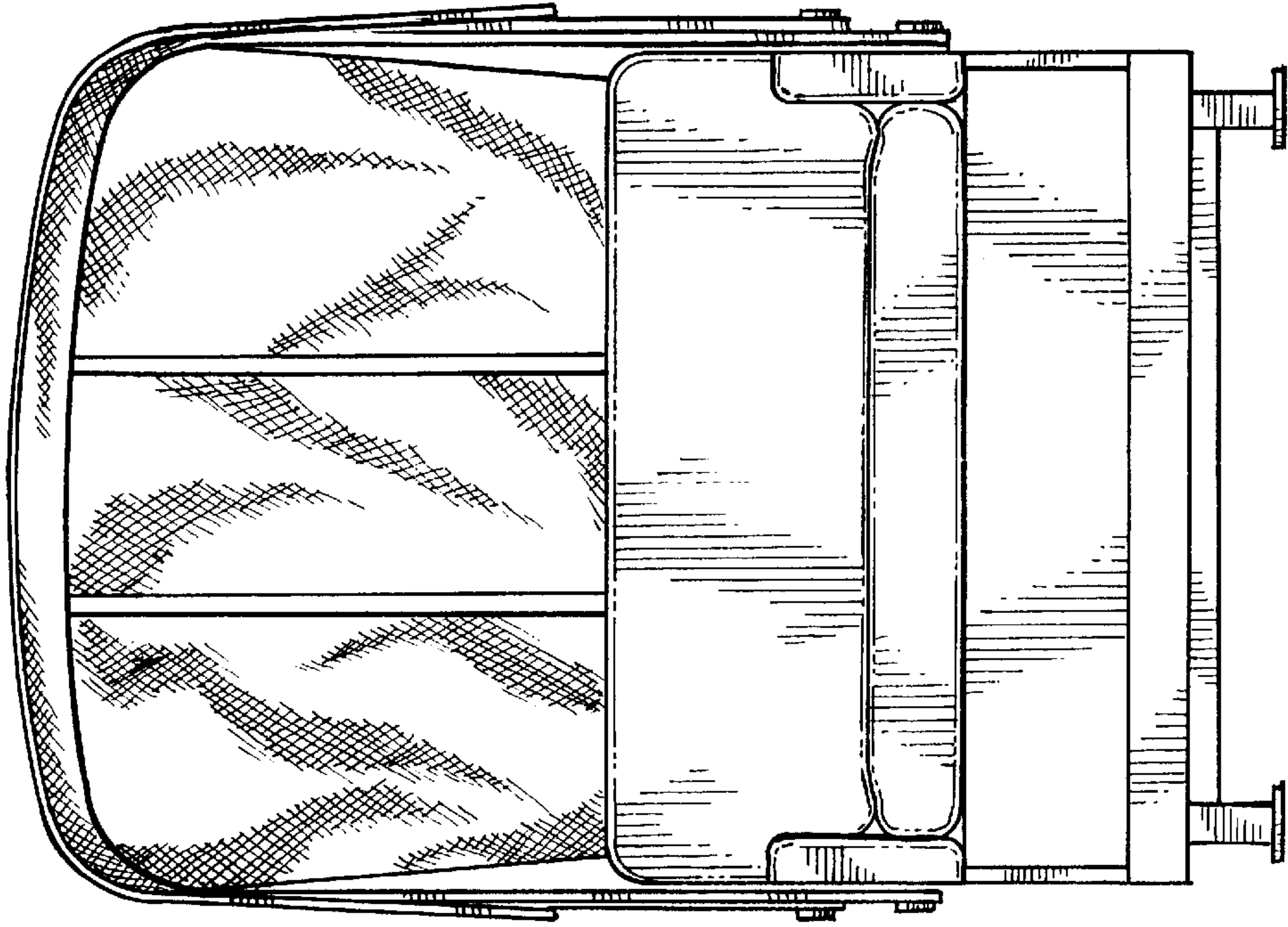

FIG. 5

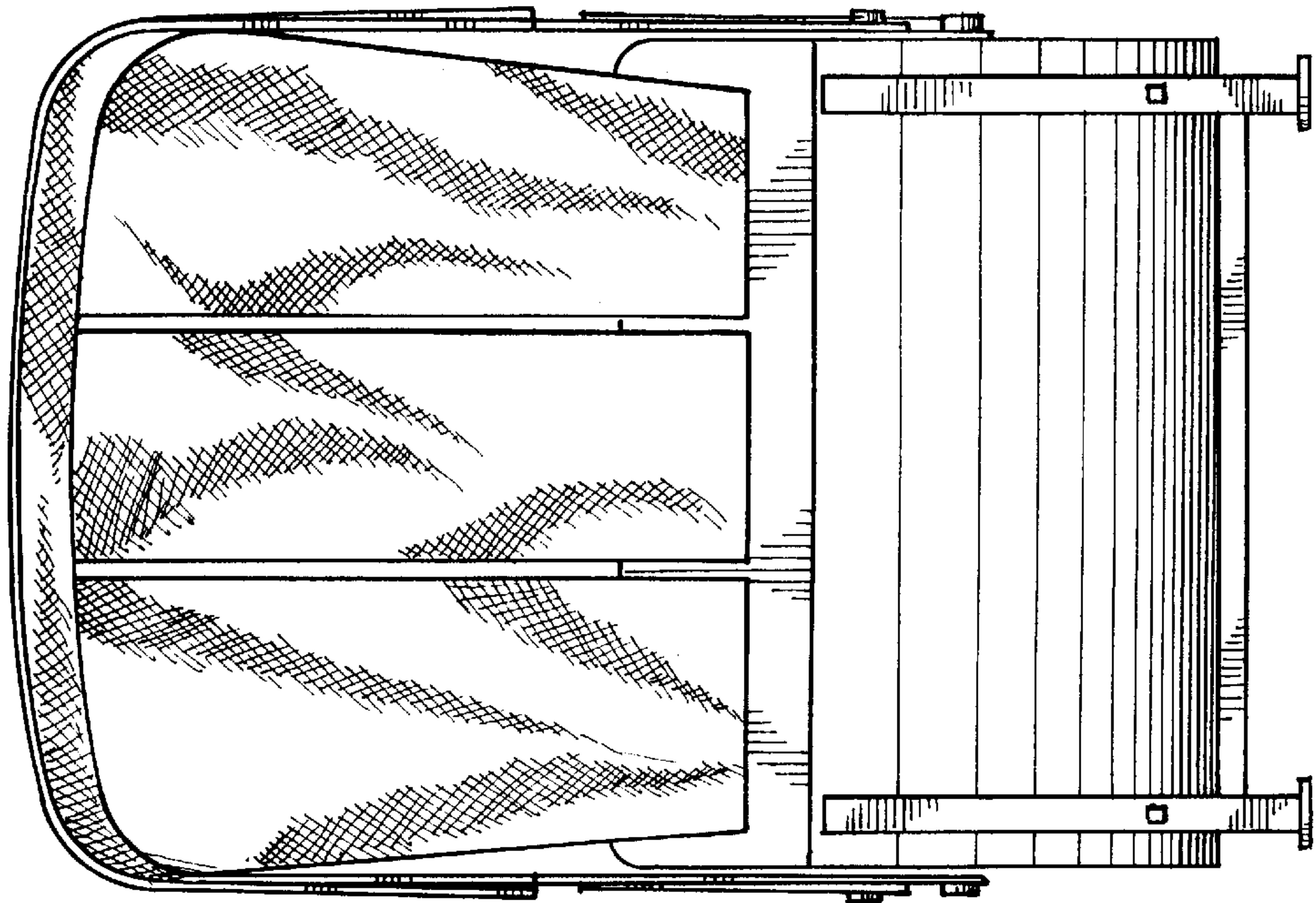

FIG. 4