



US00D426059S

# United States Patent [19]

Siler et al.

[11] Patent Number: **Des. 426,059**

[45] Date of Patent: **\*\* Jun. 6, 2000**

[54] **HANDGUN STORAGE CASE**

[76] Inventors: **Buzz Siler**, 3328 Lakeview Blvd., Lake Oswego, Oreg. 97035; **Montgomery Lee Nelson**, 15900 S. Buckner Cir., Mulino, Oreg. 97014; **Richard Lee White, II**, 48433 NW. Sylvia La., Forest Grove, Oreg. 97116

[\*\*] Term: **14 Years**

[21] Appl. No.: **29/110,790**

[22] Filed: **Sep. 15, 1999**

[51] **LOC (7) Cl.** ..... **03-01**

[52] **U.S. Cl.** ..... **D3/294; D99/28**

[58] **Field of Search** ..... **D3/273, 294; D99/28, D99/34; 109/45, 46, 50, 51, 64**

[56] **References Cited**

**U.S. PATENT DOCUMENTS**

- D. 310,304 9/1990 Carmichael ..... D99/28
- D. 350,002 8/1994 Viola ..... D99/28

- D. 368,249 3/1996 Ferrer ..... D99/28
- D. 375,608 11/1996 Berry ..... D99/28
- D. 410,130 5/1999 Kerr et al. .... D99/28
- 4,542,848 9/1985 Peters ..... 109/45

*Primary Examiner*—Philip S. Hyder

[57] **CLAIM**

The ornamental design for a handgun storage case, as shown and described.

**DESCRIPTION**

FIG. 1 is a front perspective view with open door;  
 FIG. 2 is a front perspective view with closed door view;  
 FIG. 3 is a top view;  
 FIG. 4 is a back view;  
 FIG. 5 is a left side view. The right side view is a mirror image;  
 FIG. 6 is a front view; and,  
 FIG. 7 is a bottom view.  
 FIGS. 3 through 7 show the hand gun storage with the door closed.

**1 Claim, 2 Drawing Sheets**

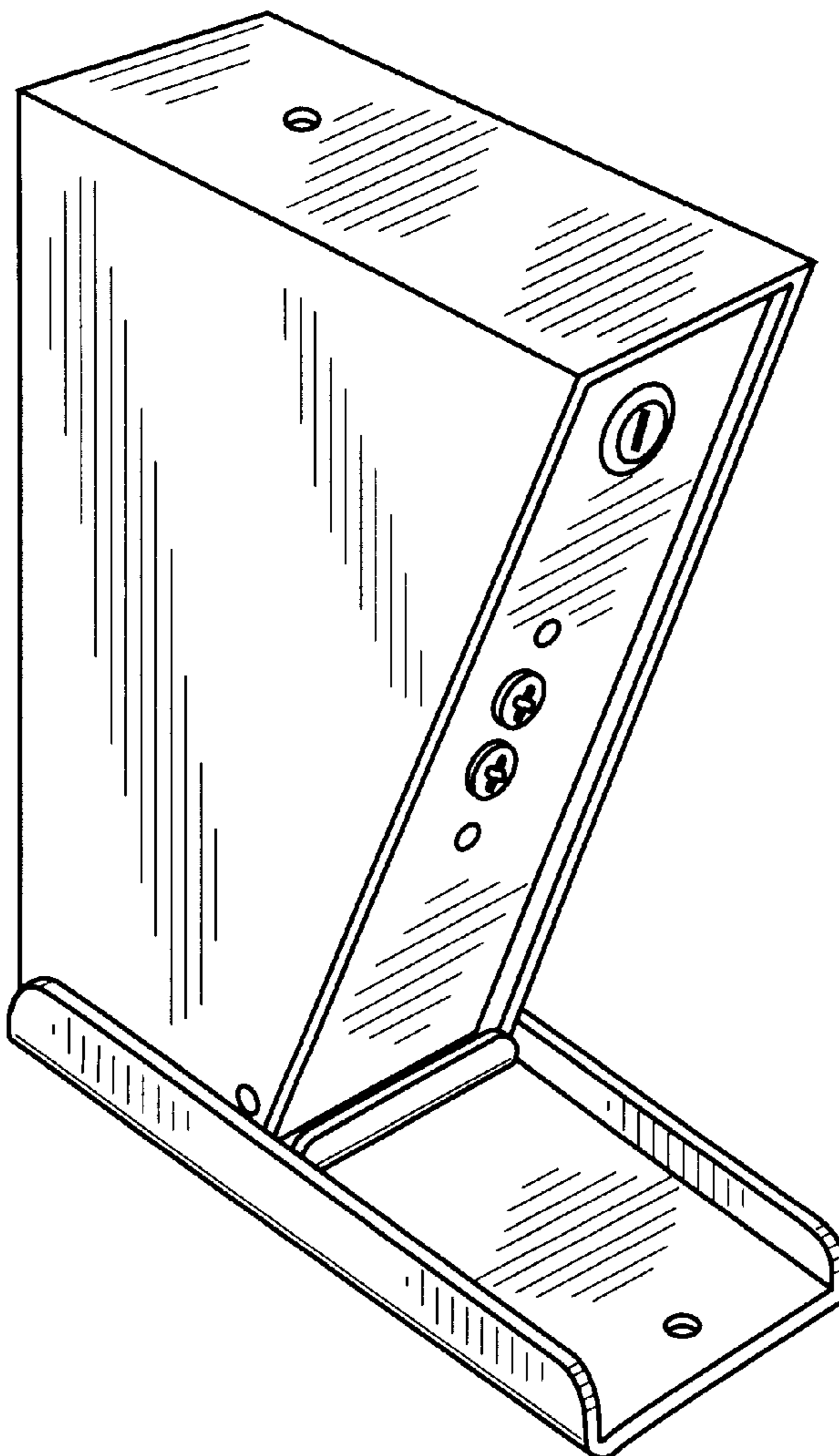

FIG. 1

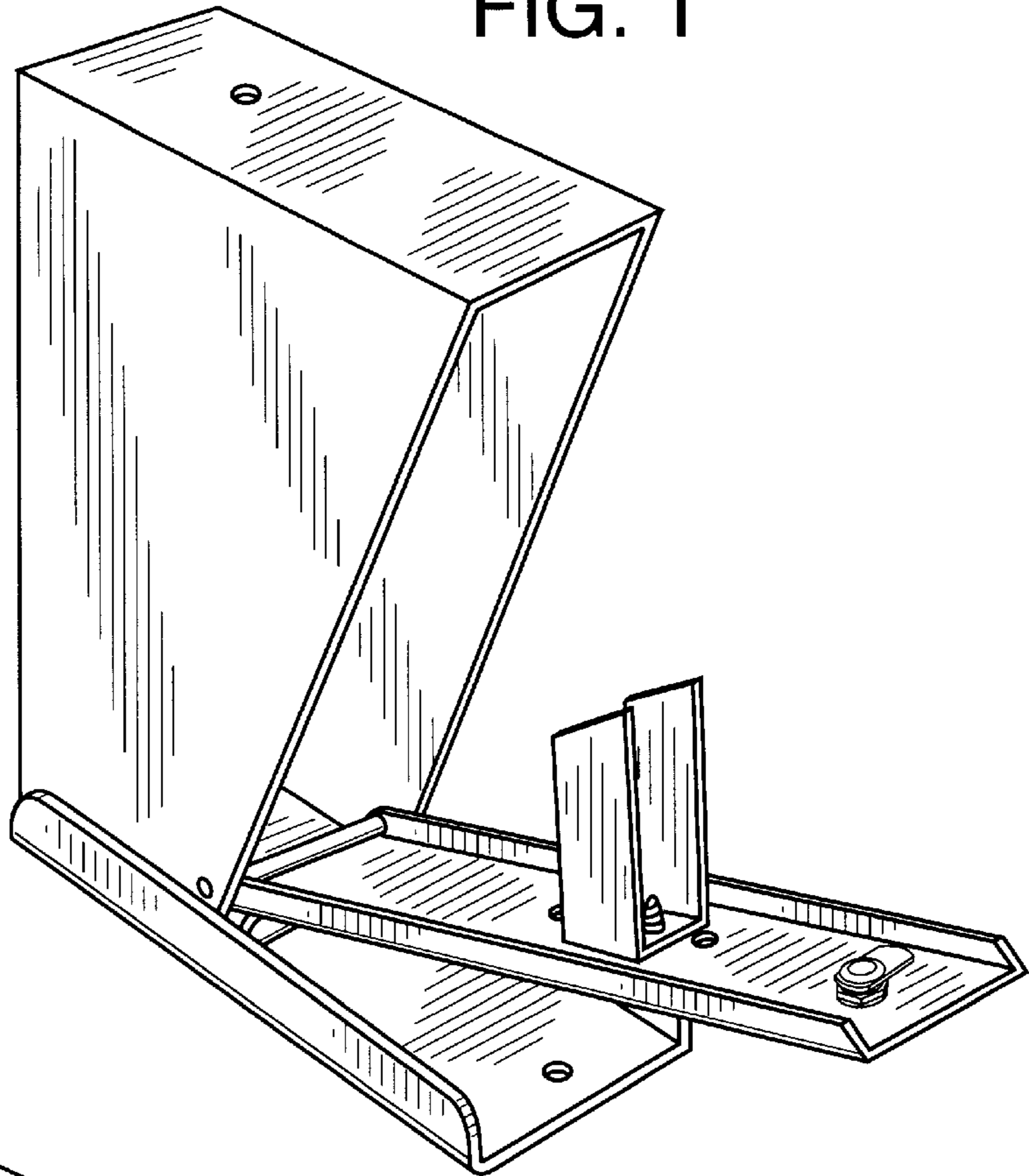

FIG. 2

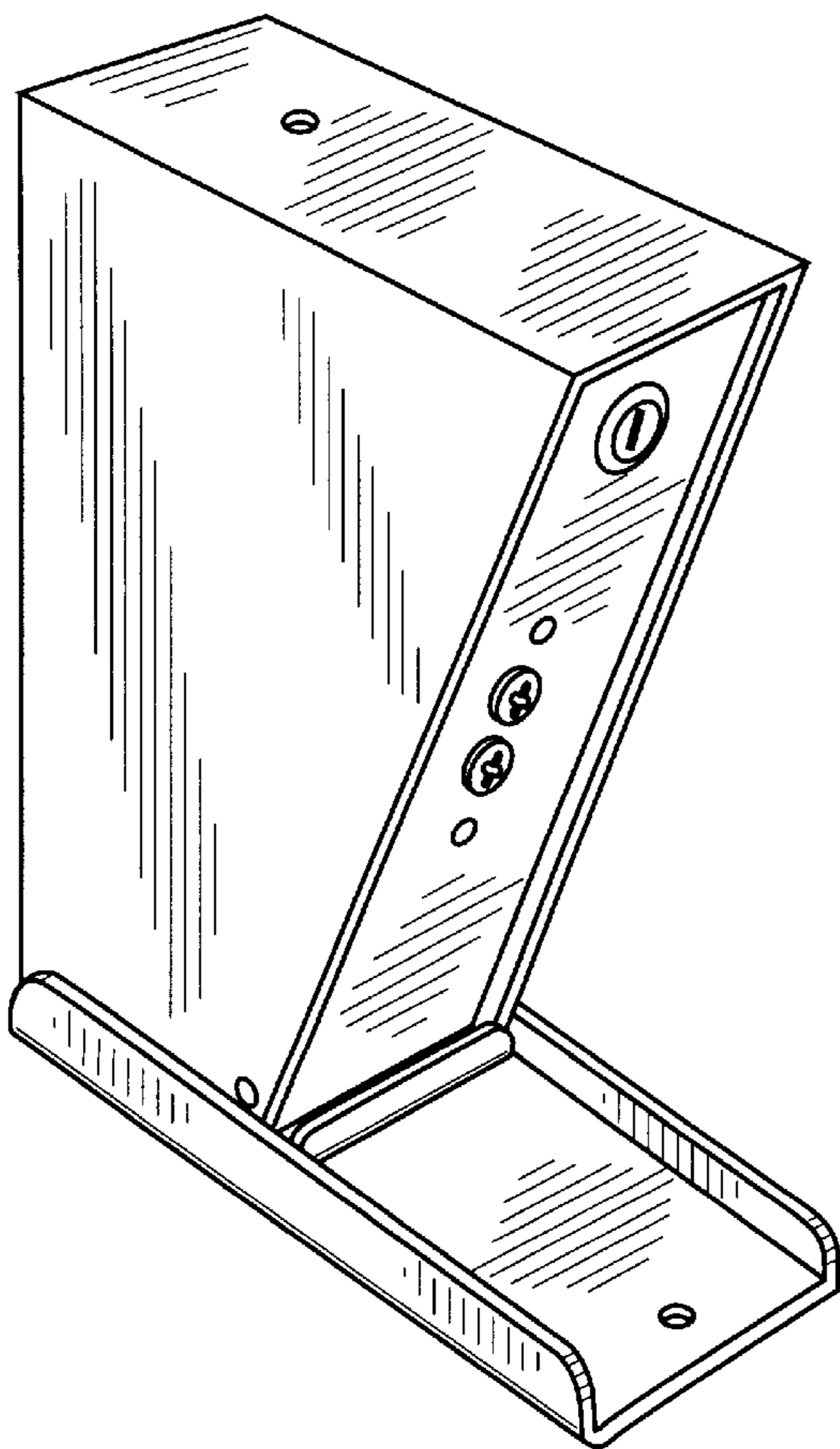

FIG. 3

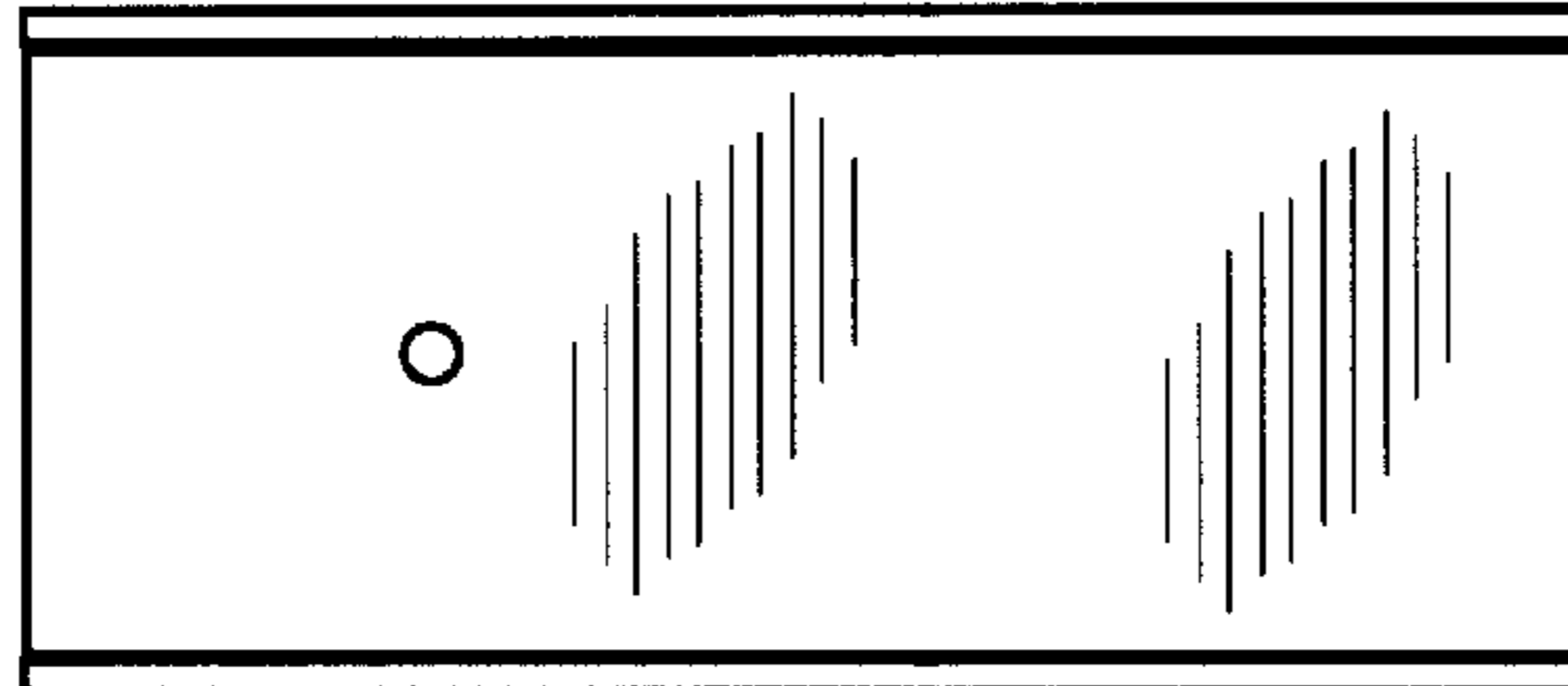

FIG. 4

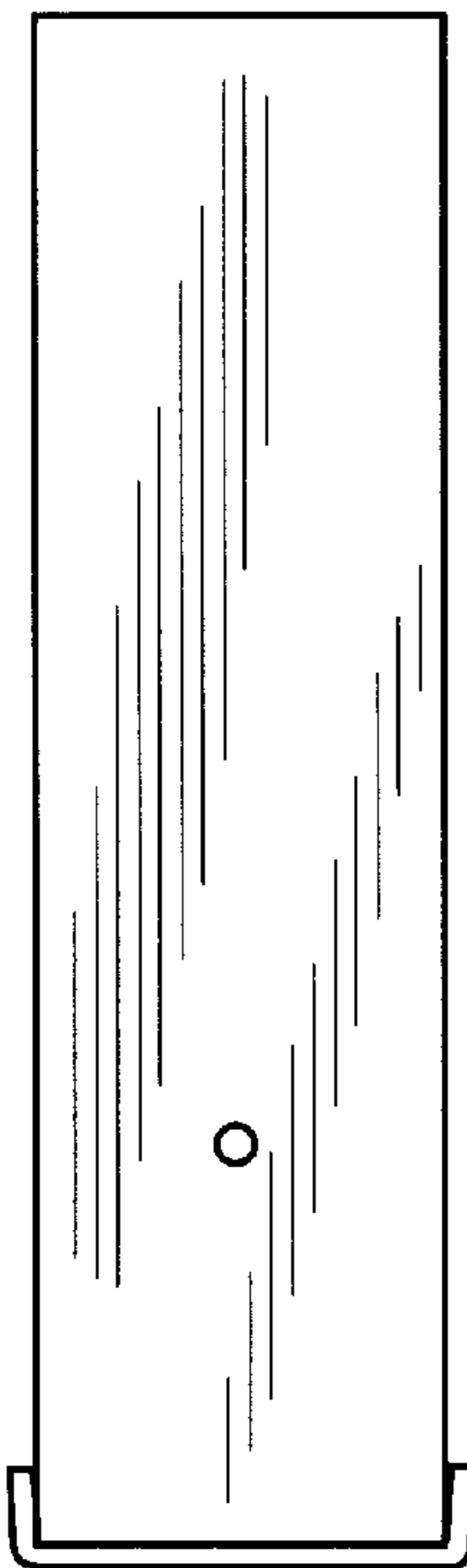

FIG. 6

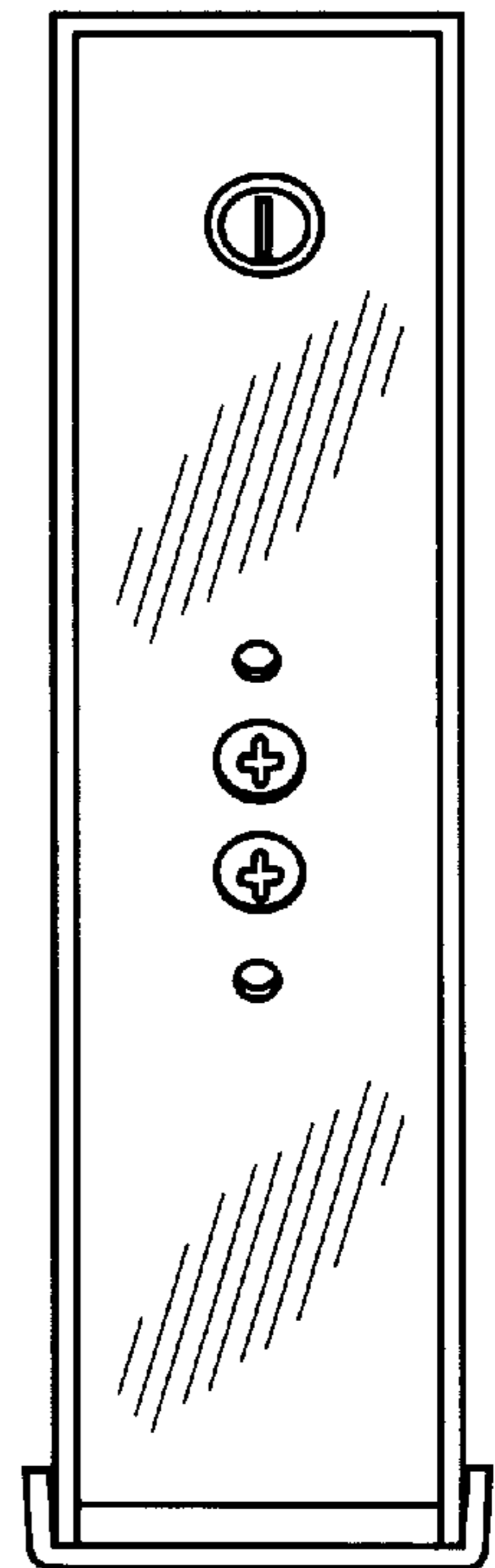

FIG. 5

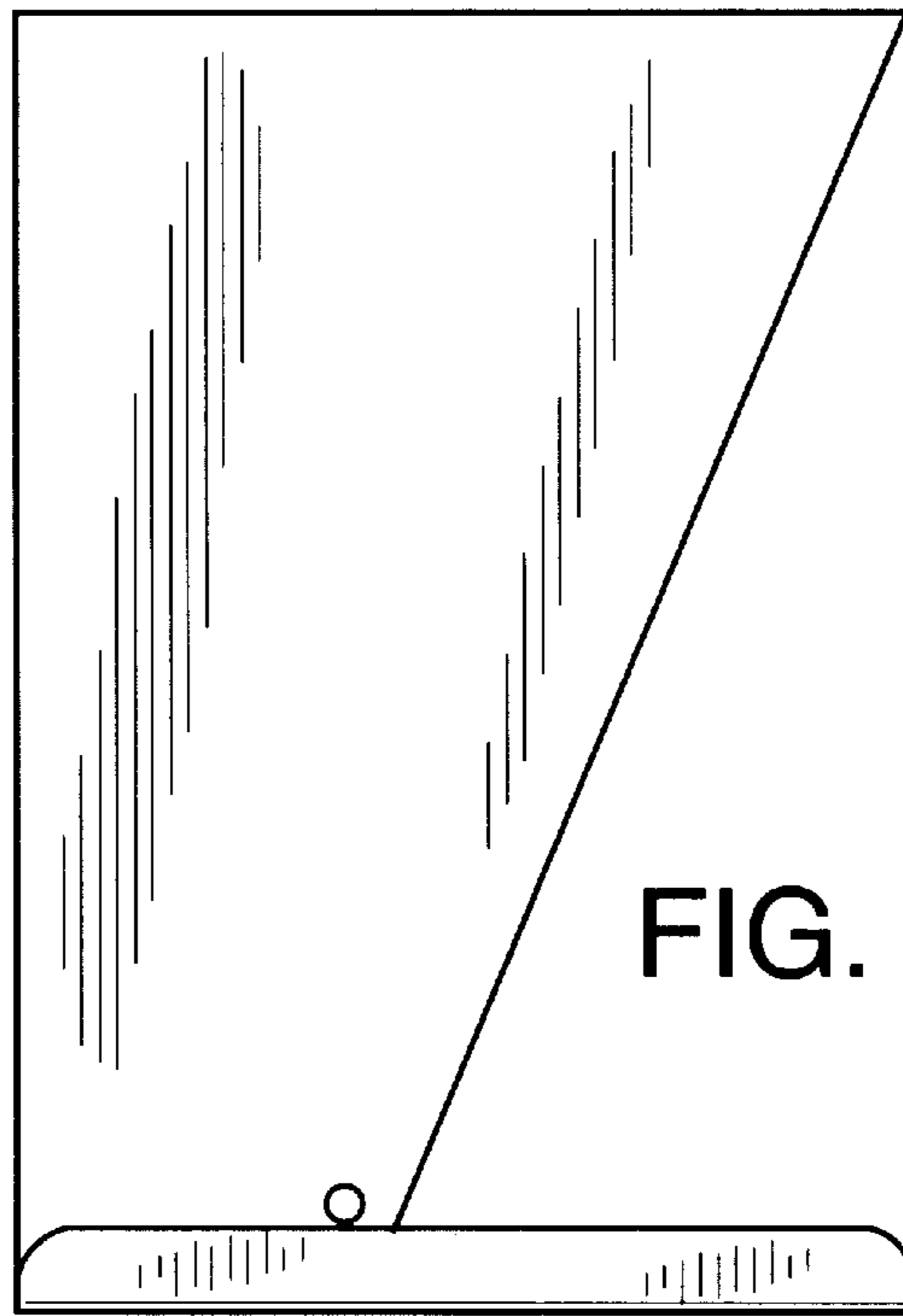

FIG. 7

