



US00D425994S

**United States Patent** [19]  
**Hakim**

[11] **Patent Number: Des. 425,994**

[45] **Date of Patent: \*\* May 30, 2000**

[54] **BABY BOTTLES**

[76] Inventor: **Nouri E. Hakim**, c/o 2813 Desiard St.,  
Monroe, La. 71201

[\*\*] Term: **14 Years**

[21] Appl. No.: **29/088,360**

[22] Filed: **May 21, 1998**

[51] **LOC (7) Cl.** ..... **07-01**

[52] **U.S. Cl.** ..... **D24/197**

[58] **Field of Search** ..... D24/197; 215/11.1,  
215/11.2, 11.3, 11.4, 11.5, 11.6; D7/510,  
511, 533, 534, 535, 536

[56] **References Cited**

**U.S. PATENT DOCUMENTS**

D. 216,730	3/1970	Carslaw	.....	D7/510
D. 233,972	12/1974	Juhlin	.....	D7/511
D. 279,752	7/1985	Jagger	.....	D7/510
D. 309,948	8/1990	Chambers	.....	D24/197
D. 315,212	3/1991	Oknuki	.....	D24/197
D. 315,213	3/1991	Ohnuki	.....	D24/197
D. 341,892	11/1993	Yagi	.....	D24/197
D. 368,529	4/1996	Allegre	.....	D24/197
D. 370,262	5/1996	Allegre	.....	D24/197
2,792,696	5/1957	Stayart	.....	215/11.1
3,990,596	11/1976	Hoftman	.....	215/11.1
4,801,027	1/1989	Hunter	.....	215/11.1
4,917,252	4/1990	Chambers et al.	.....	215/11.1

**FOREIGN PATENT DOCUMENTS**

935816 11/1993 France .

*Primary Examiner*—Stella Reid

*Attorney, Agent, or Firm*—Levisohn, Lerner, Berger &  
Langsam

[57] **CLAIM**

I claim the ornamental design for a baby bottle, as shown  
and described.

**DESCRIPTION**

FIG. 1 is a perspective view of the first embodiment of an

invention comprising a baby bottle;

FIG. 2 is a top plan view of the baby bottle invention shown  
in FIG. 1;

FIG. 3 is a front view of the baby bottle invention shown in  
FIGS. 1–2, with the rear view being a mirror image thereof;

FIG. 4 is a right side view of the baby bottle invention shown  
in FIGS. 1–3 with the left side view being a mirror image  
thereof;

FIG. 5 is a bottom plan view of the baby bottle invention  
shown in FIGS. 1–4.

FIG. 6 is a perspective view of a second embodiment of a  
baby bottle invention;

FIG. 7 is a top plan view of the second baby bottle invention  
shown in FIG. 6;

FIG. 8 is a front view of the second baby bottle invention  
shown in FIGS. 6–7, with the rear view being a mirror image  
thereof;

FIG. 9 is a right side view of the second baby bottle  
invention shown in FIGS. 6–8, with the left side view being  
a mirror image thereof;

FIG. 10 is a bottom plan view of the second baby bottle  
invention shown in FIGS. 6–9.

FIG. 11 is a perspective view of the third embodiment of a  
baby bottle invention;

FIG. 12 is a top plan view of the third baby bottle invention  
shown in FIG. 11;

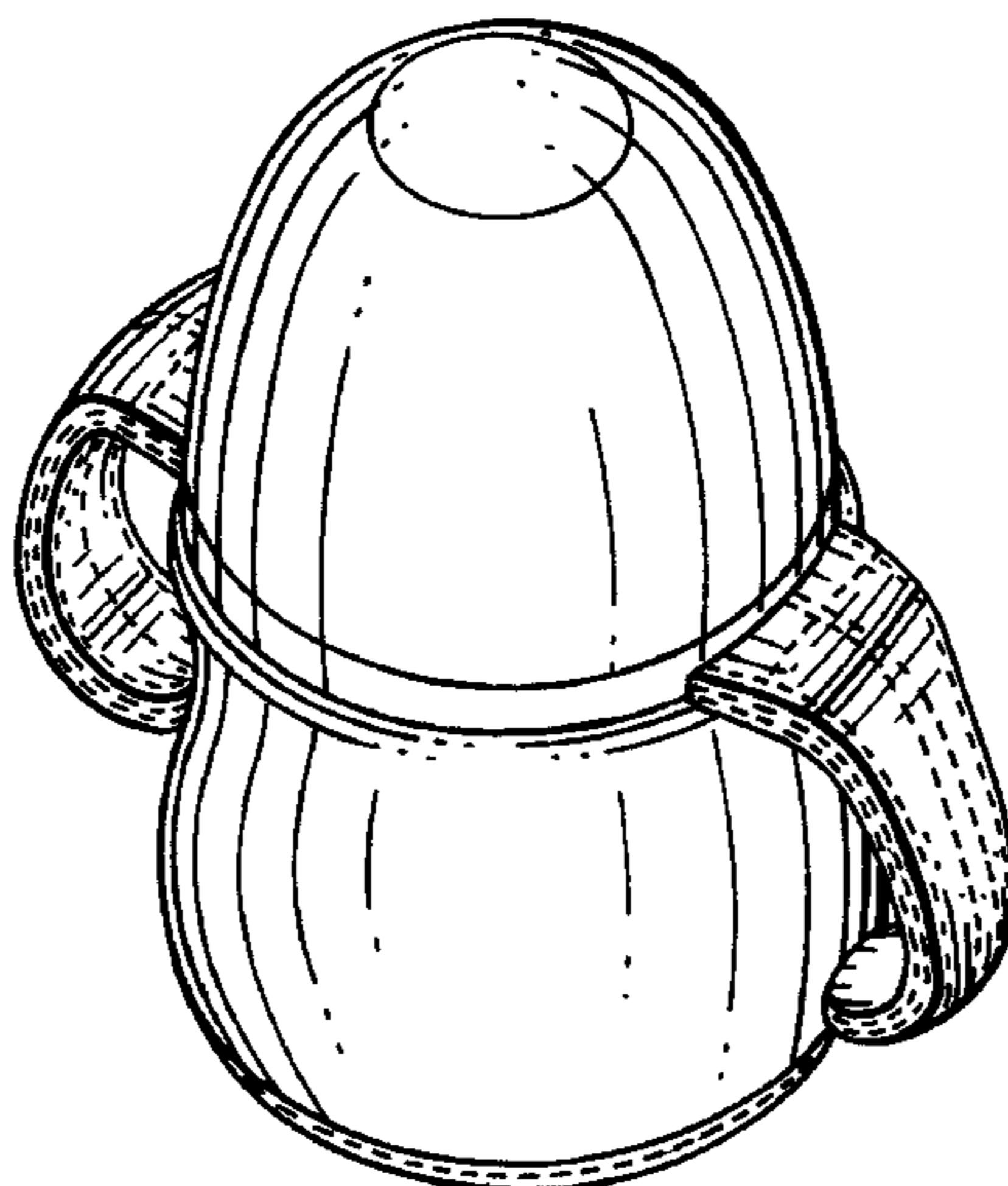
FIG. 13 is a front view of the third baby bottle invention  
shown in FIGS. 11–12, with the rear view being a mirror  
image thereof;

FIG. 14 is a right side view of the third baby bottle  
invention shown in FIGS. 11–13, with the left side view being  
a mirror image thereof; and,

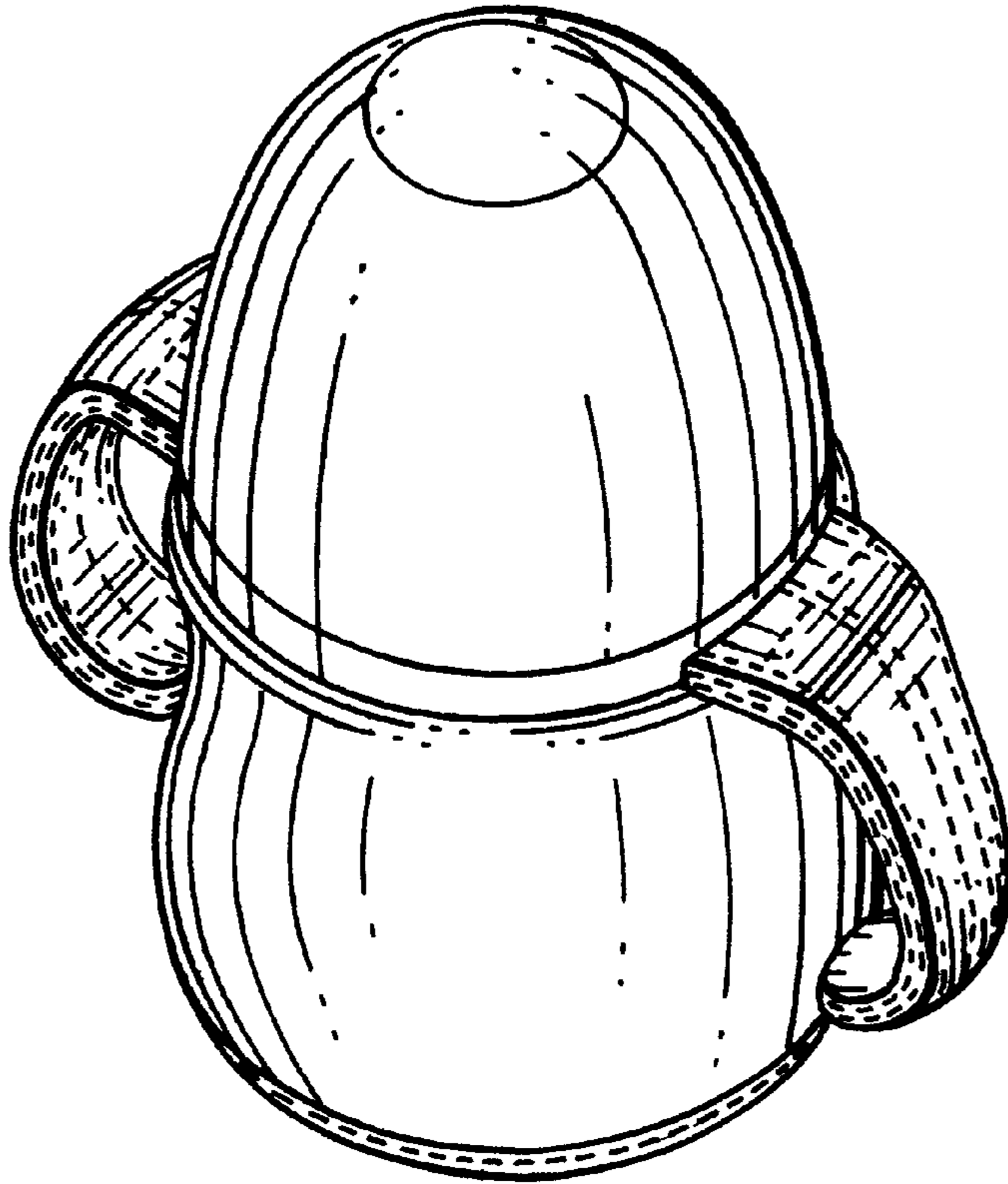
FIG. 15 is a bottom plan view of the third baby bottle  
invention shown in FIGS. 11–14.

The broken line showing in FIGS. 1–5 are for illustrative  
purposes only and form no part of the claimed design.

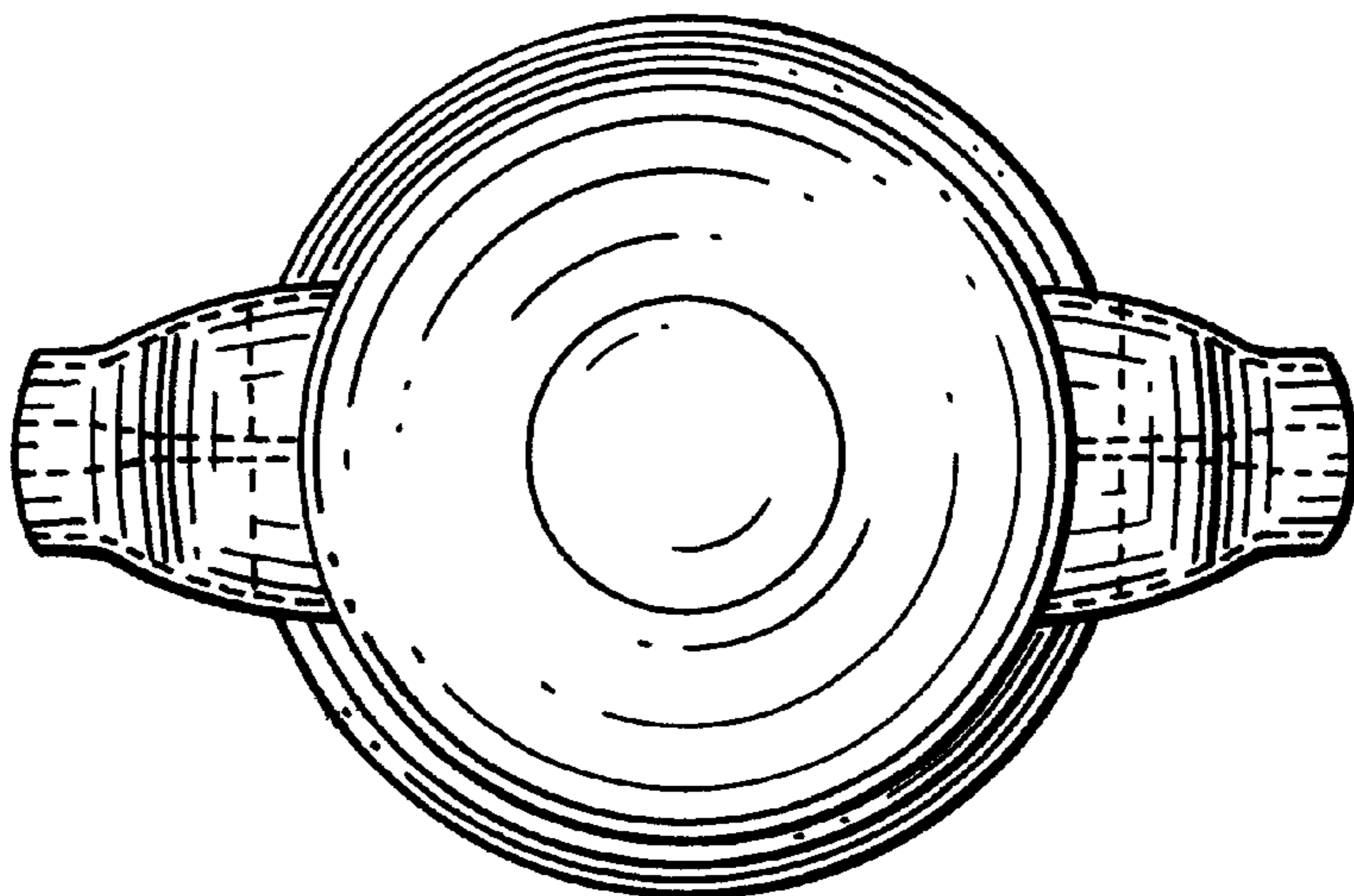
**1 Claim, 6 Drawing Sheets**

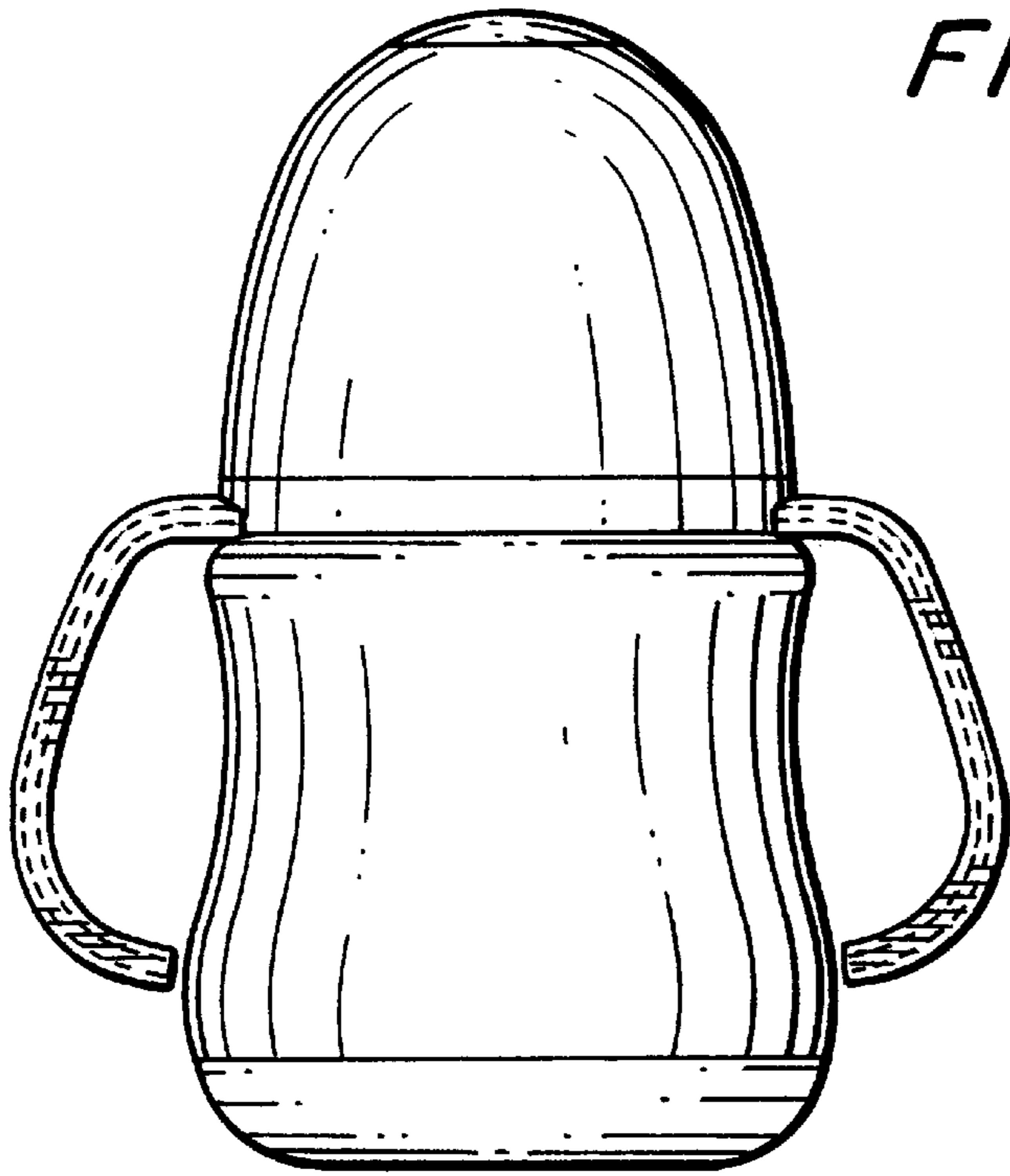


*FIG. 1*

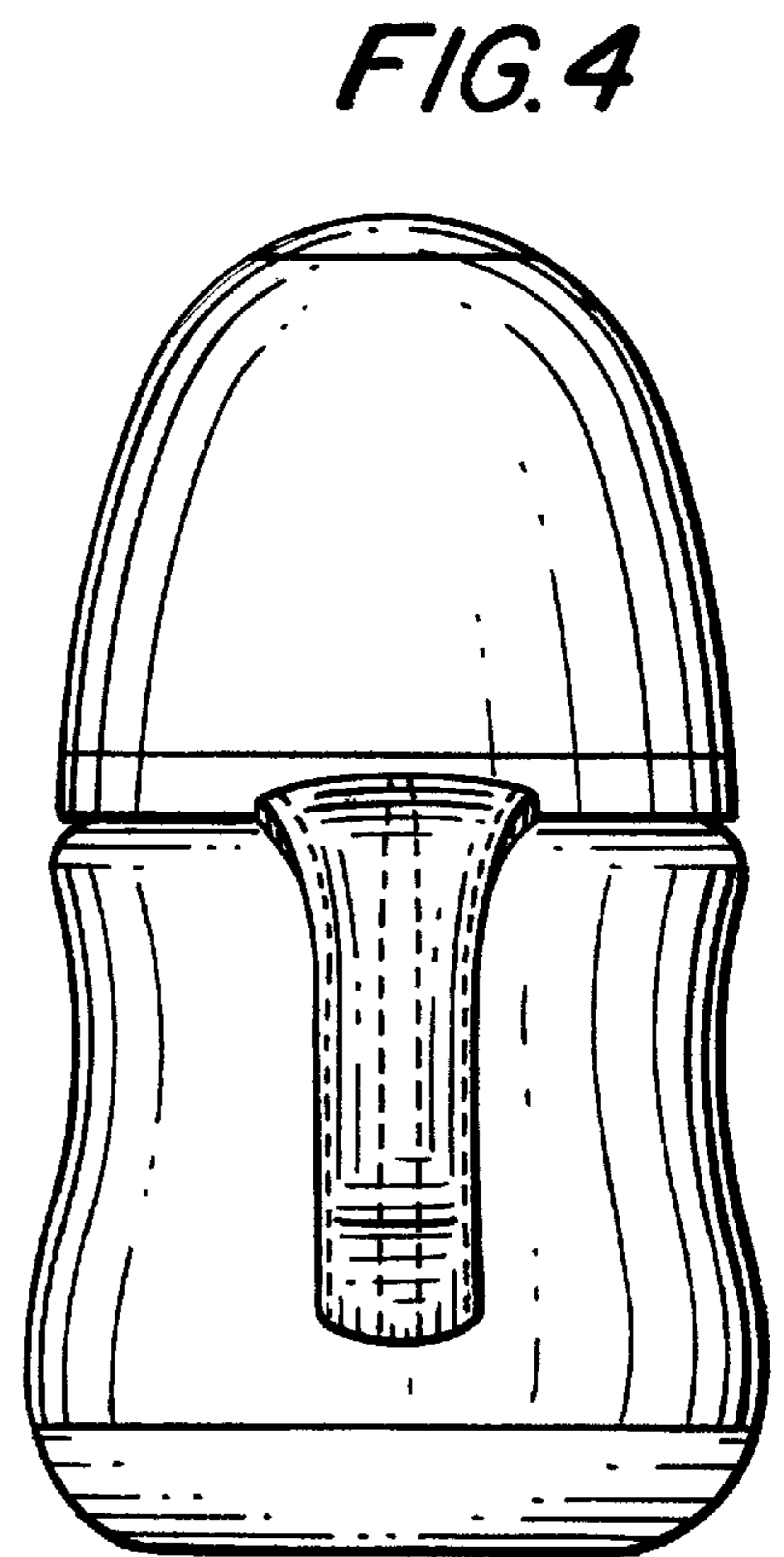


*FIG. 2*

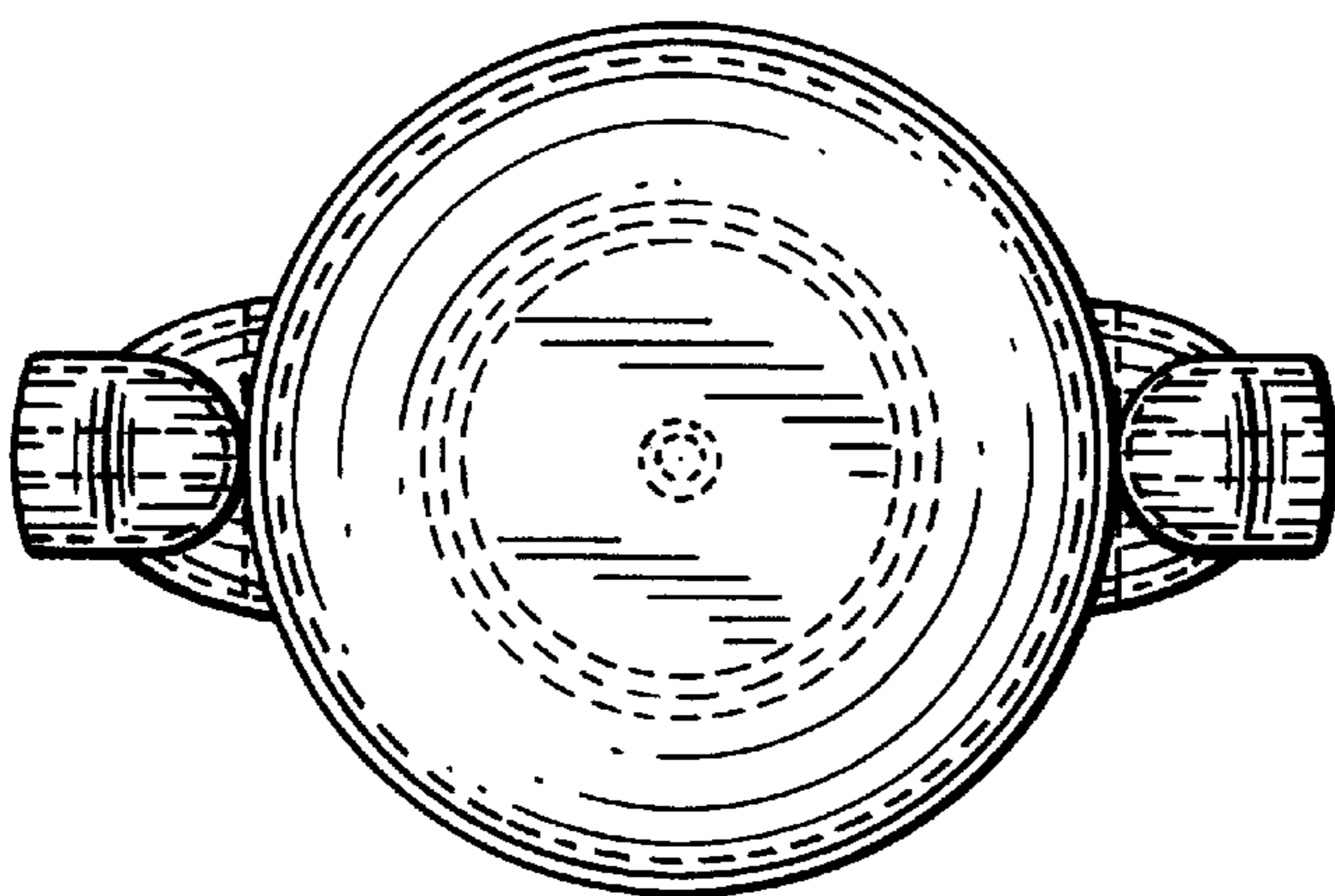




*FIG. 3*



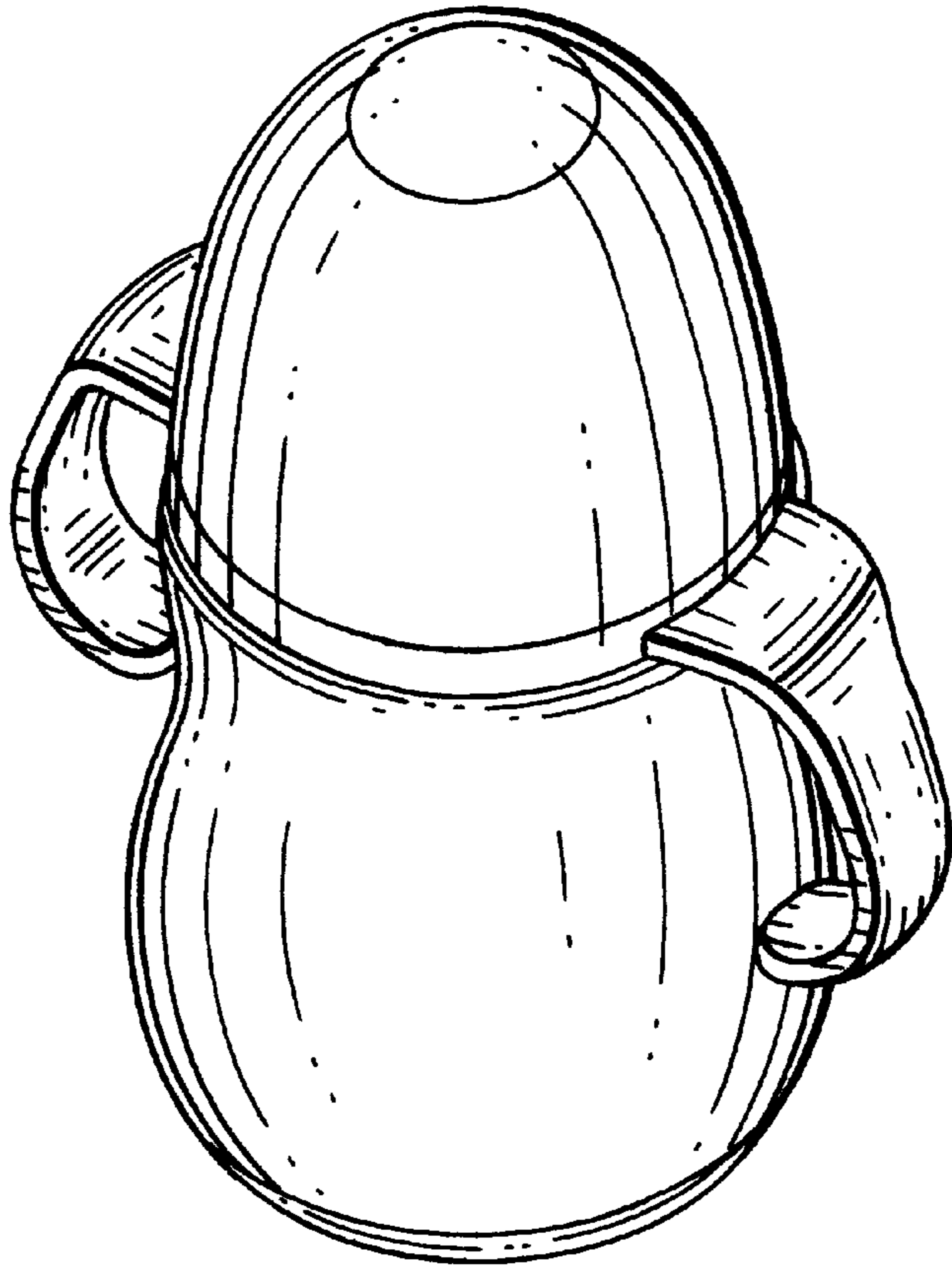
*FIG. 4*



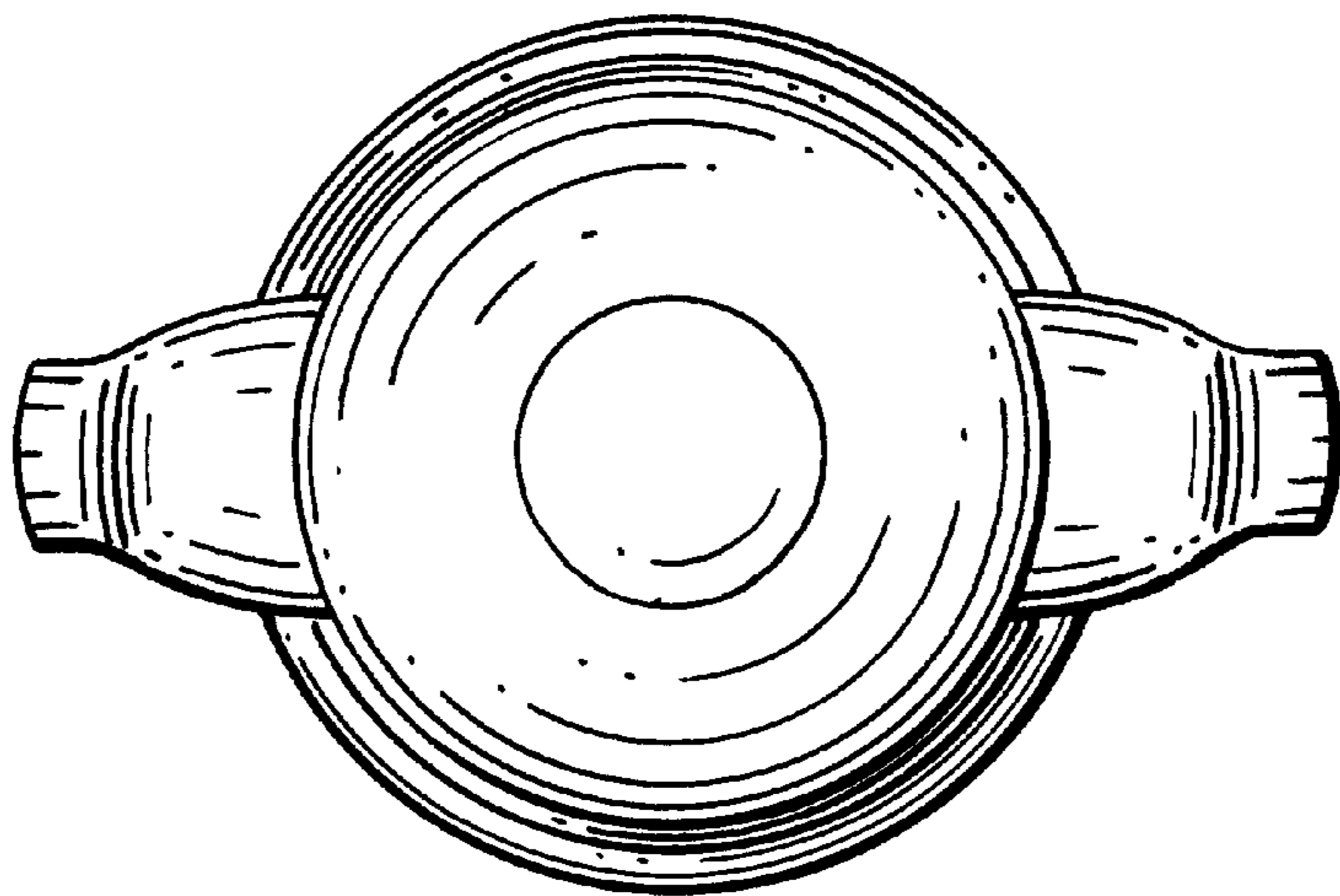
*FIG. 5*



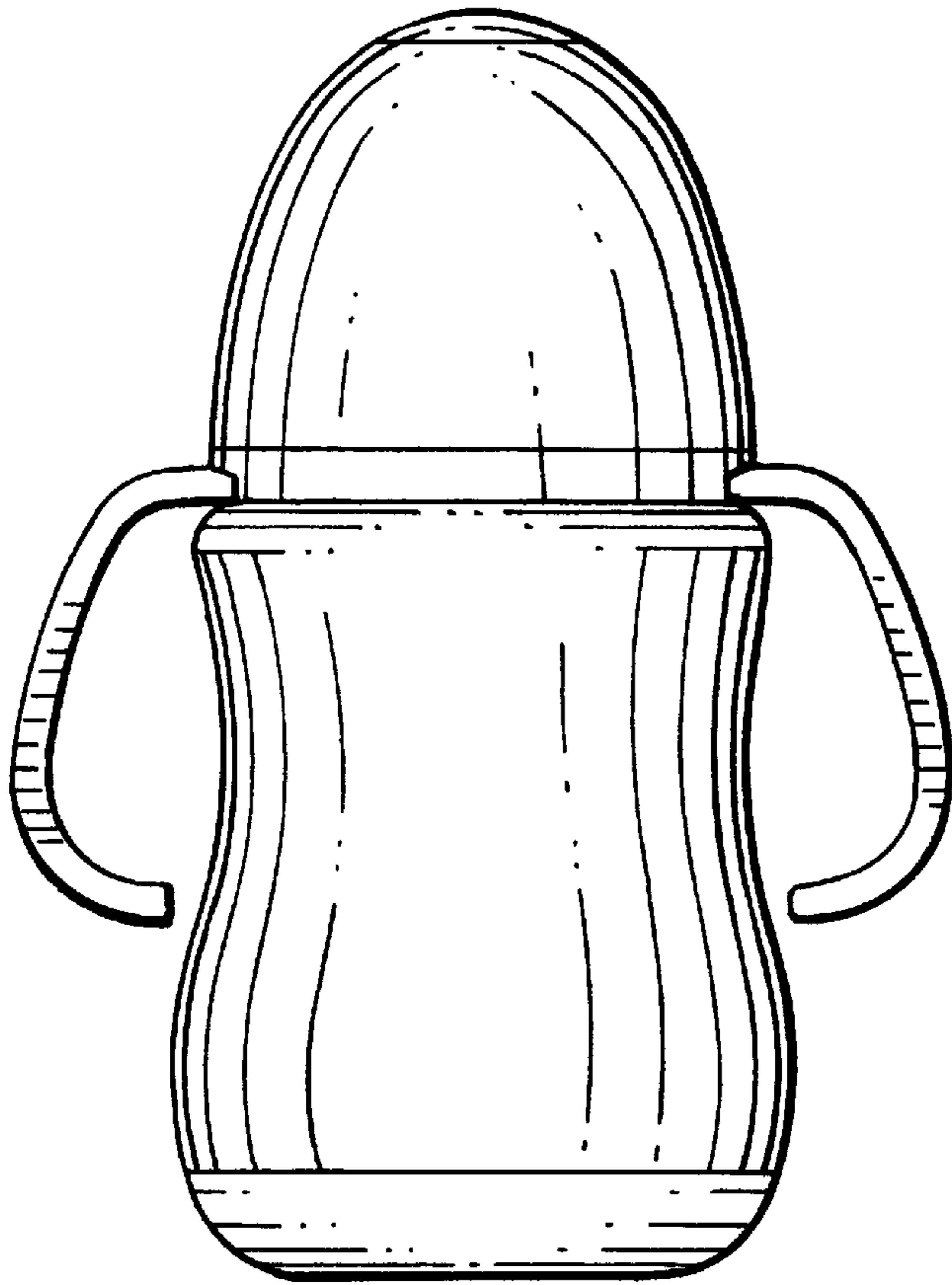
*FIG. 6*



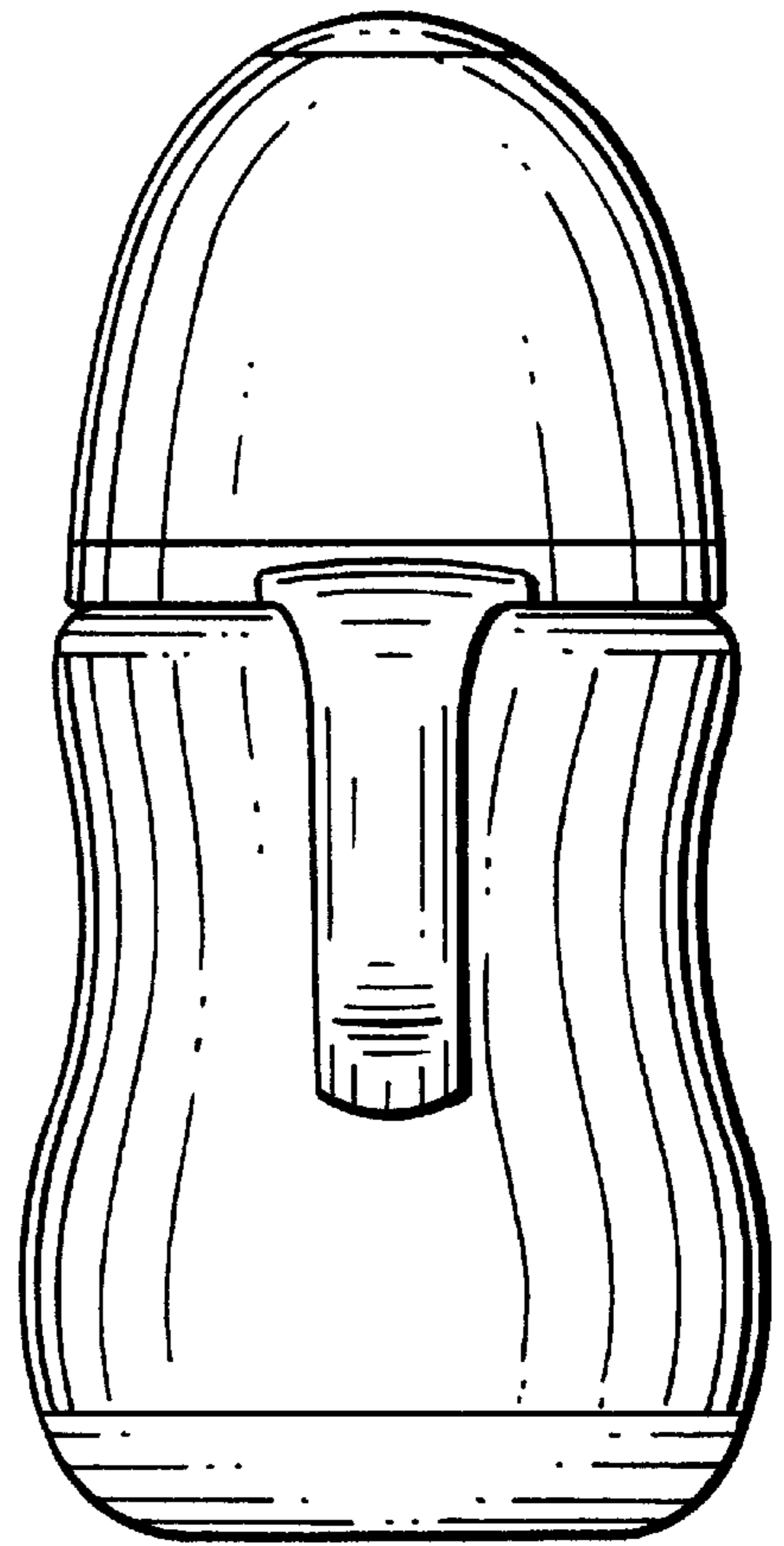
*FIG. 7*



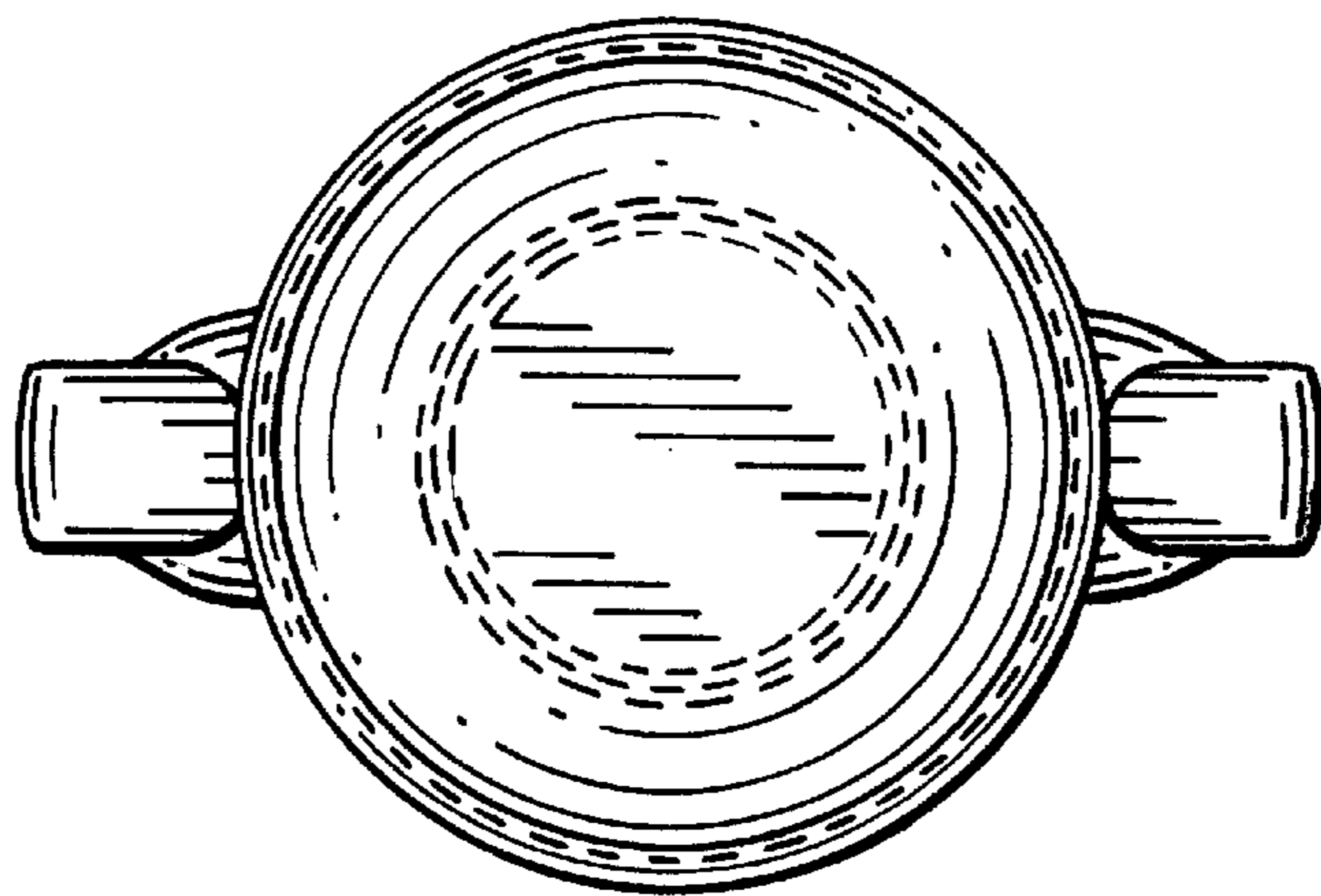
*FIG. 8*



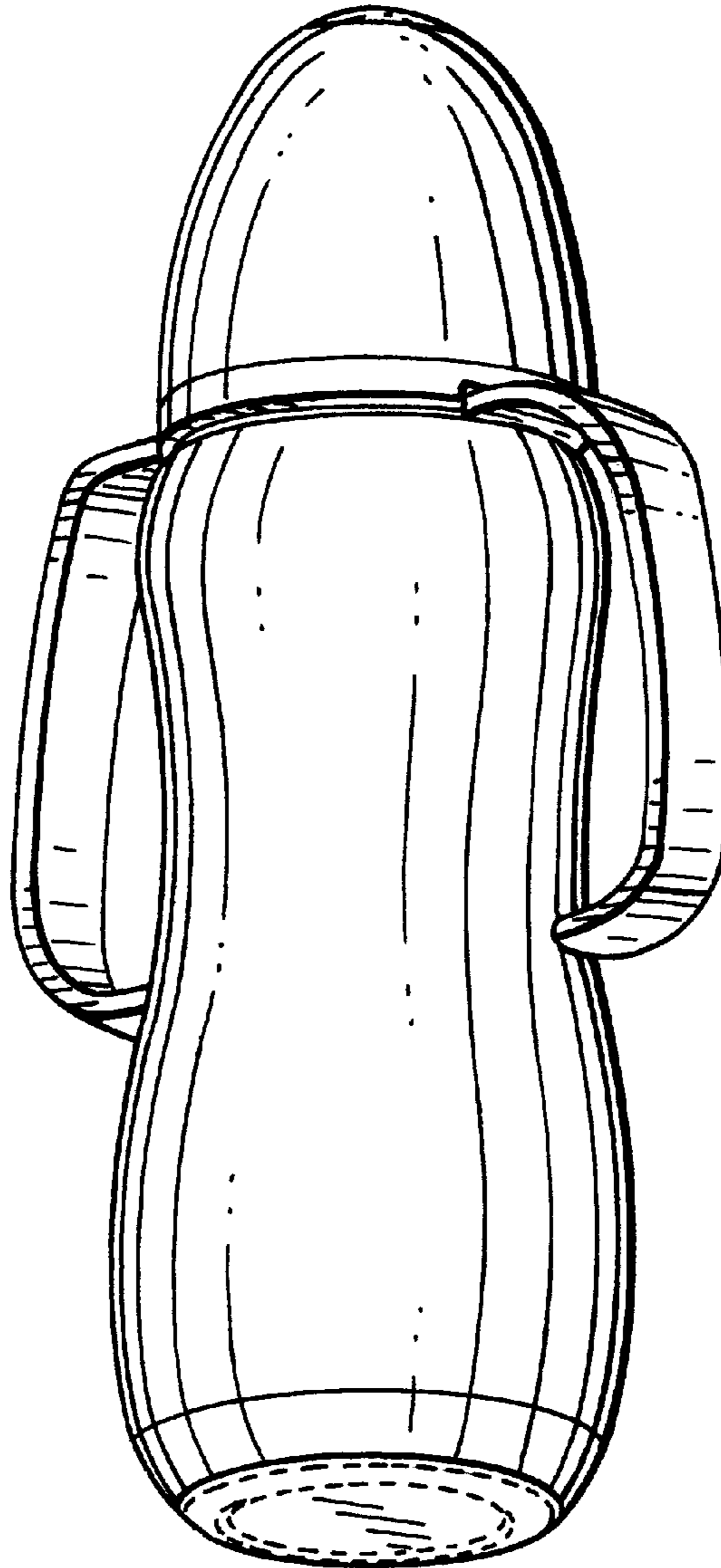
*FIG. 9*



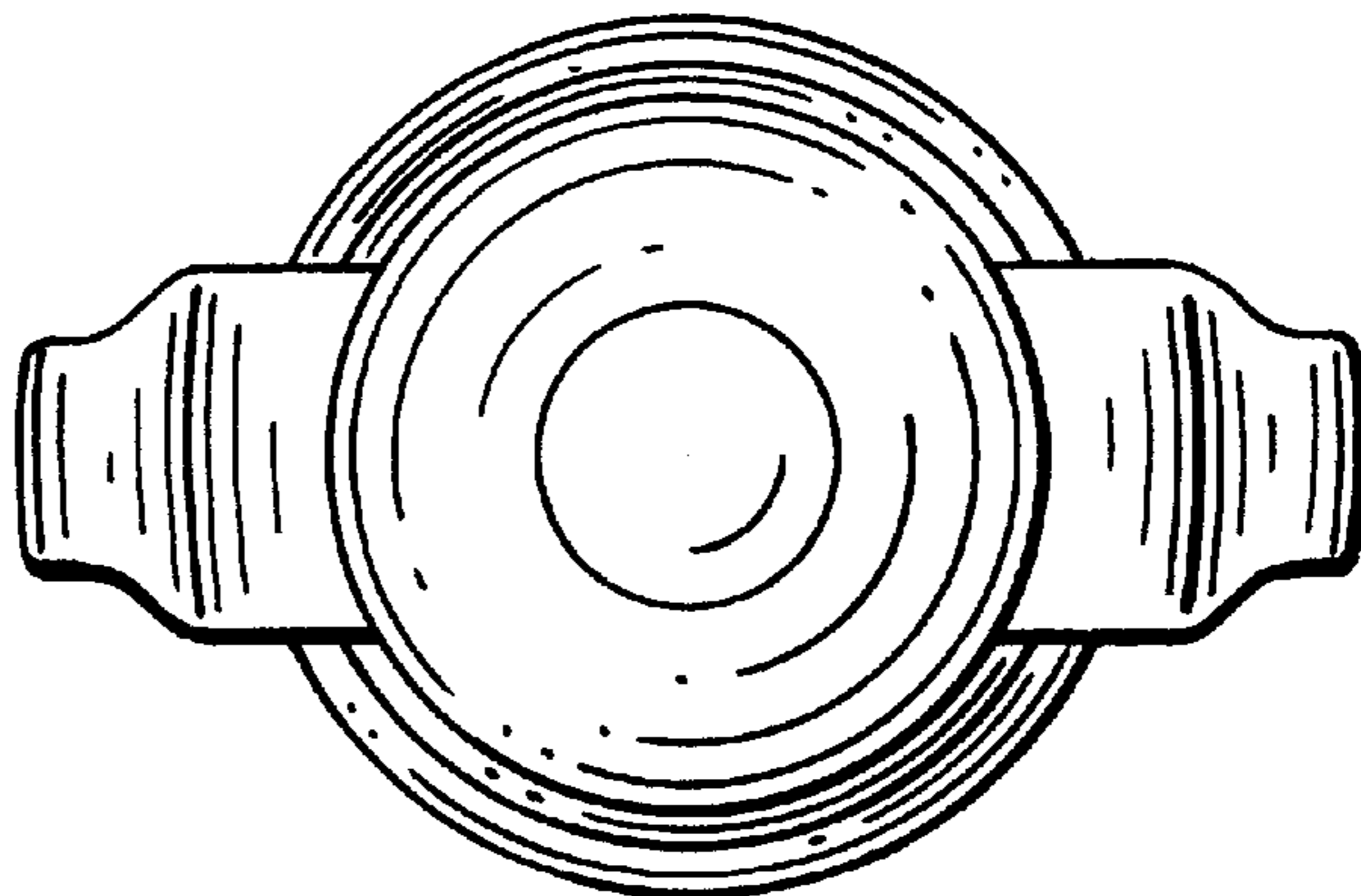
*FIG. 10*



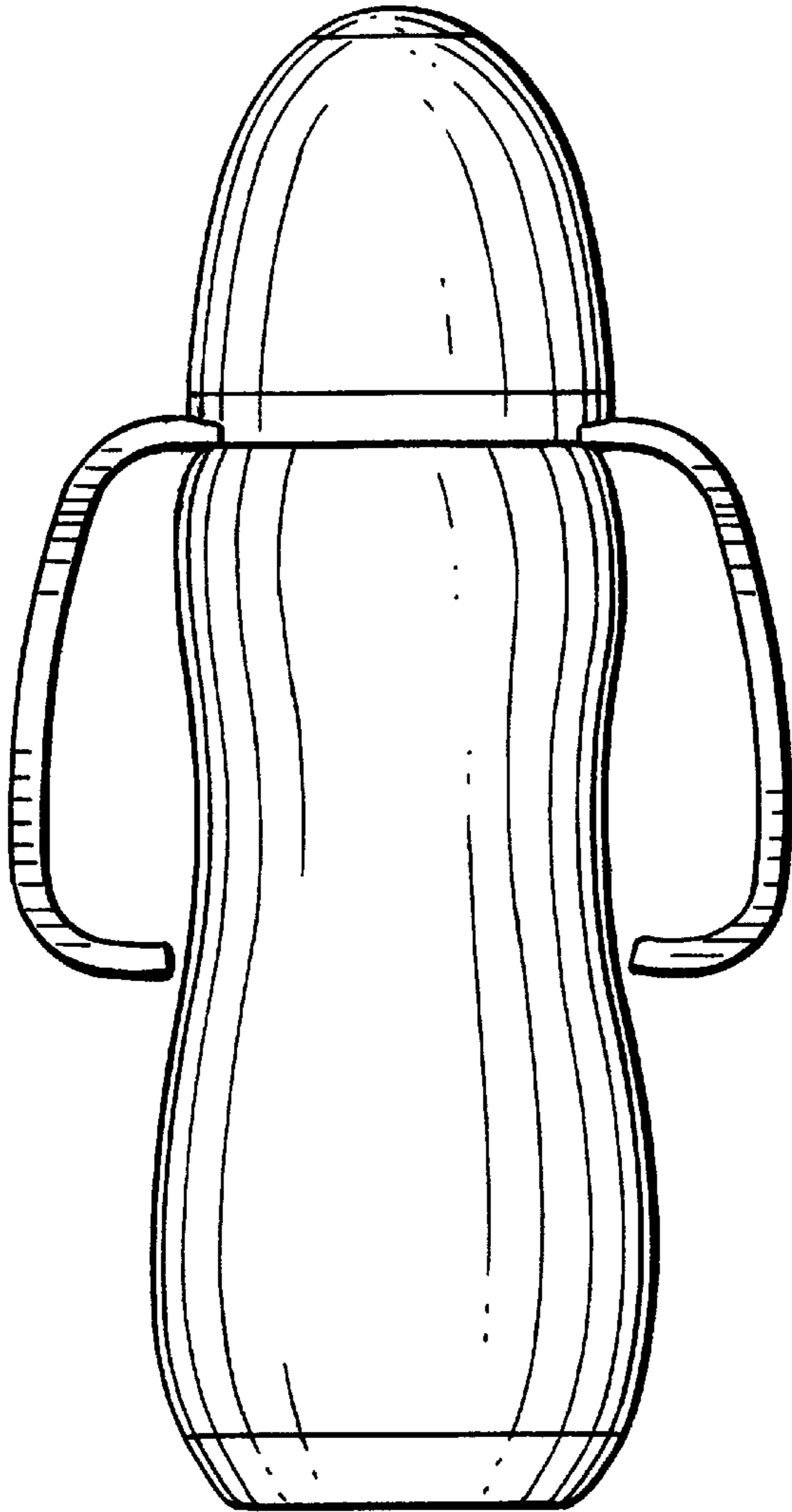
*FIG. 11*



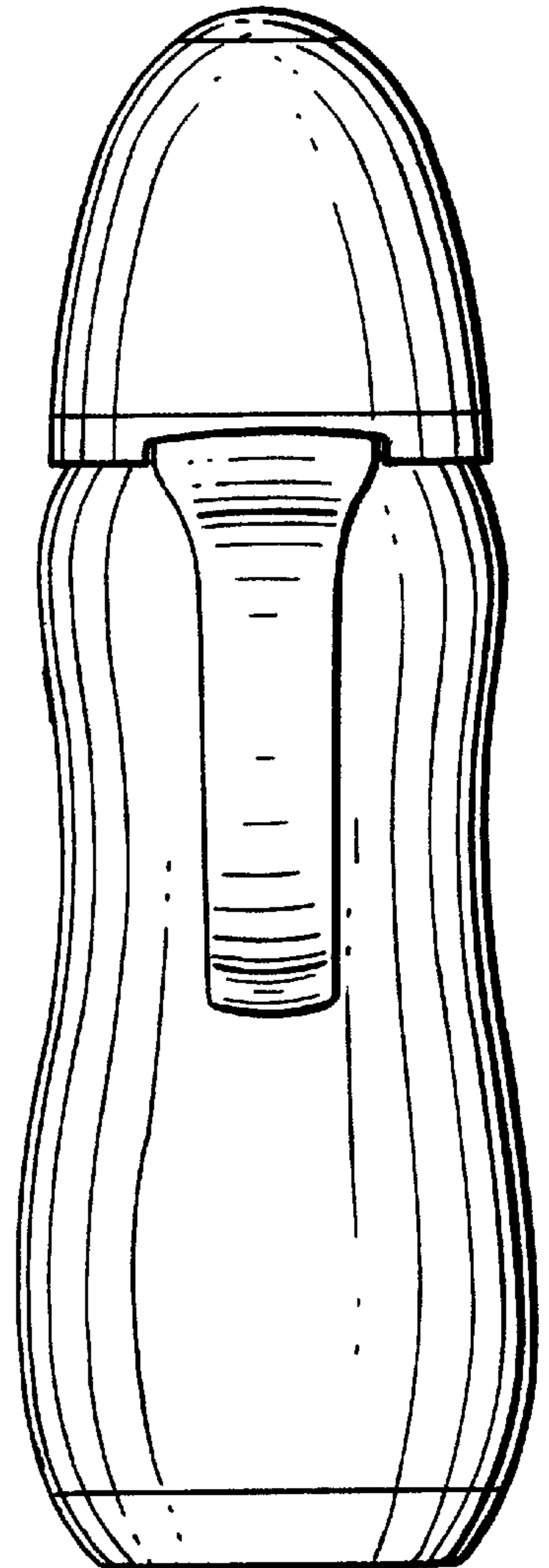
*FIG. 12*



*FIG. 13*



*FIG. 14*



*FIG. 15*

