



US00D425974S

# United States Patent [19]

[11] Patent Number: Des. 425,974

Esty et al.

[45] Date of Patent: \*\* May 30, 2000

- [54] GRILL FOR AN AIR HANDLING APPARATUS
- [75] Inventors: James A. Esty, Hampton, N.J.; Boris L. Muzikant, Pipersville, Pa.
- [73] Assignee: Kooltronic, Inc., Hopewell, N.J.
- [\*\*] Term: 14 Years
- [21] Appl. No.: 29/101,331
- [22] Filed: Mar. 1, 1999
- [51] LOC (7) Cl. .... 23-04
- [52] U.S. Cl. .... D23/354
- [58] Field of Search ..... D23/351-354, D23/333, 324, 325, 327, 335; 312/236; 62/277, 262, 263, 259.1

D. 390,647 2/1998 Melnar ..... D23/354

Primary Examiner—B. J. Bullock  
Attorney, Agent, or Firm—Morgan & Finnegan LLP

### [57] CLAIM

The ornamental design and apparatus for a grill for an air handling apparatus, as shown.

### DESCRIPTION

FIG. 1 is a perspective view of a grill for an air handling apparatus that embodies the principles of the invention; FIG. 2 is a front elevation view of the grill for an air handling apparatus as shown in FIG. 1; FIG. 3 is a top view of the grill for an air handling apparatus as shown in FIG. 1, the bottom being flat; FIG. 4 is a side elevation view of the grill for an air handling apparatus as shown in FIG. 1, the side opposite being a mirror image; FIG. 5 is a back elevation view of the grill for an air handling apparatus as shown in FIG. 1; and, FIG. 6 is an enlarged sectional view of the grill for an air handling apparatus taken along line 6—6 in FIG. 2 and viewed in the direction of the arrows.

### [56] References Cited

#### U.S. PATENT DOCUMENTS

- D. 265,123 6/1982 Hoyle .
- D. 300,459 3/1989 Hoyle ..... D23/354
- D. 360,458 7/1995 McColgin et al. .... D23/354
- D. 372,767 8/1996 Borges ..... D23/354

1 Claim, 5 Drawing Sheets

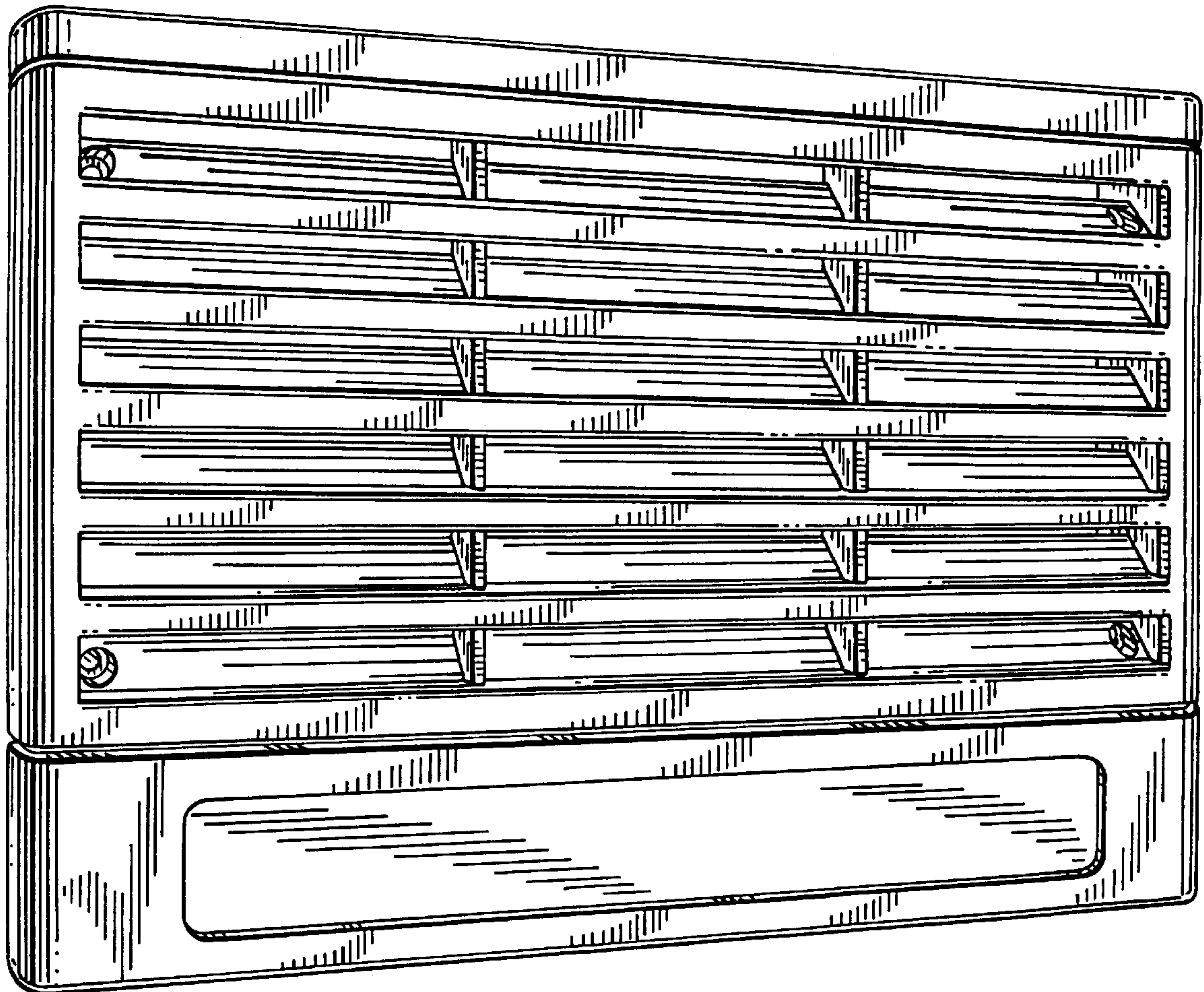

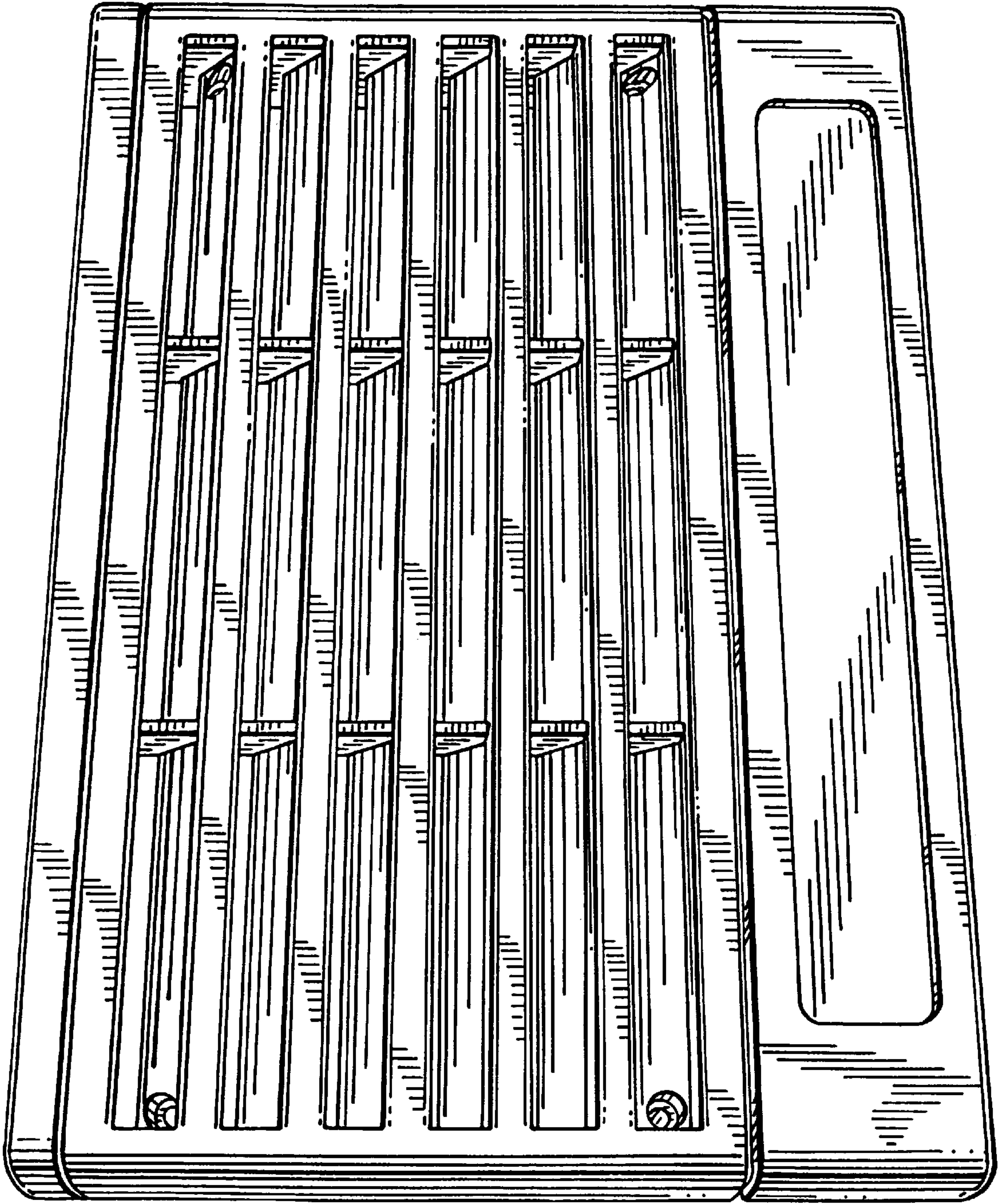
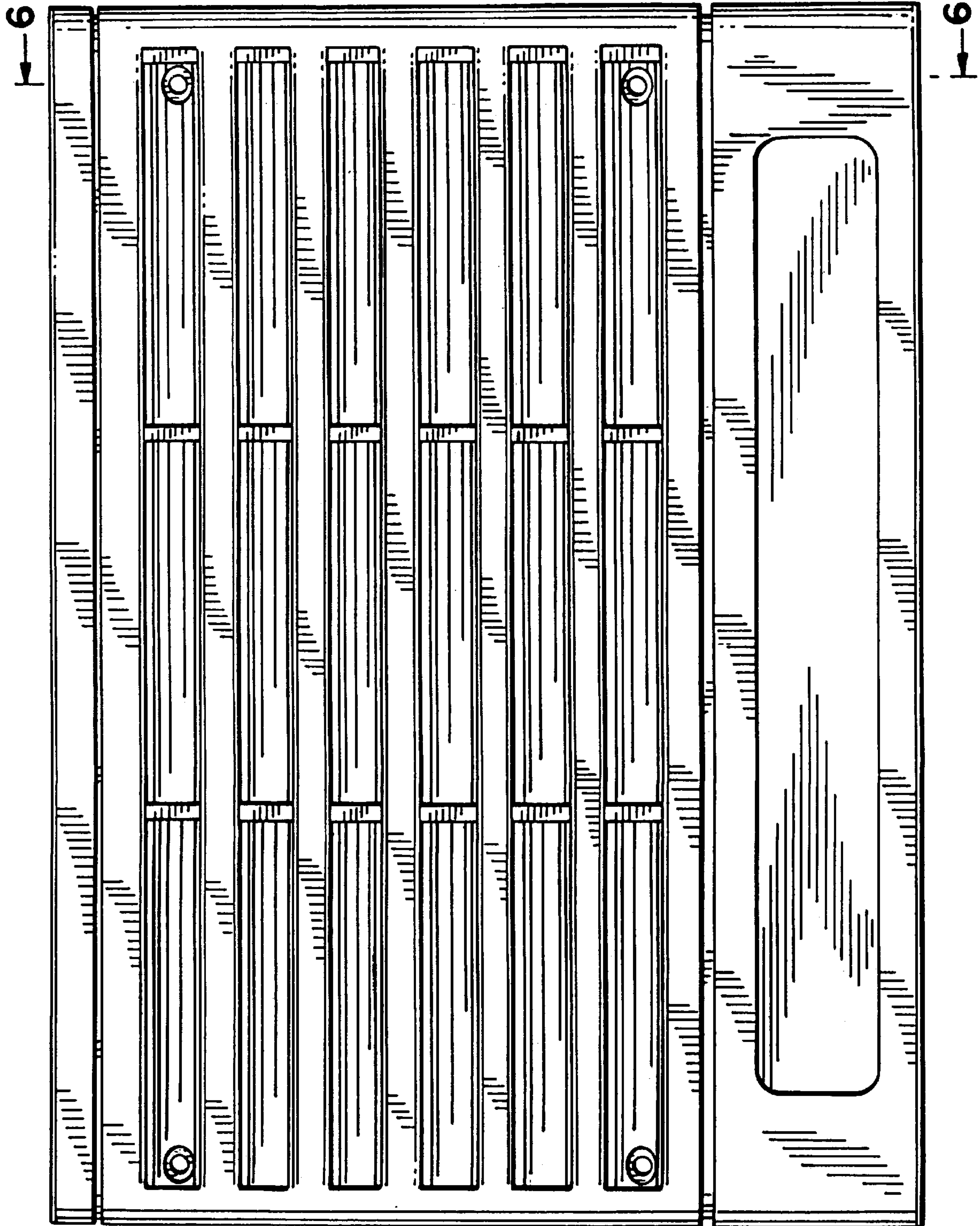

FIG. 1

FIG. 2



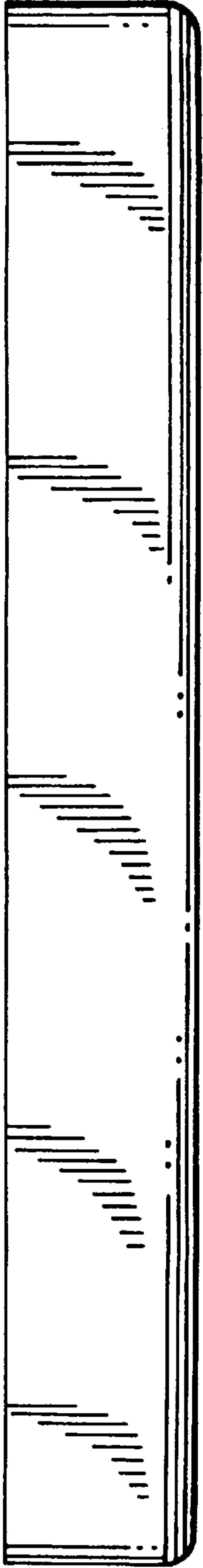

FIG. 3

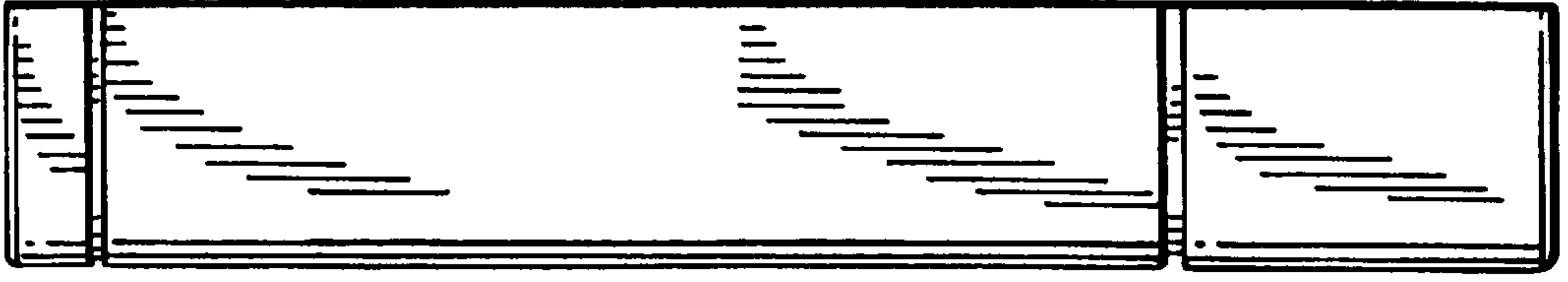
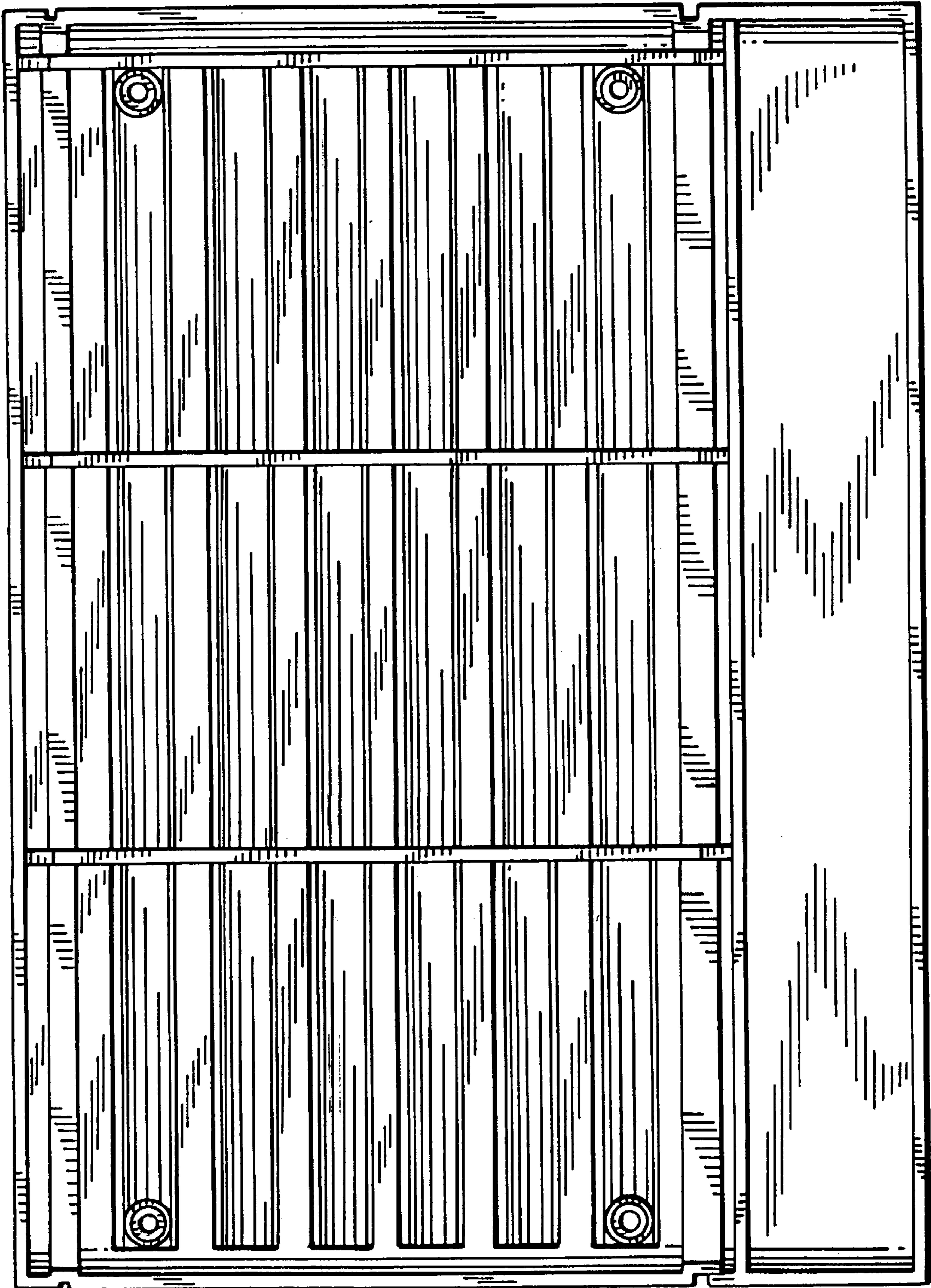

FIG. 4



FIG. 5



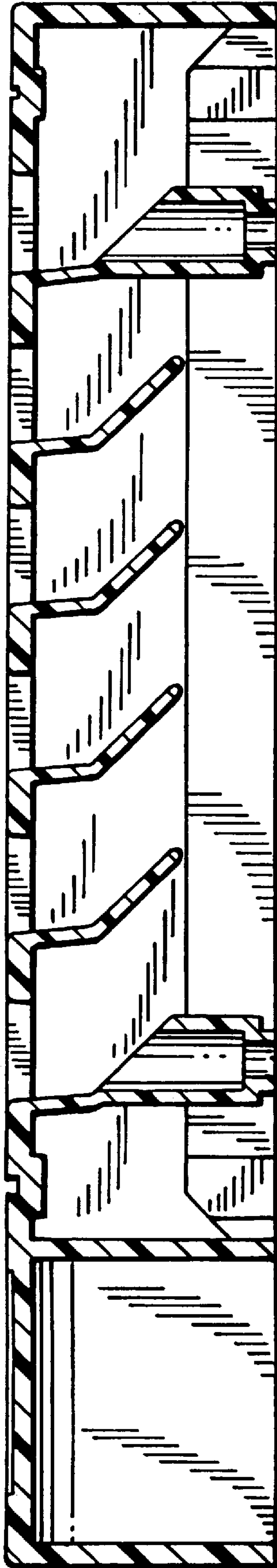

FIG. 6