



US00D425908S

United States Patent [19] Collins

[11] Patent Number: **Des. 425,908**

[45] Date of Patent: **** May 30, 2000**

[54] **HANDS FREE CRADLE FOR TELEPHONE**

[75] Inventor: **Christopher T. Collins**, Cary, N.C.

[73] Assignee: **Ericsson Inc.**, Research Triangle Park, N.C.

[**] Term: **14 Years**

[21] Appl. No.: **29/108,124**

[22] Filed: **Jul. 21, 1999**

5,535,274	7/1996	Braitberg	379/446
5,822,427	10/1998	Braitberg et al.	379/454
5,828,750	10/1998	Perala	379/446

FOREIGN PATENT DOCUMENTS

0269096	6/1988	European Pat. Off.	379/455
5-167657	7/1993	Japan	379/455

Primary Examiner—Jeffrey Asch
Attorney, Agent, or Firm—Herbert V. Kerner

[57] CLAIM

The ornamental design for a hands free cradle for a telephone, as shown and described.

Related U.S. Application Data

[63] Continuation-in-part of application No. 29/100,898, Feb. 19, 1999.

[51] **LOC (7) Cl.** **14-03**

[52] **U.S. Cl.** **D14/253**

[58] **Field of Search** D14/137, 138, D14/148, 147, 149–151, 140–142, 240, 241, 251, 253; 379/433–436, 419, 420, 428, 440, 454, 455, 446, 447; D13/107, 108; 320/110, 113, 114, 115

DESCRIPTION

FIG. 1 is a front view of the hands free cradle for a telephone showing my design;
 FIG. 2 is a side view thereof;
 FIG. 3 is an opposite side view thereof;
 FIG. 4 is a back view thereof;
 FIG. 5 is a top view thereof;
 FIG. 6 is a bottom view thereof;
 FIG. 7 shows a front perspective view of the hands free cradle of my design;
 FIG. 8 shows a front view of the hands free cradle of my design supporting a radiotelephone;
 FIG. 9 shows a side view thereof;
 FIG. 10 shows a back view thereof;
 FIG. 11 shows a top view thereof; and,
 FIG. 12 shows a perspective view thereof.
 The dashed lines shown herein are for illustrative purposes only and form no part of the claimed design.

[56] References Cited

U.S. PATENT DOCUMENTS

D. 354,961	1/1995	Richards et al.	D14/253
D. 362,004	9/1995	Nakano et al.	D14/149 X
D. 368,479	4/1996	Larson	D14/149 X
D. 372,189	7/1996	Andis et al.	D8/373
D. 389,159	1/1998	Patterson et al.	D14/253
D. 412,910	8/1999	Peiker	D14/253
D. 413,607	9/1999	Lindahl	D14/253
5,142,573	8/1992	Umezawa	455/90 X
5,189,358	2/1993	Tomura et al.	455/89

1 Claim, 10 Drawing Sheets

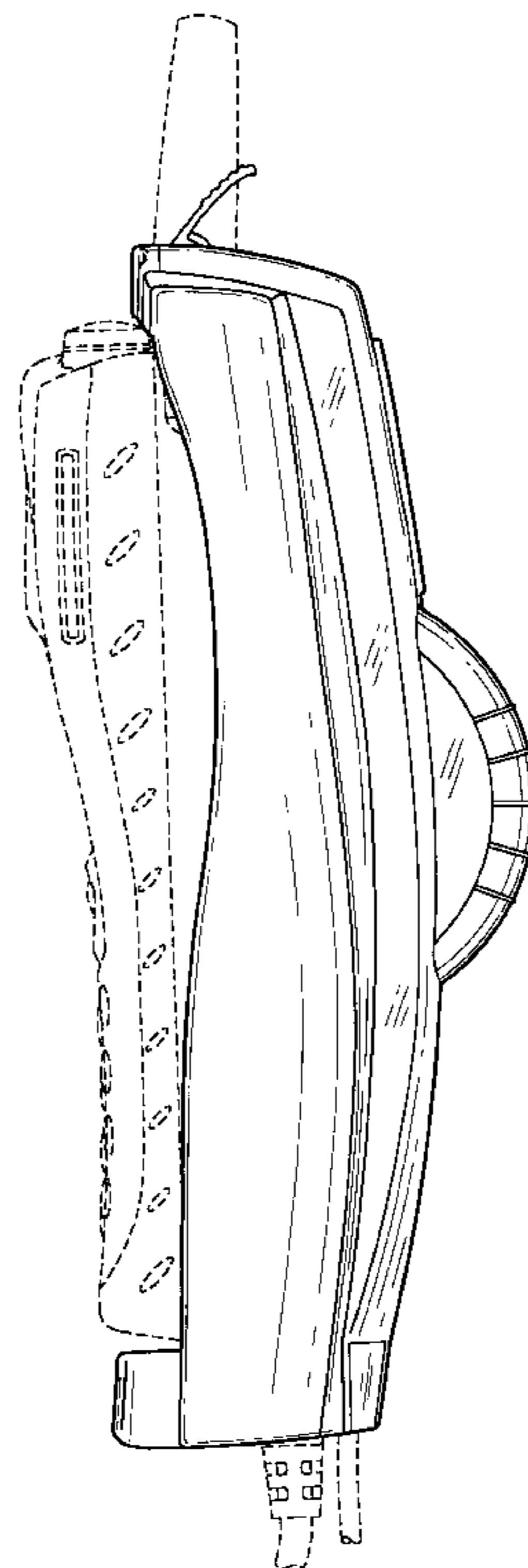

FIG. 1

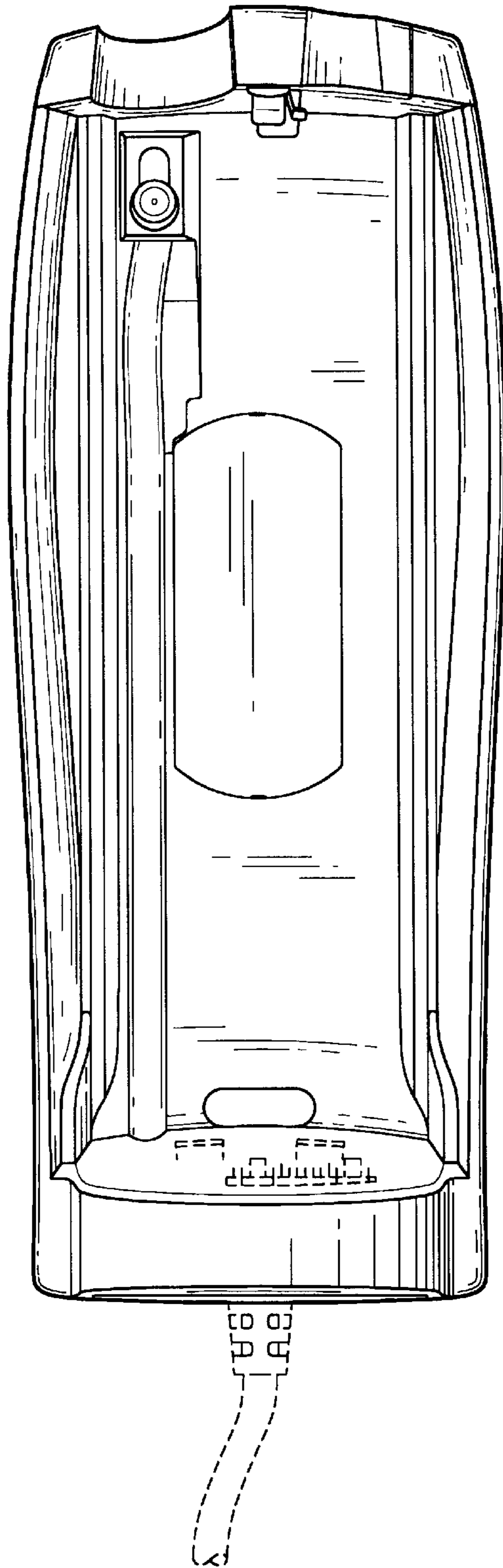

FIG. 2

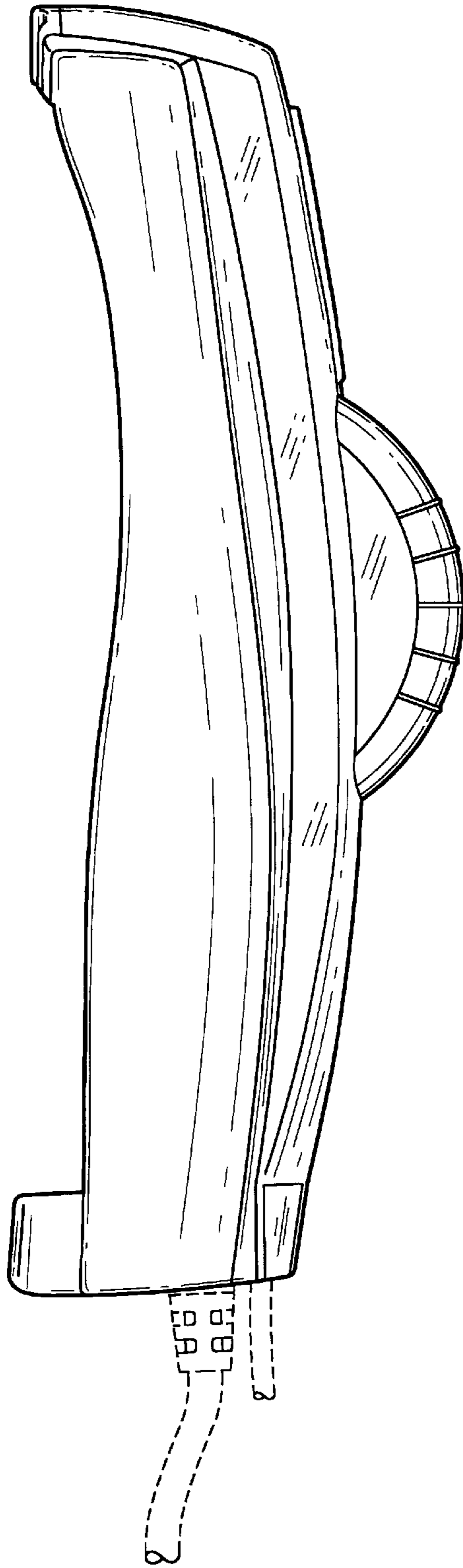

FIG. 3

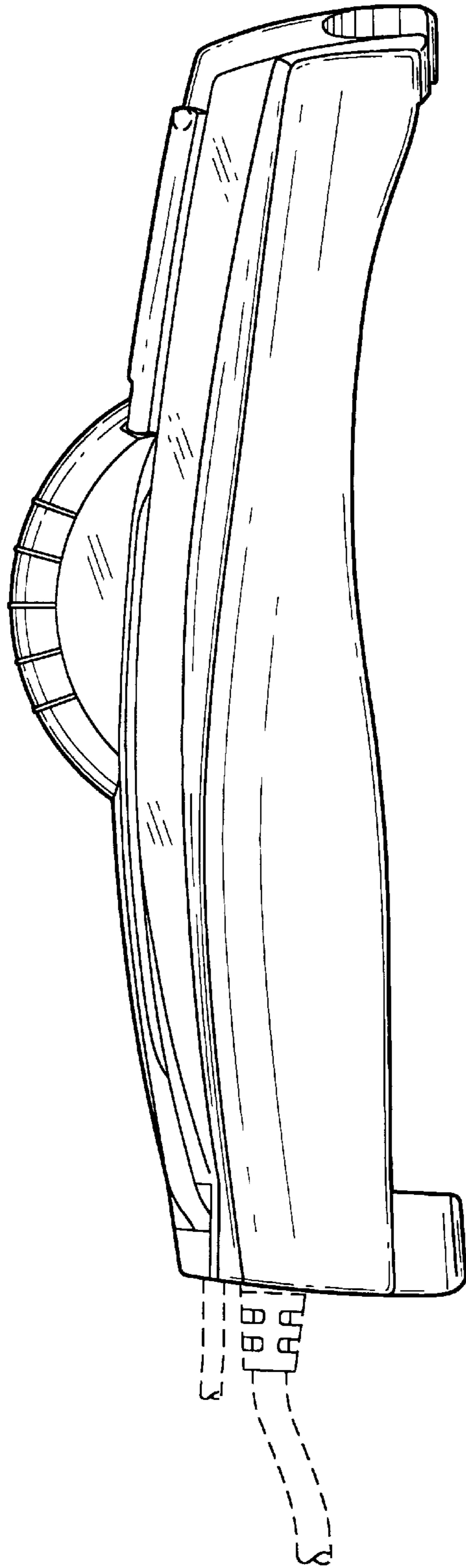

FIG. 4

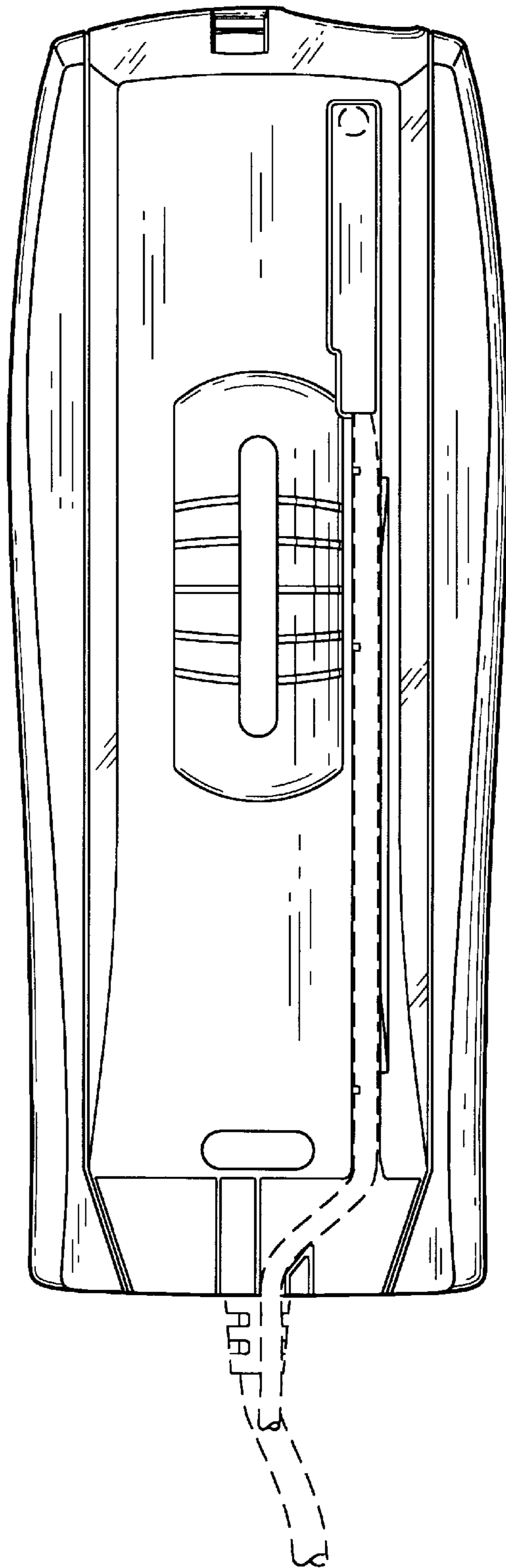

FIG. 5

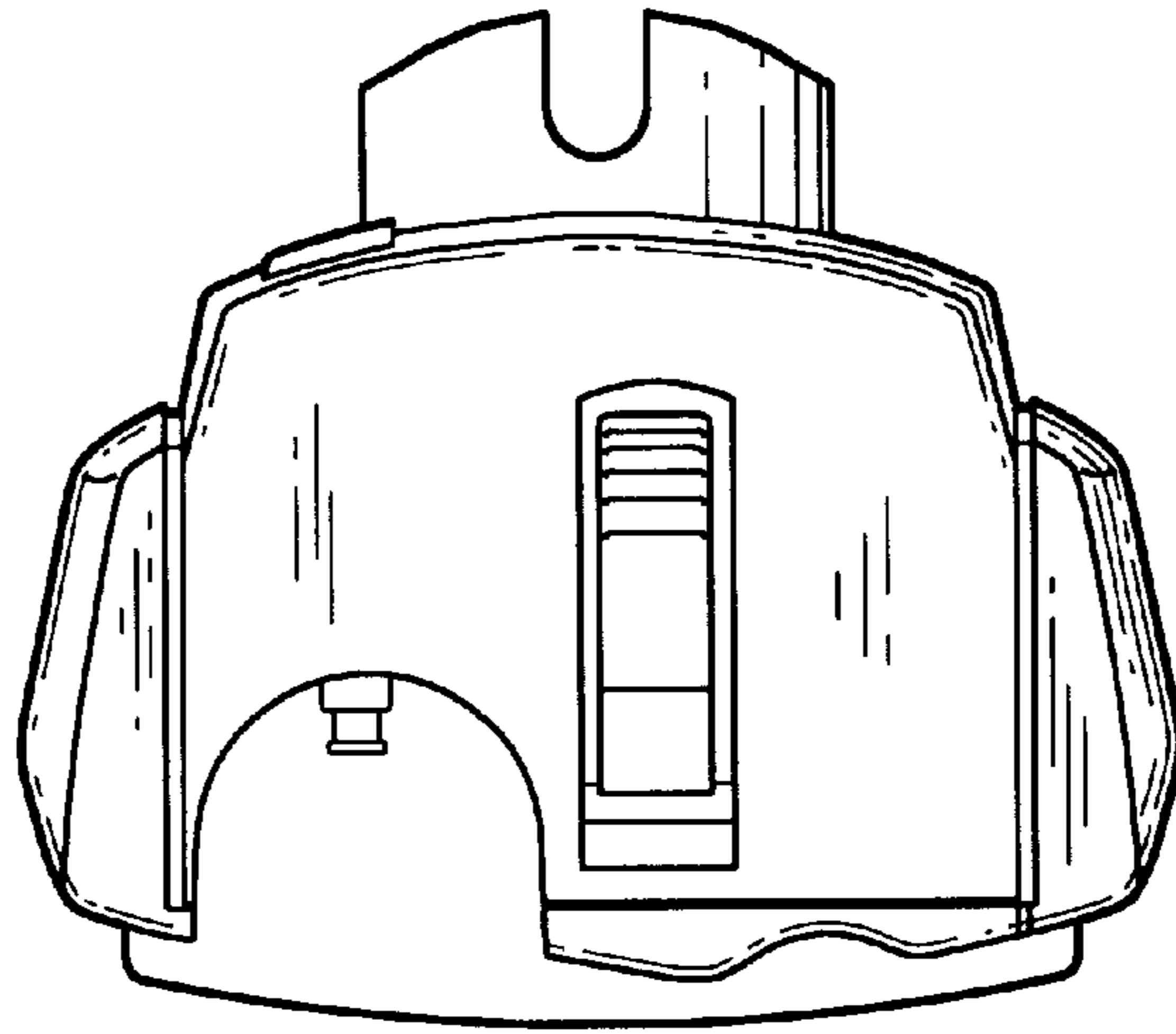

FIG. 6

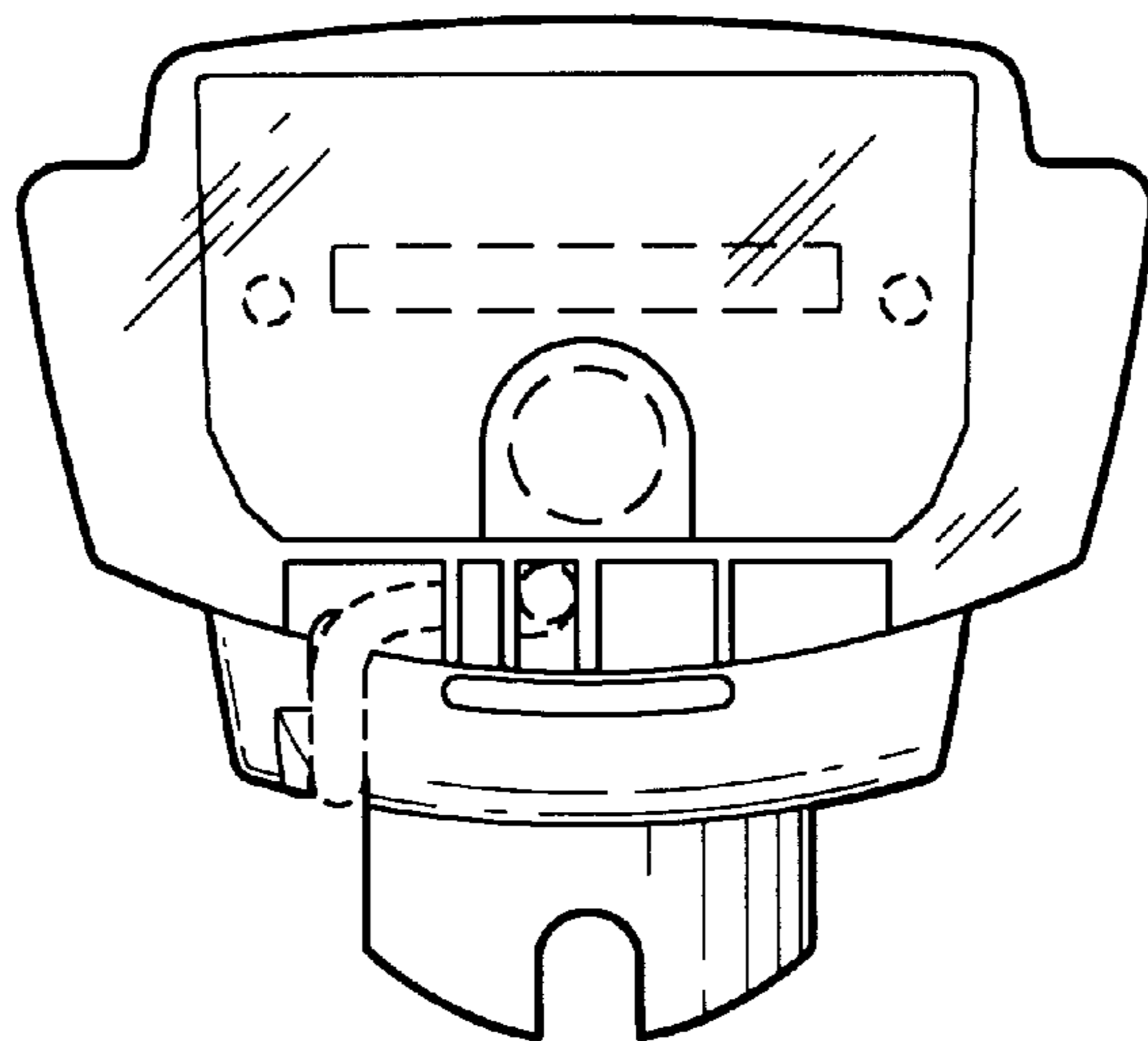

FIG. 7



FIG. 8

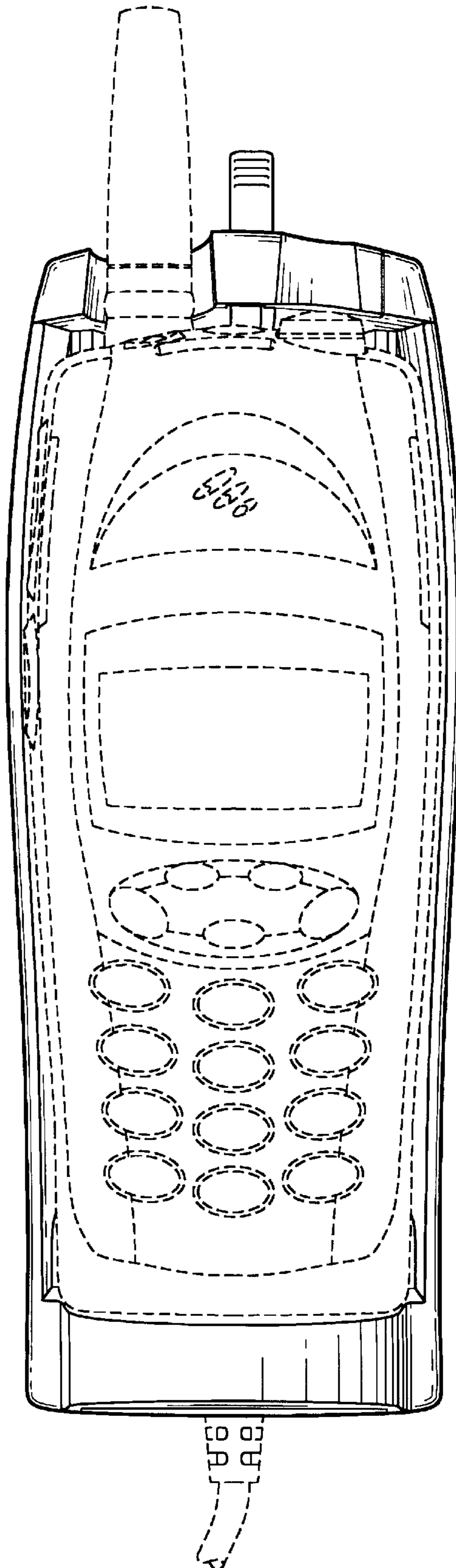

FIG. 9

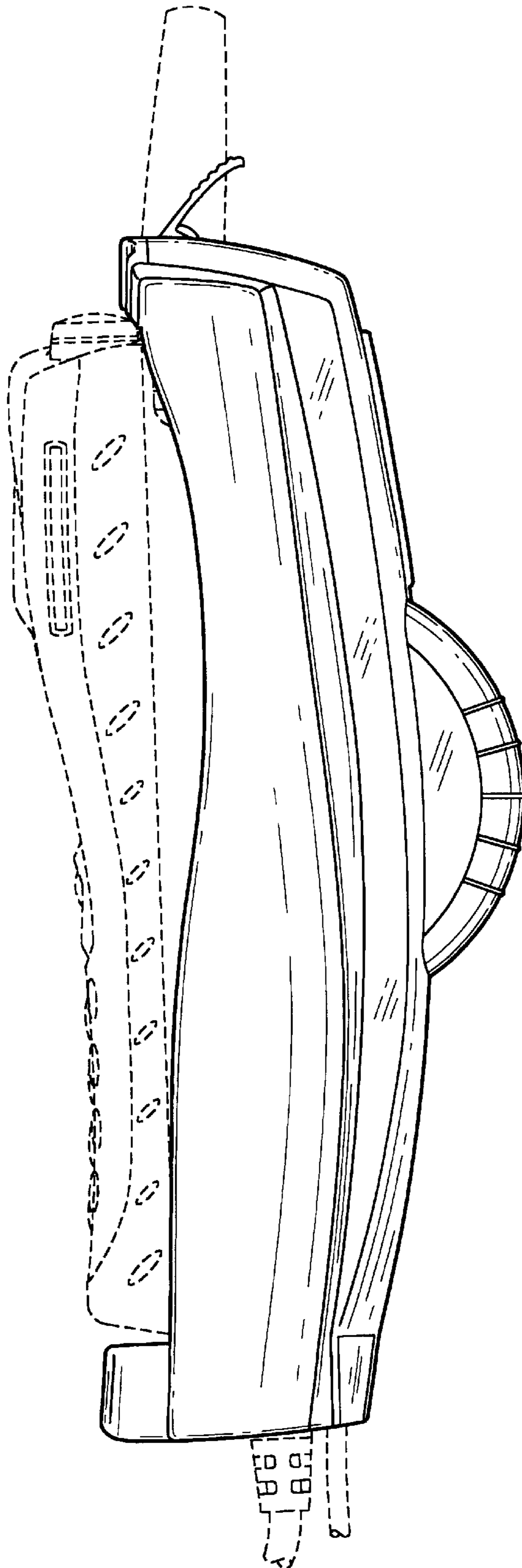

FIG. 10

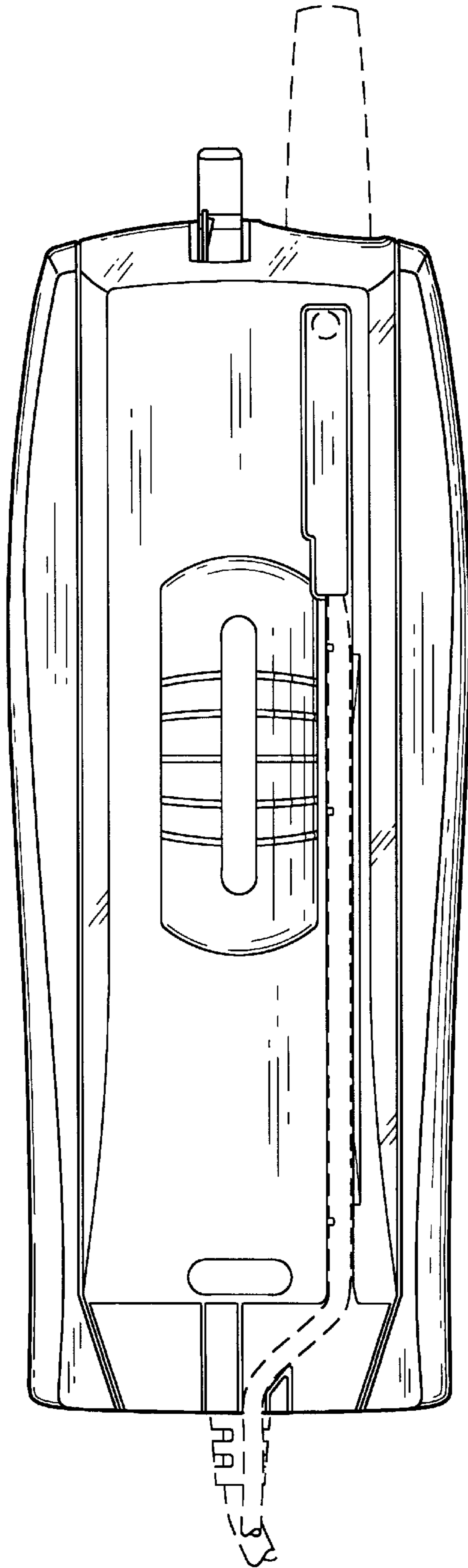

FIG. 12

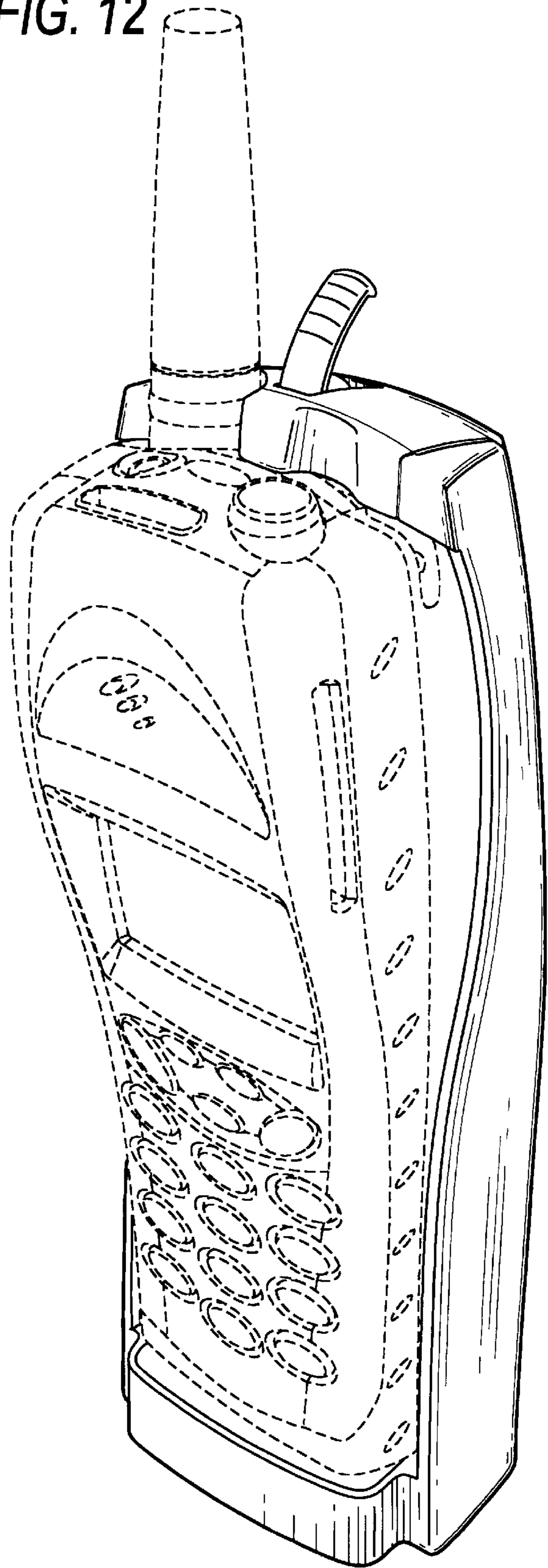

FIG. 11

