



US00D425890S

United States Patent [19]
Kataoka

[11] **Patent Number: Des. 425,890**

[45] **Date of Patent: ** May 30, 2000**

[54] **TAPE PLAYER AND RECORDER
COMBINED WITH RADIO RECEIVER**

[75] Inventor: **Tetsu Kataoka**, Tokyo, Japan

[73] Assignee: **Sony Corporation**

[**] Term: **14 Years**

[21] Appl. No.: **29/096,764**

[22] Filed: **Nov. 20, 1998**

[51] **LOC (7) Cl.** **14-01**

[52] **U.S. Cl.** **D14/163**

[58] **Field of Search** D14/124, 160-168,
D14/188, 192-198; 455/344, 347, 350,
351

[56] **References Cited**

U.S. PATENT DOCUMENTS

- D. 312,255 11/1990 Yoshii D14/188 X
- D. 350,749 9/1994 Wada et al. D14/163
- D. 361,766 8/1995 Mackay D14/167

OTHER PUBLICATIONS

Catalog "89", pp. 100-101, Sony (Jul. 1998).

Primary Examiner—Nanda Bondade

Attorney, Agent, or Firm—Rader, Fishman & Grauer

[57] **CLAIM**

The ornamental design for a tape player and recorder combined with a radio receiver, as shown and described.

DESCRIPTION

FIG. 1 is a perspective view of a tape player and recorder combined with a radio receiver showing my new design; FIG. 2 is a front elevational view thereof; FIG. 3 is a rear elevational view thereof. FIG. 4 is a top plan view thereof; FIG. 5 is a bottom plan view thereof; FIG. 6 is a left side elevational view thereof; FIG. 7 is a right side elevational view thereof; and, FIG. 8 is another perspective view thereof, wherein the lid portion thereof is in the open position, the broken lines showing of the inside portion is for illustrative purposes only and form no part of the claimed design.

1 Claim, 5 Drawing Sheets

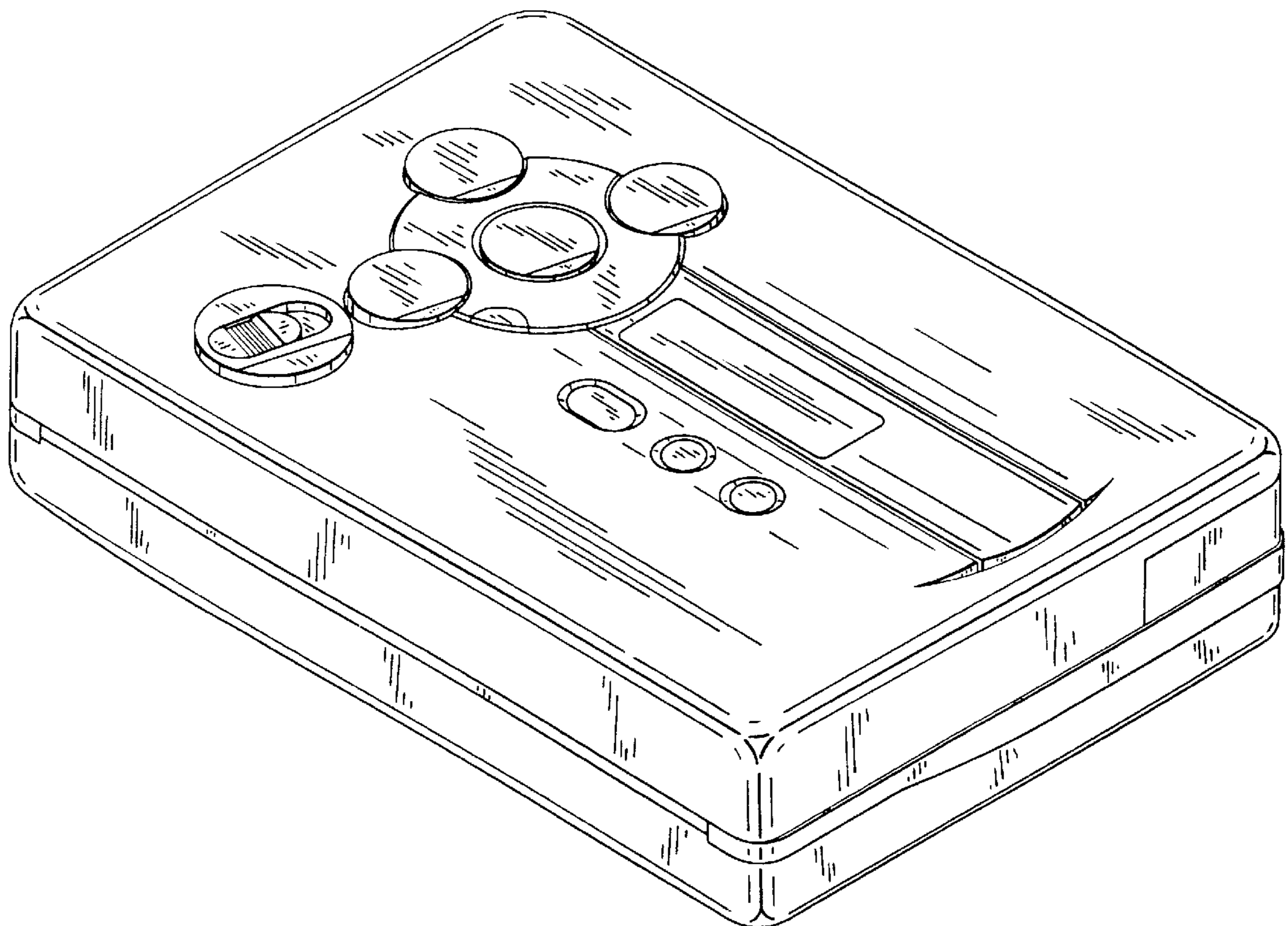

FIG. 1

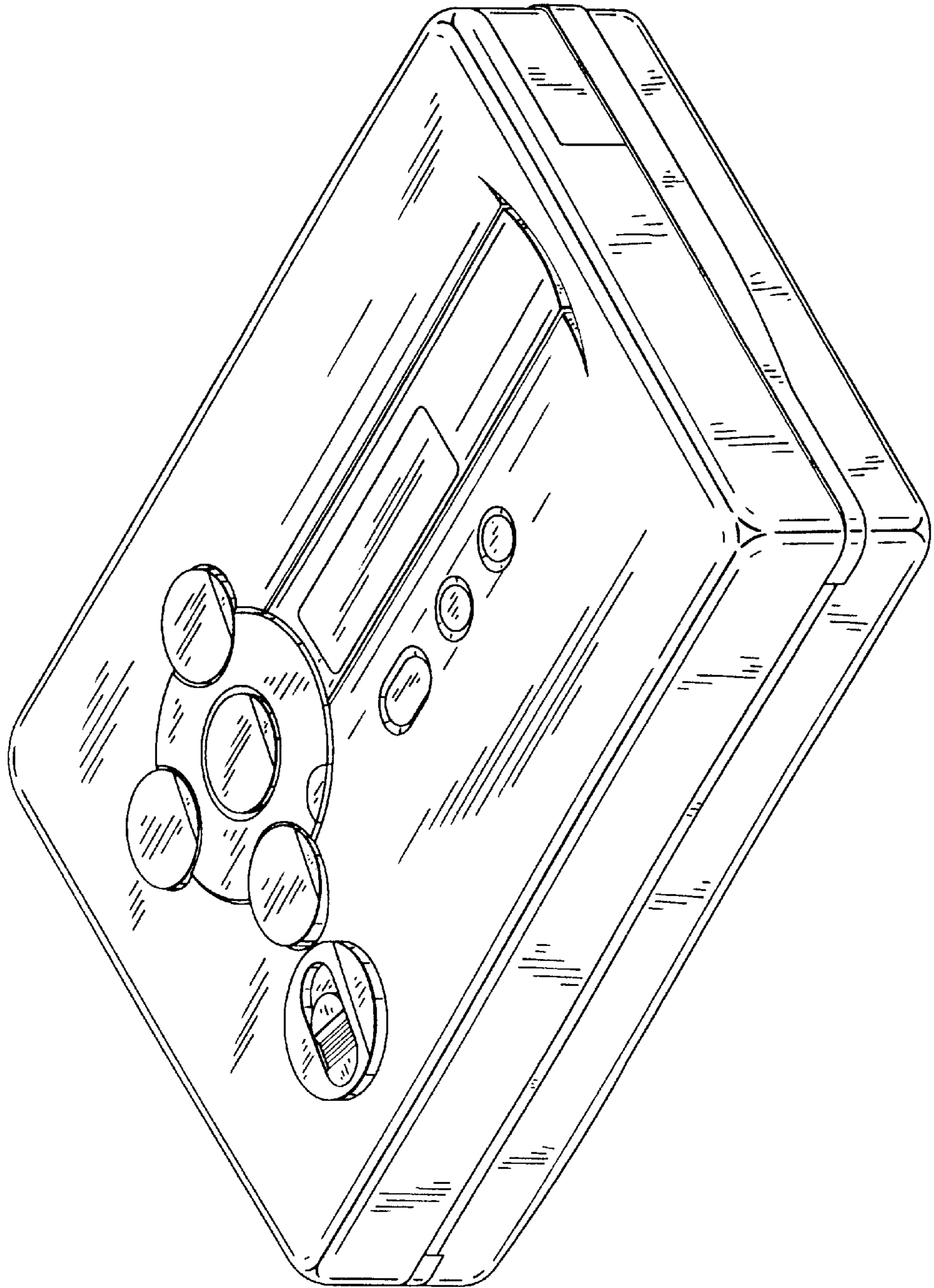

FIG. 2

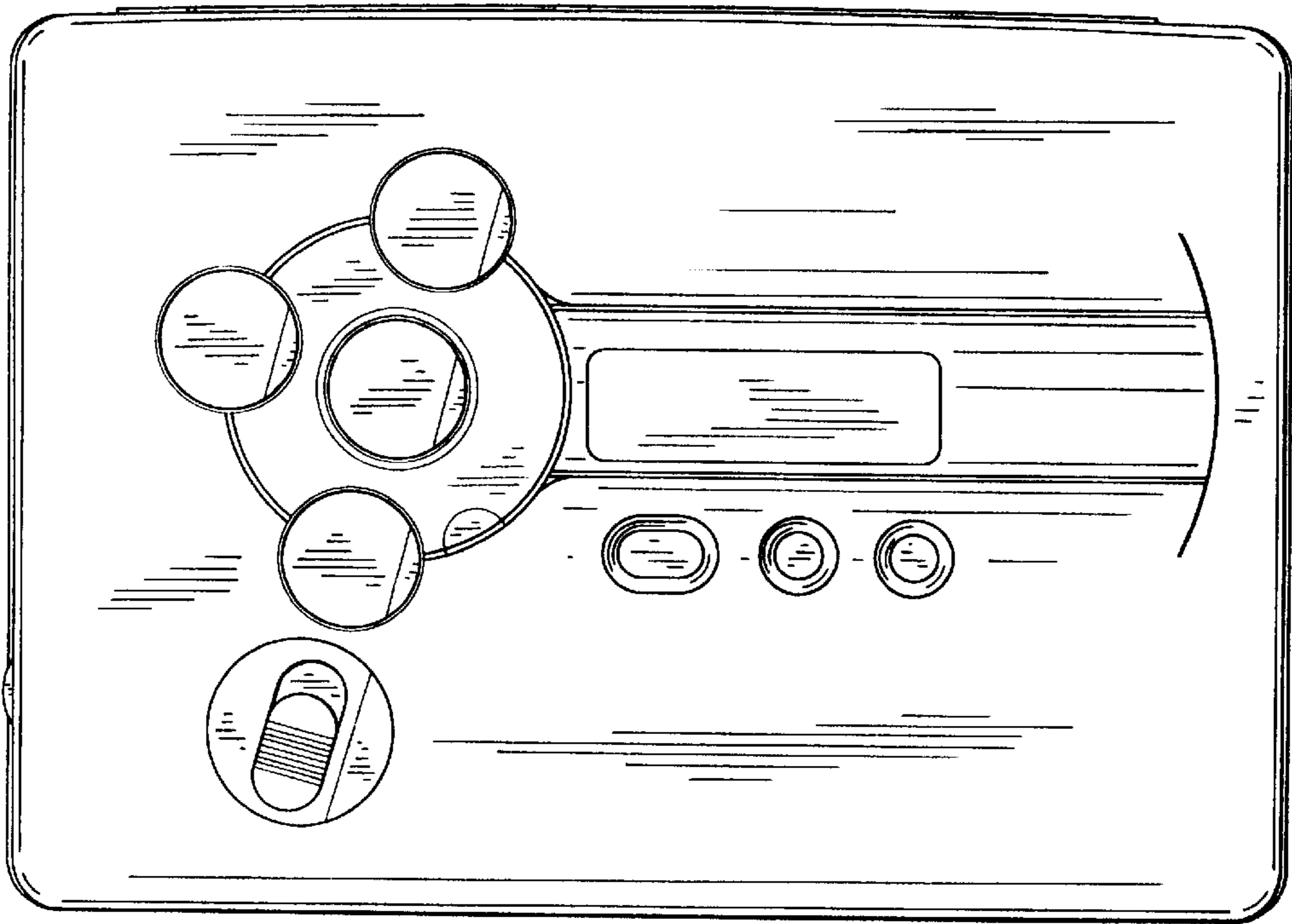

FIG. 3

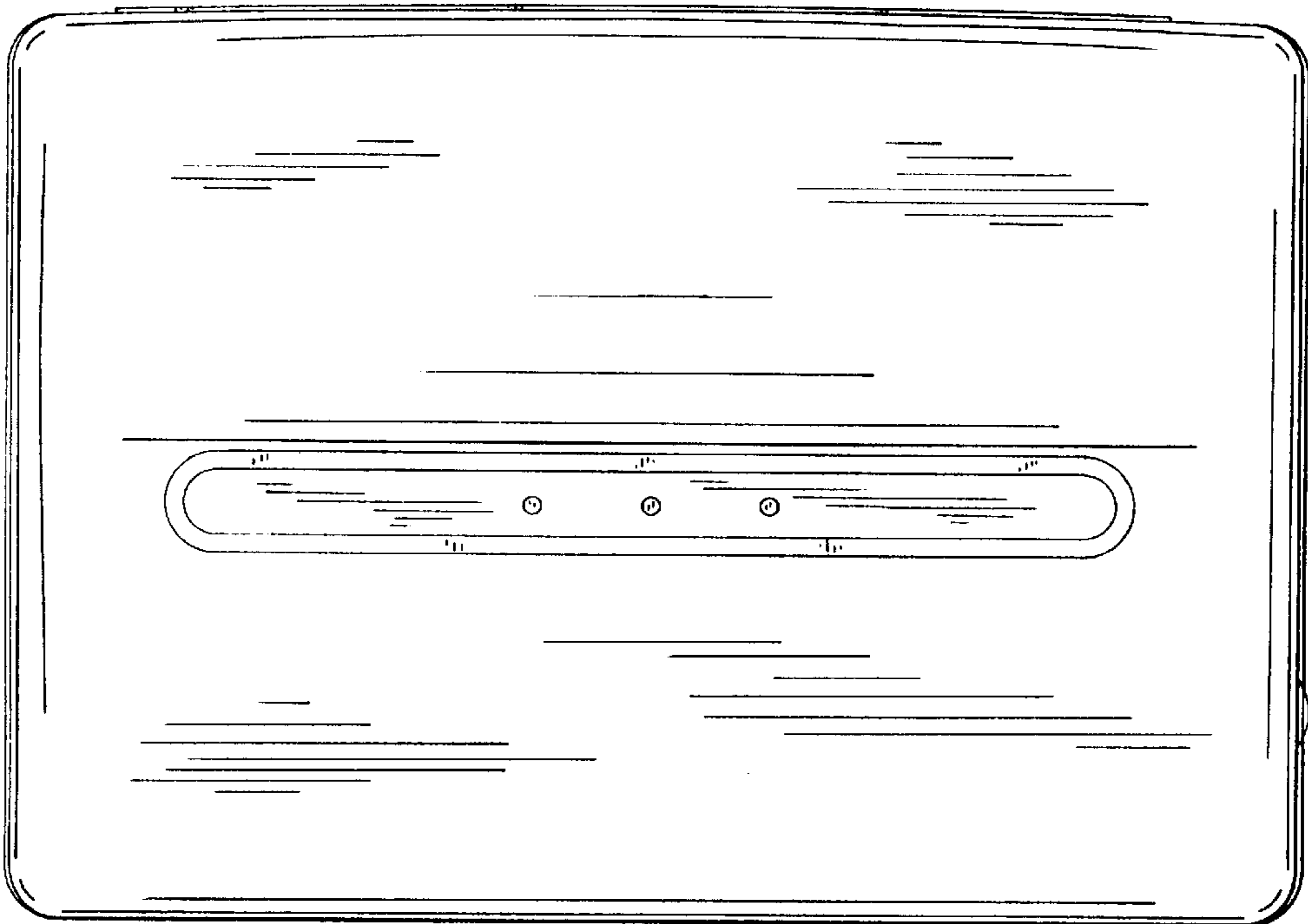

FIG. 4

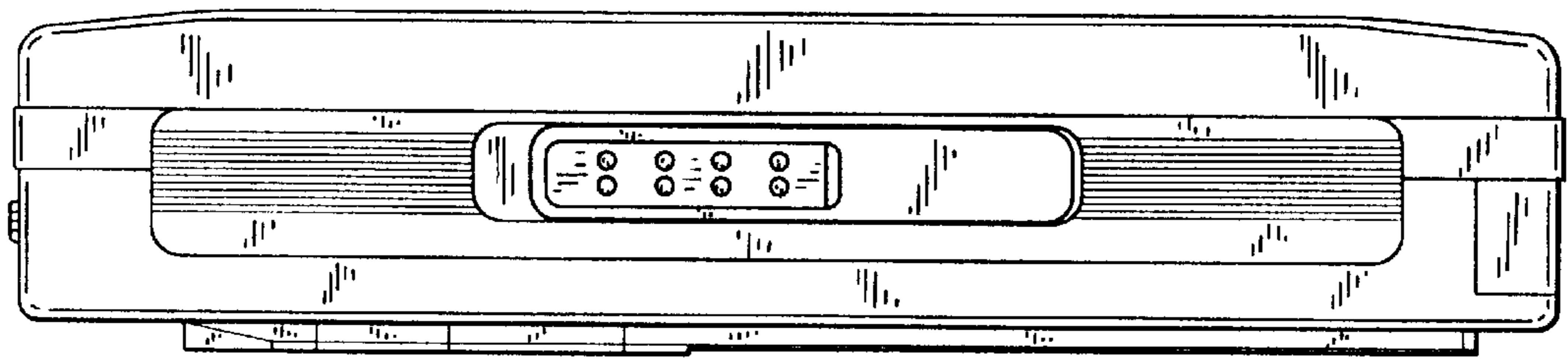

FIG. 5

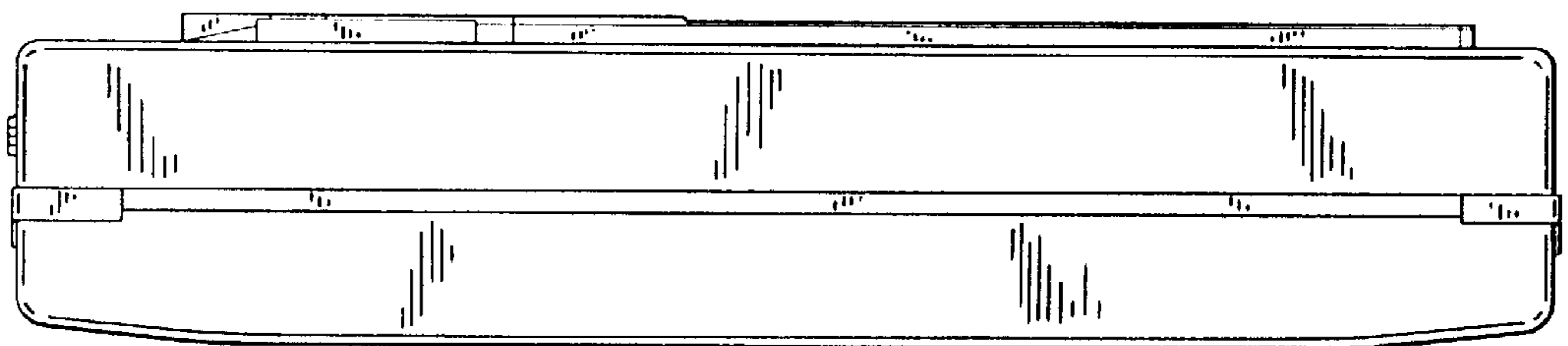

FIG. 6

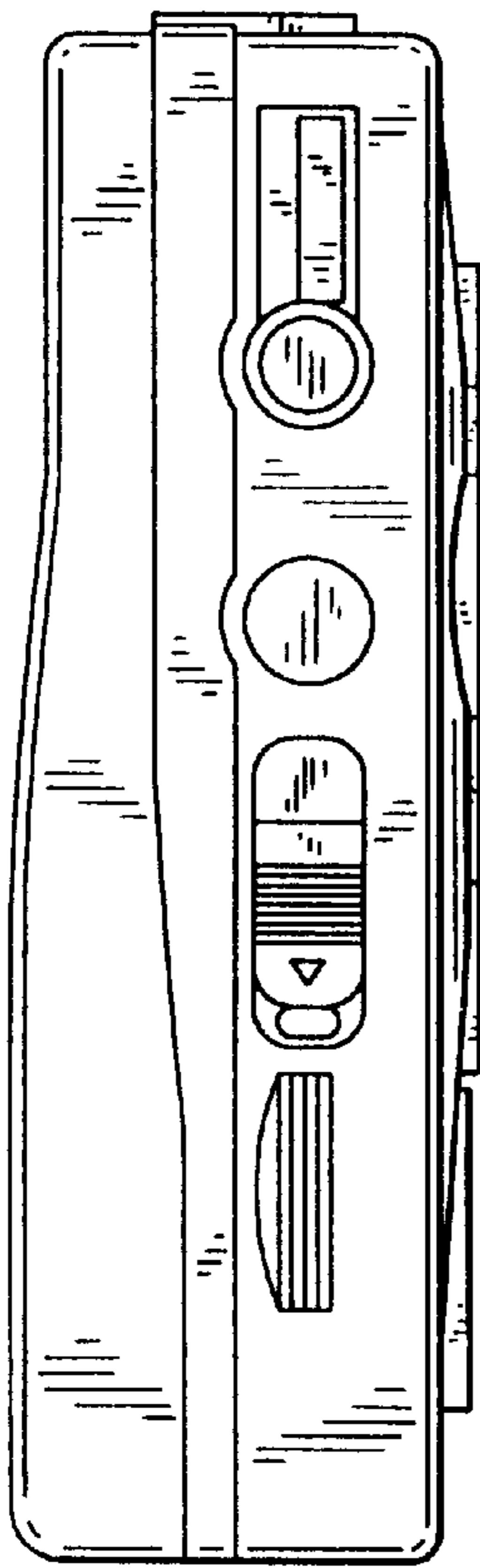

FIG. 7

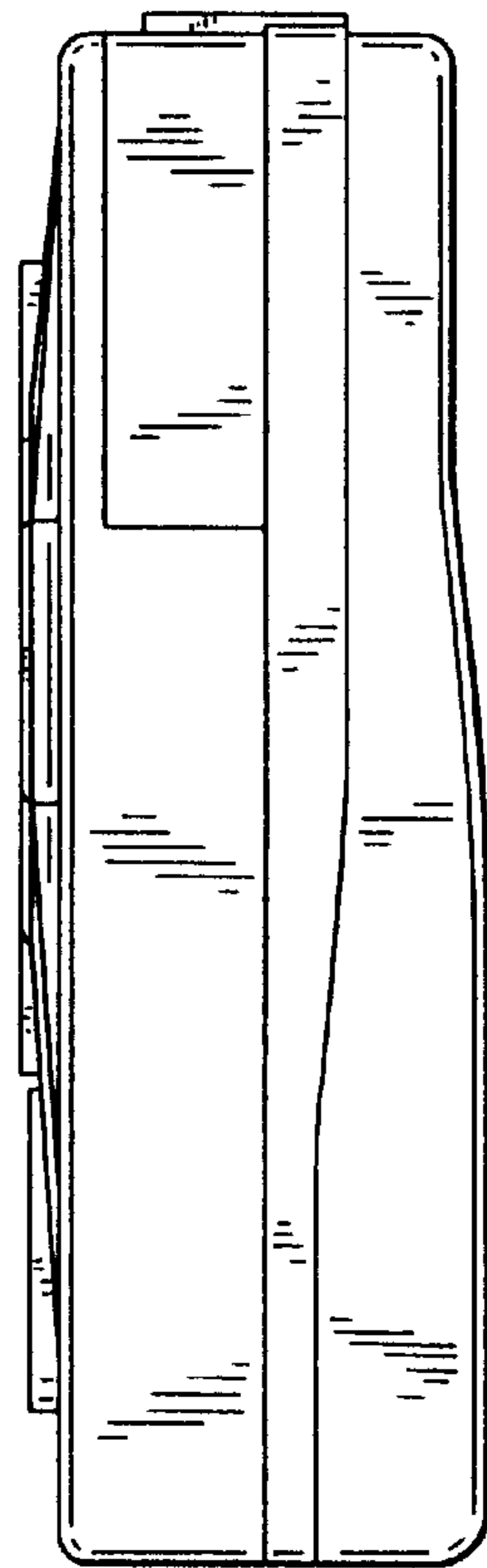

FIG. 8

