



US00D425860S

United States Patent [19] Goto

[11] **Patent Number: Des. 425,860**

[45] **Date of Patent: ** May 30, 2000**

[54] **ELECTRIC CONNECTOR**

DESCRIPTION

[75] Inventor: **Teiyo Goto**, Tokyo, Japan

[73] Assignee: **Sony Corporation**, Japan

[**] Term: **14 Years**

[21] Appl. No.: **29/099,572**

[22] Filed: **Jan. 21, 1999**

[51] **LOC (7) Cl.** **13-03**

[52] **U.S. Cl.** **D13/133; D13/153**

[58] **Field of Search** D13/146, 147,
D13/153; 439/607, 610, 680, 352, 358,
502

[56] **References Cited**

U.S. PATENT DOCUMENTS

D. 320,001	9/1991	Hirabayashi	D13/146
D. 325,191	4/1992	Shibano	D13/147
D. 366,242	1/1996	Goto	D13/147
D. 381,629	7/1997	Goto	D13/147
D. 395,036	6/1998	Goto	D13/147
3,792,284	2/1974	Kaelin	250/551
4,367,417	1/1983	Casasanta	307/147
4,954,101	9/1990	Nelson	439/502
4,990,103	2/1991	Sazaki et al.	439/455
5,267,882	12/1993	Davis	439/680
5,487,677	1/1996	Hoffner	439/293
5,580,268	12/1996	Miyazawa	439/352
5,931,690	8/1999	Sai et al.	439/350

Primary Examiner—Joel Sincavage

Attorney, Agent, or Firm—Rader, Fishman & Grauer

[57] **CLAIM**

The ornamental design for an electric connector, as shown and described.

FIG. 1 is a perspective view of a first embodiment of an electric connector showing my new design;

FIG. 2 is a top plan view thereof;

FIG. 3 is a left side elevational view thereof;

FIG. 4 is a front elevational view thereof;

FIG. 5 is a bottom plan view thereof;

FIG. 6 is a right side elevational view thereof; and

FIG. 7 is a rear elevational view thereof.

FIG. 8 is a perspective view of a second embodiment of an electric connector showing my new design;

FIG. 9 is a top plan view thereof;

FIG. 10 is a left side elevational view thereof;

FIG. 11 is a front elevational view thereof;

FIG. 12 is a bottom plan view thereof;

FIG. 13 is a right side elevational view thereof; and

FIG. 14 is a rear elevational view thereof.

FIG. 15 is a top, front, left perspective view of a third embodiment of an electric connector showing my new design;

FIG. 16 is a top, rear, right perspective view thereof;

FIG. 17 is a top plan view thereof;

FIG. 18 is a left side elevational view thereof;

FIG. 19 is a front elevational view thereof, a rear elevational view thereof being a mirror image;

FIG. 20 is a bottom plan view thereof; and,

FIG. 21 is a right side elevational view thereof.

The broken line showing of the cable in FIGS. 1-7 is included for the purpose of illustrating environmental structure only and forms no part of the first embodiment. In FIGS. 8-14, the cable is shown broken away to indicate indeterminate length.

1 Claim, 6 Drawing Sheets

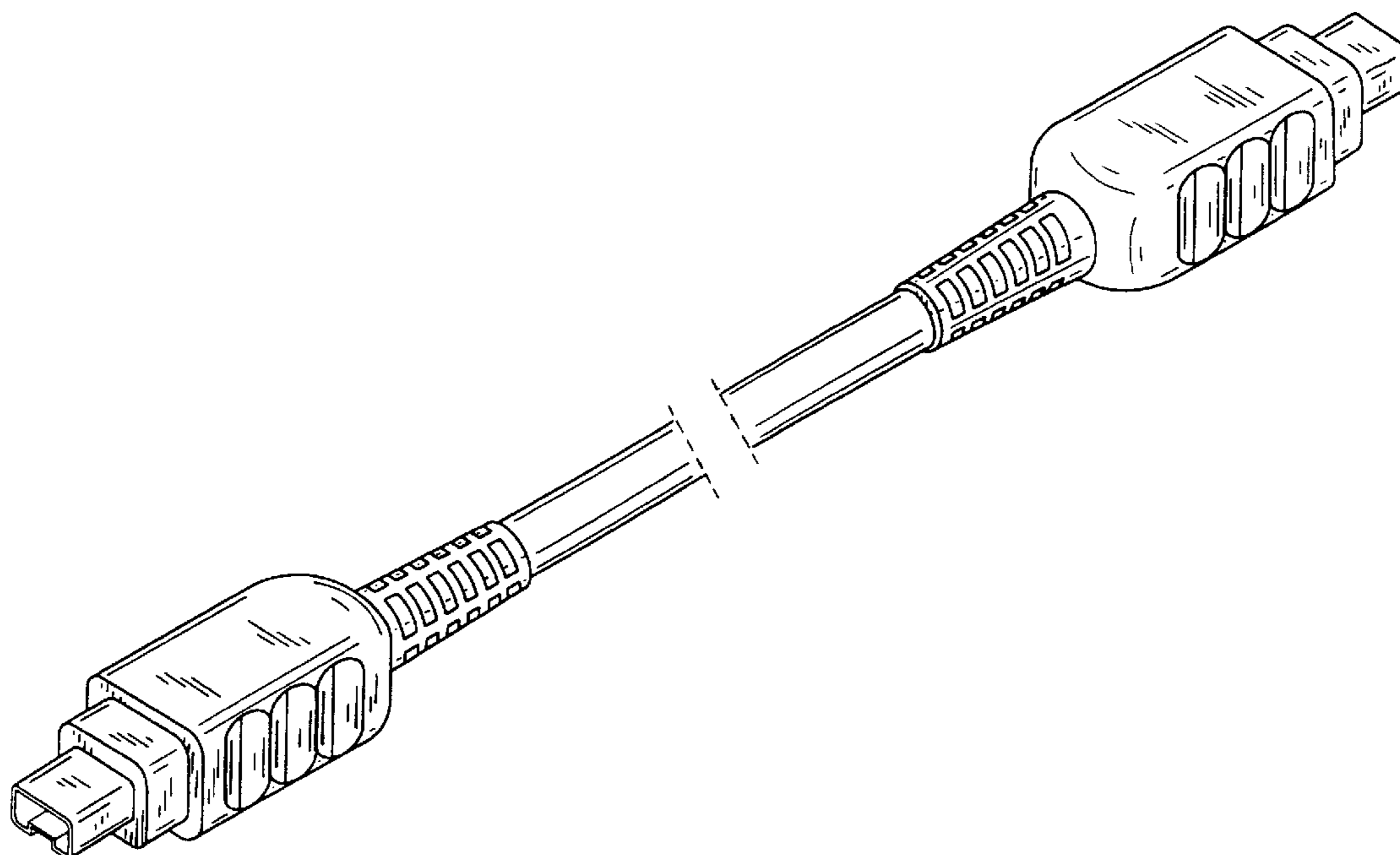

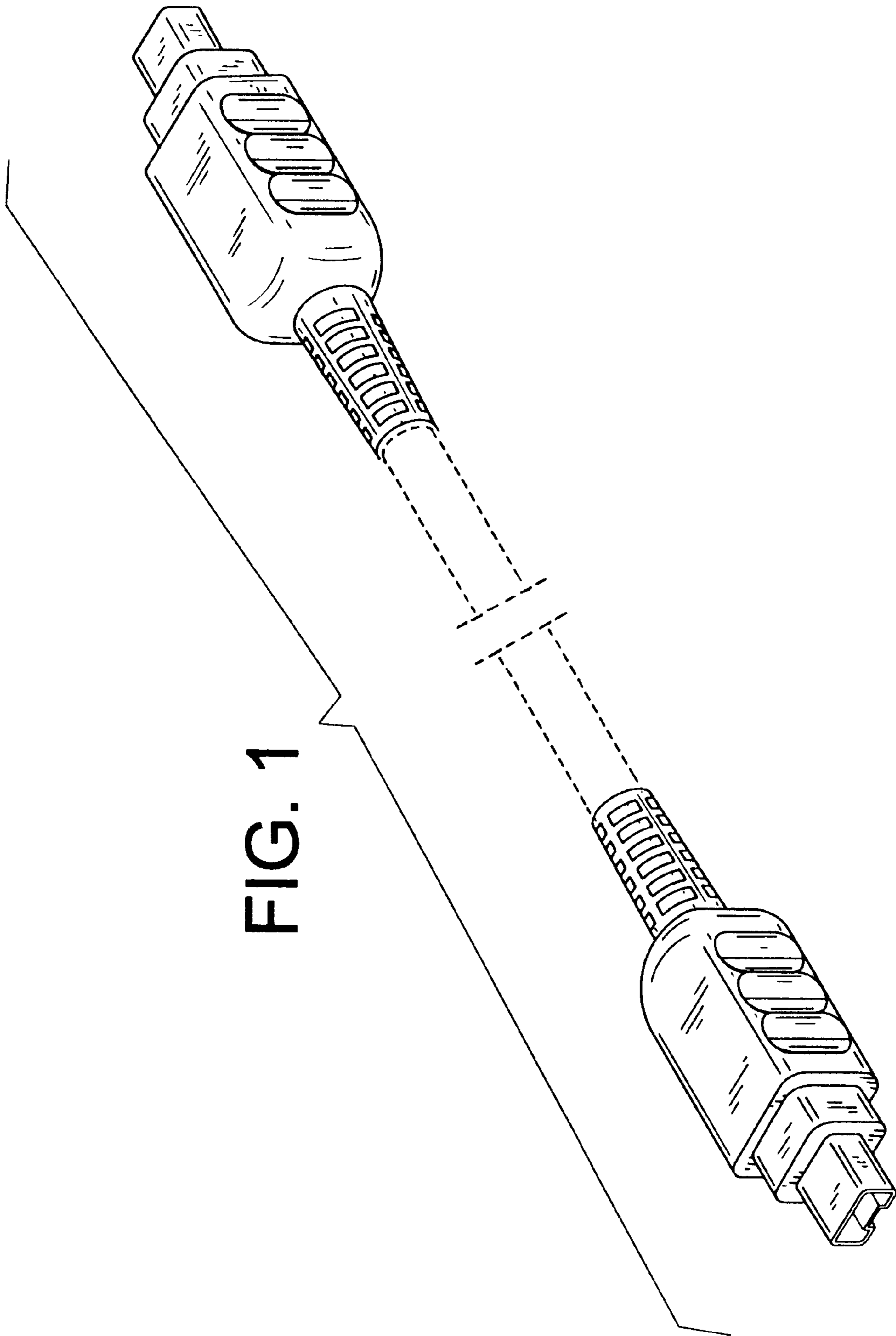

FIG. 1

FIG. 2

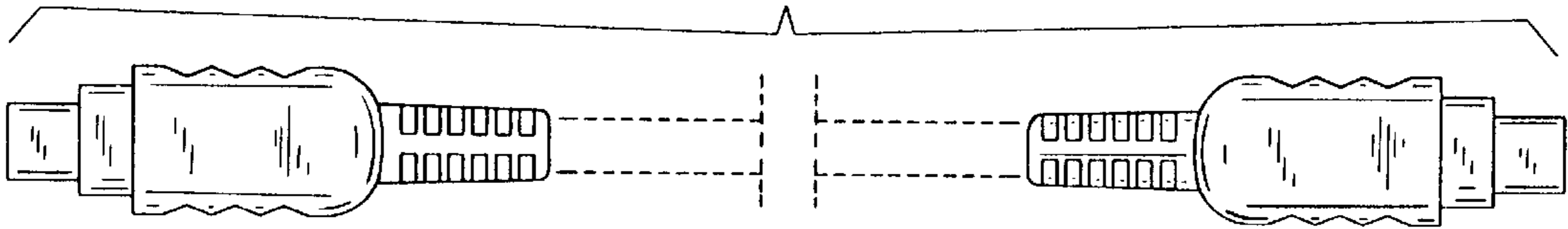

FIG. 3

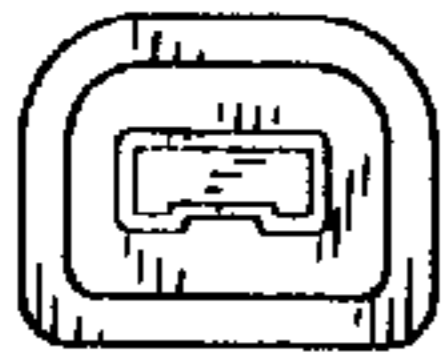

FIG. 6



FIG. 4

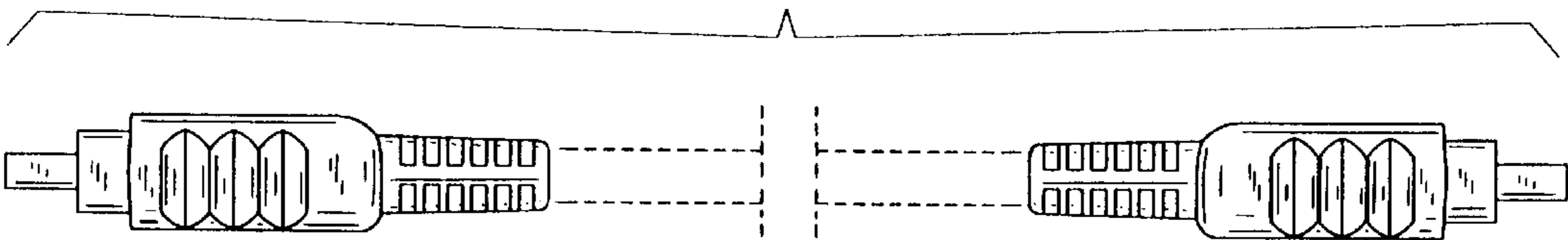

FIG. 5

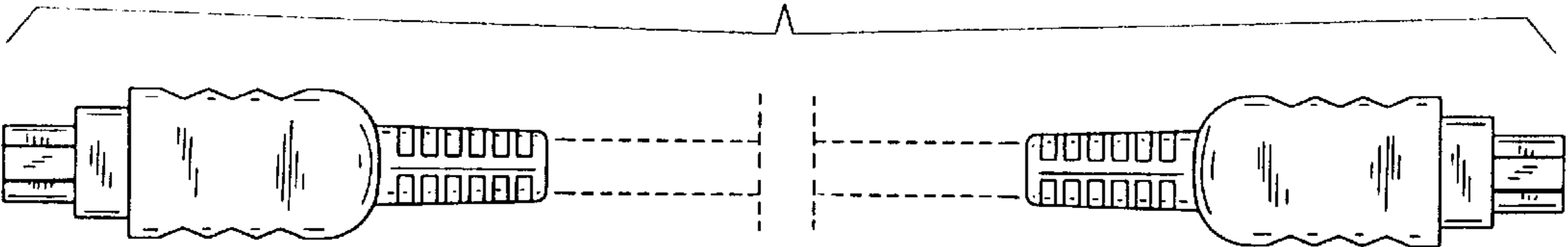
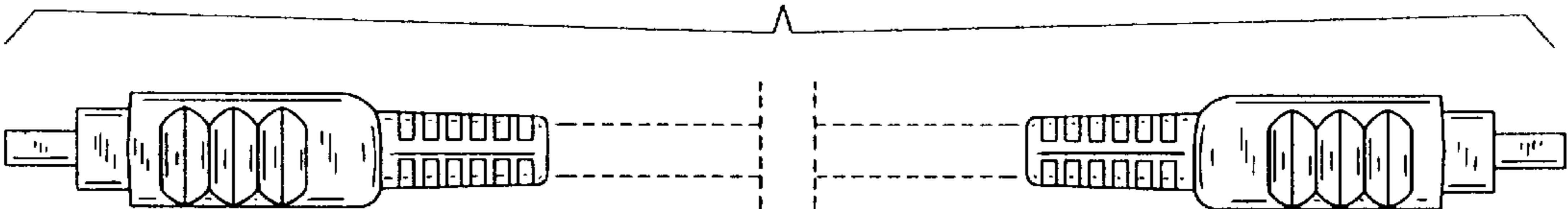

FIG. 7



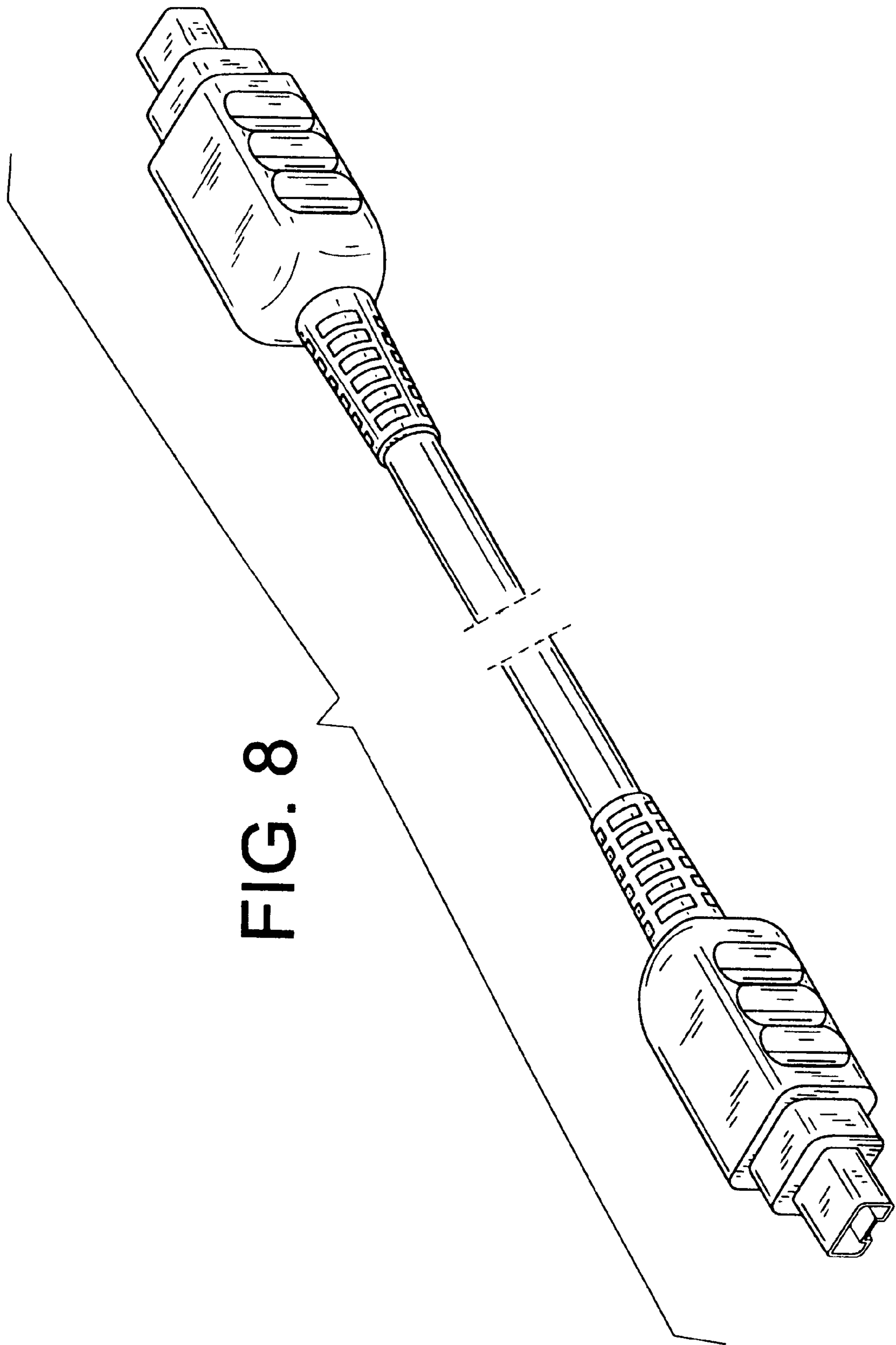

FIG. 8

FIG. 9

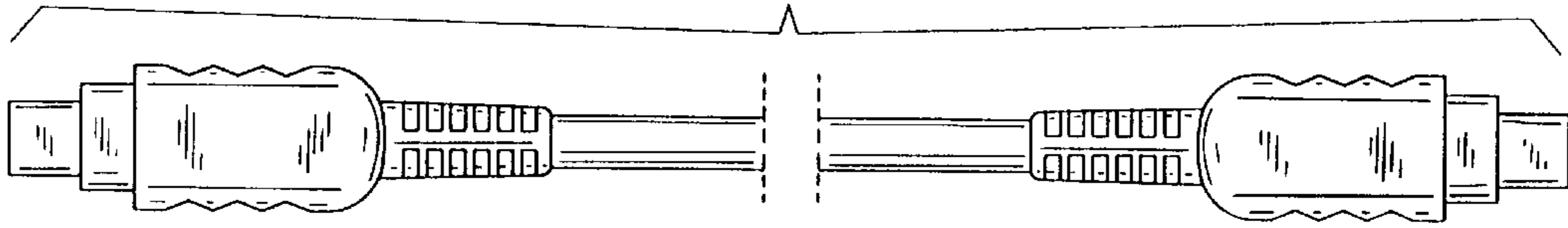

FIG. 10

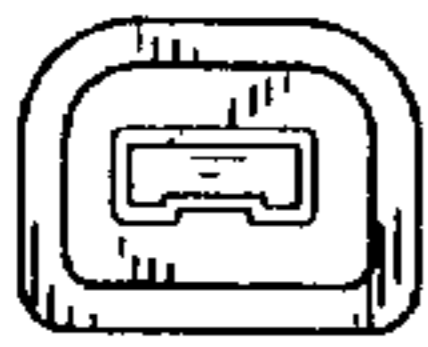

FIG. 13

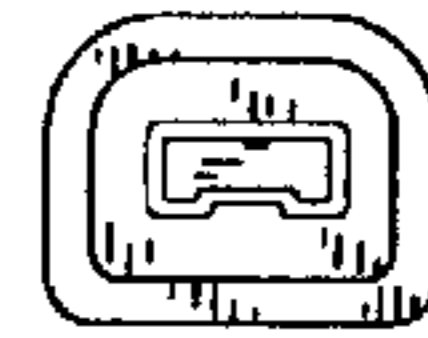

FIG. 11

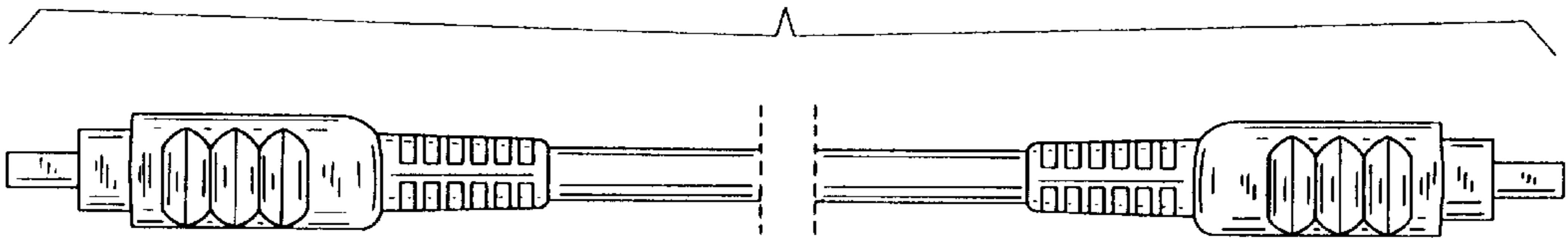

FIG. 12

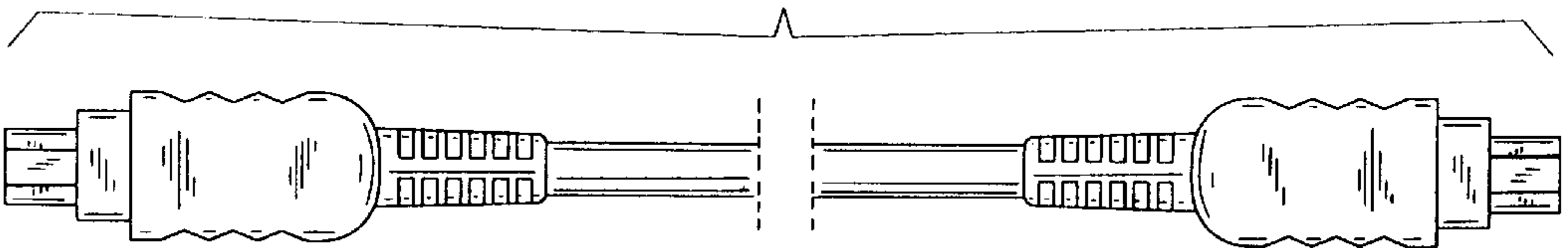

FIG. 14

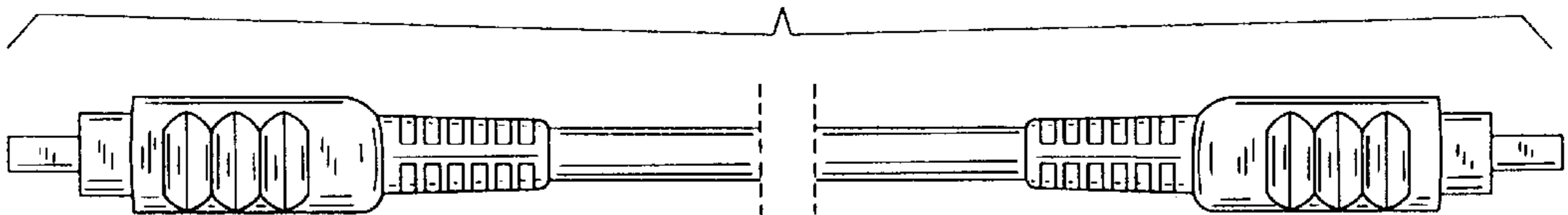

FIG. 16

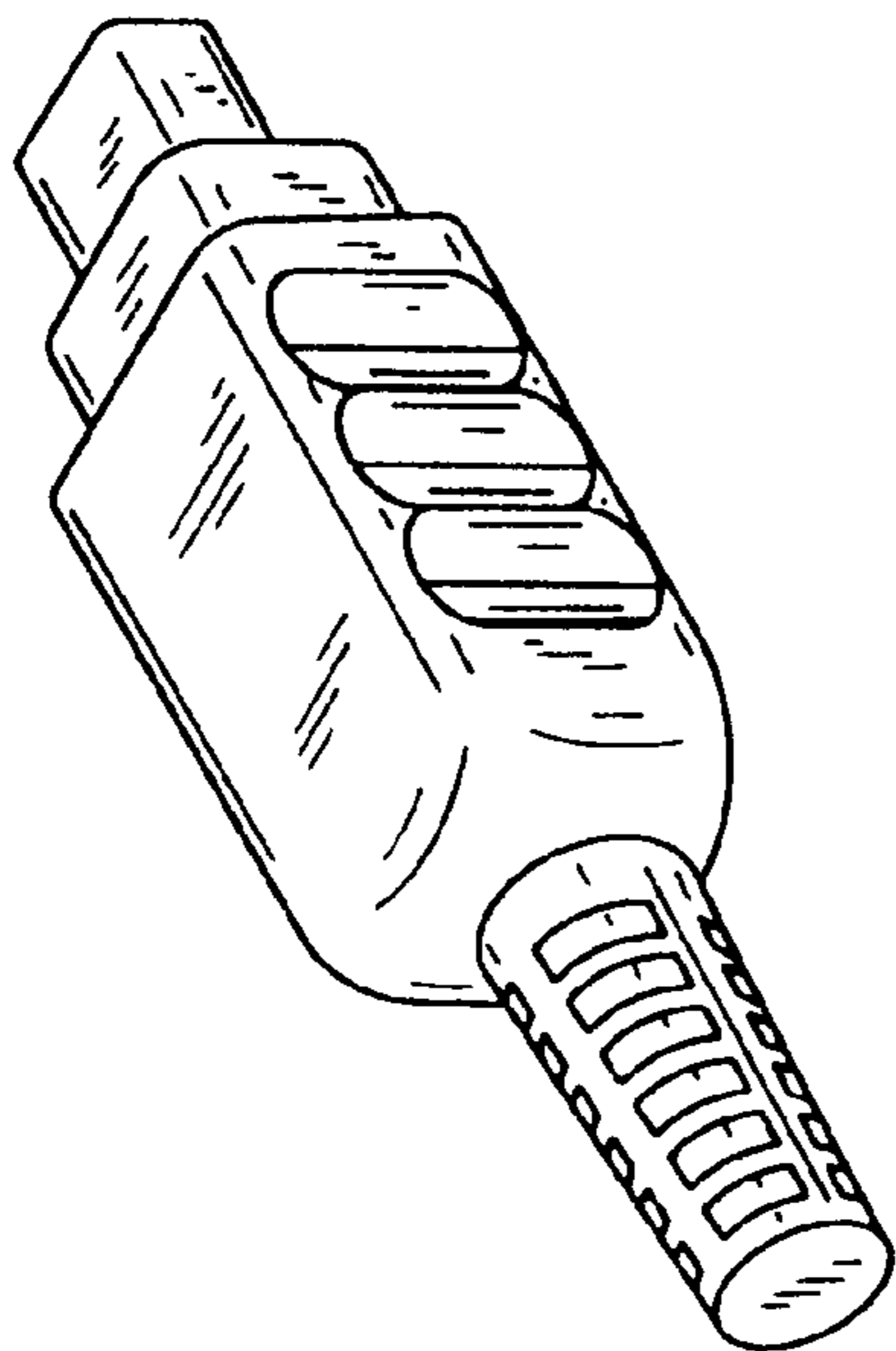

FIG. 15

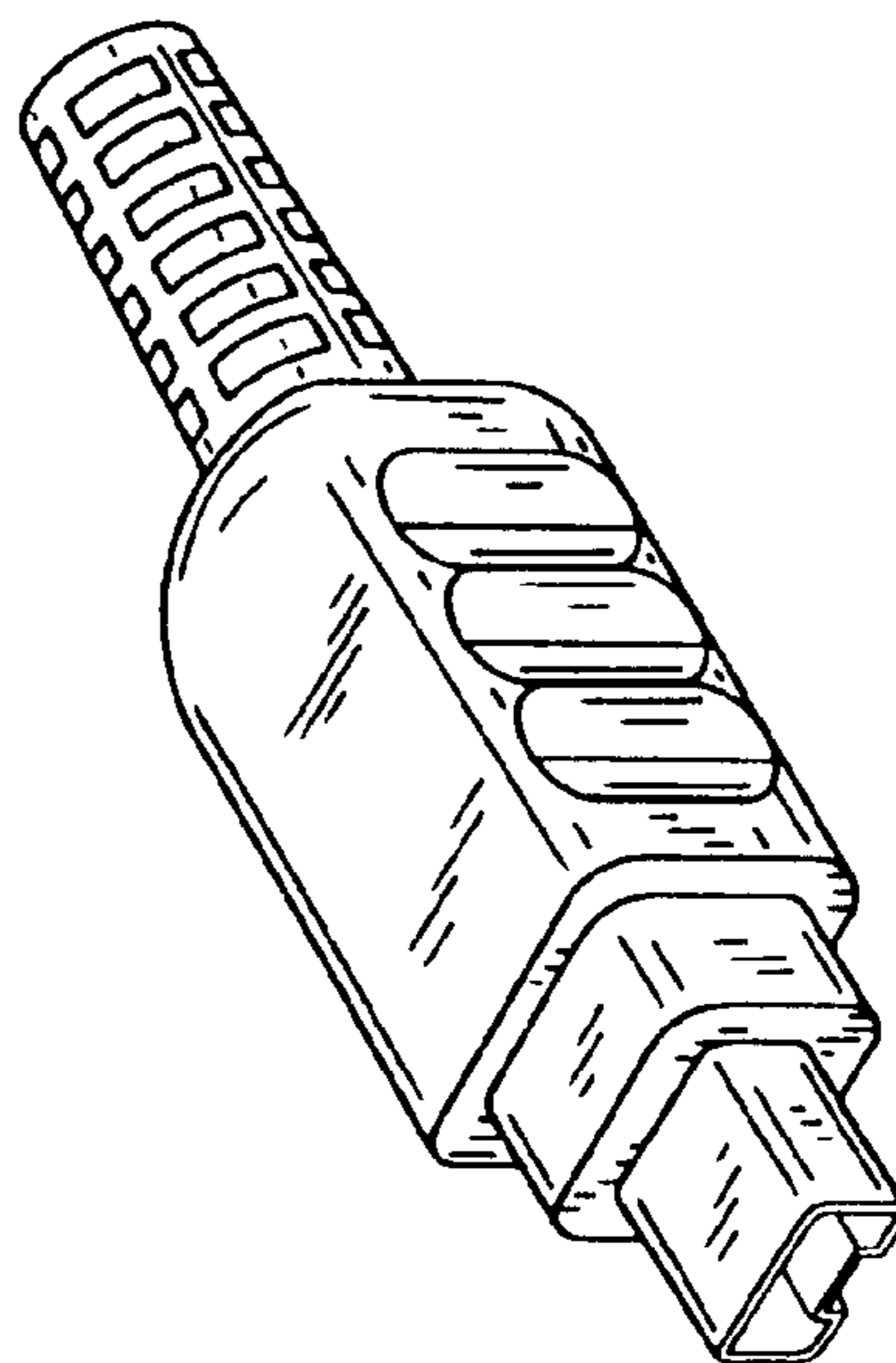

FIG. 17

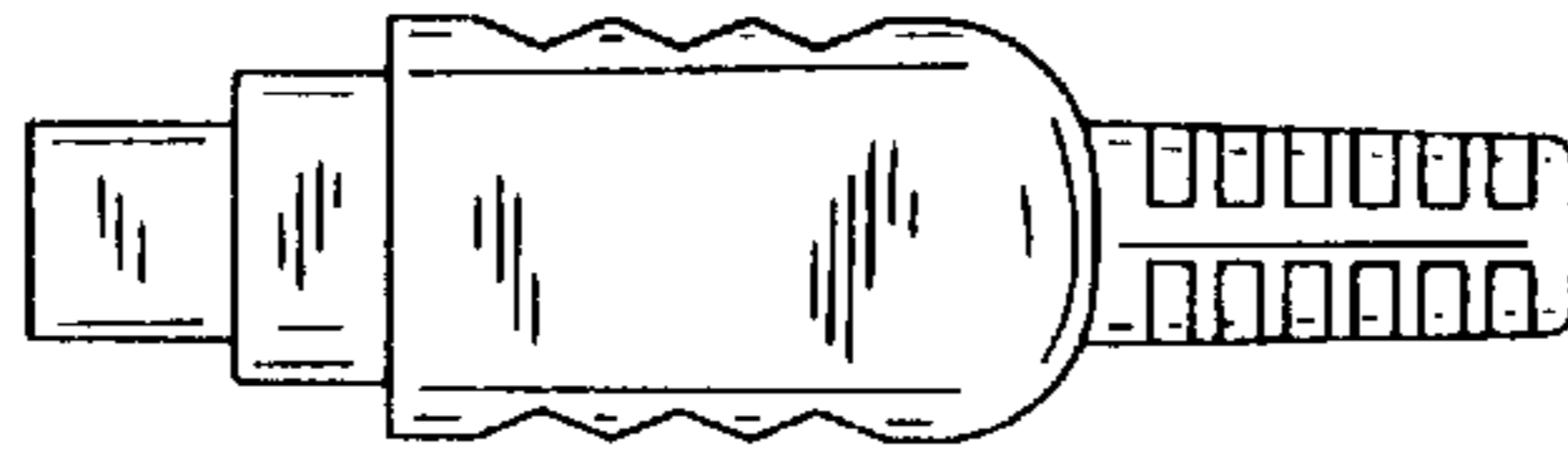

FIG. 18

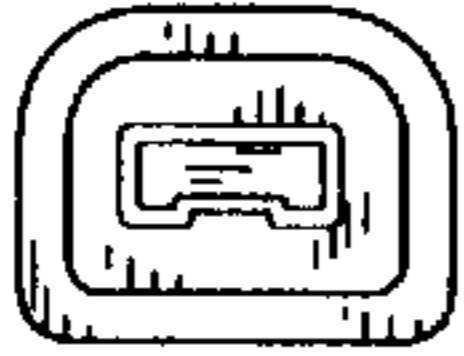

FIG. 19

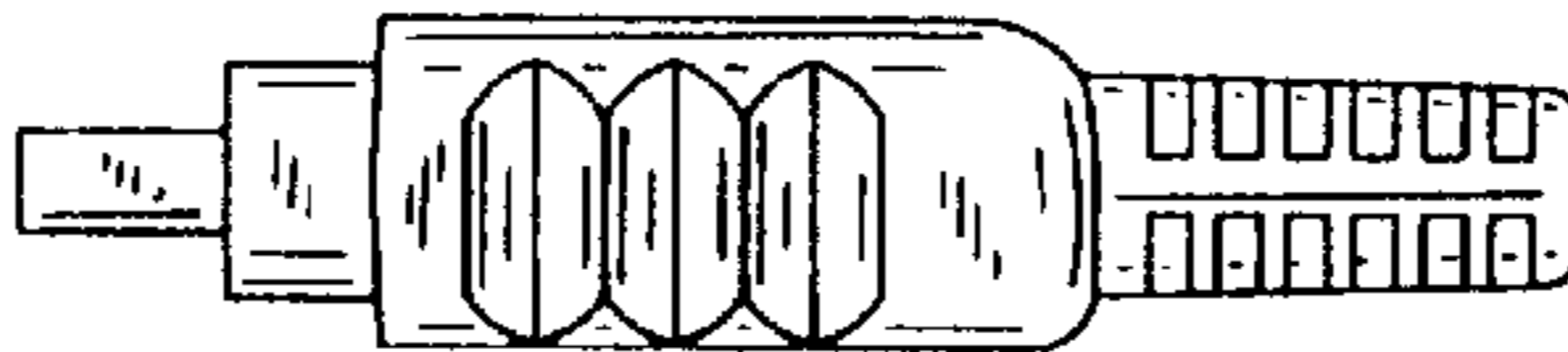

FIG. 21



FIG. 20

