



US00D425856S

United States Patent [19] Shindo

[11] **Patent Number: Des. 425,856**

[45] **Date of Patent: ** May 30, 2000**

[54] **CHARGER FOR WIRELESS TELEPHONE**

D. 410,922 6/1999 Komiyama D14/149

[75] Inventor: **Koji Shindo**, Tokyo, Japan

OTHER PUBLICATIONS

[73] Assignee: **Sony Corporation**, Tokyo, Japan

Sony Style, vol. 6, p. 175, Fall/Winter, Sep. 1996.
Sony Style, p. 267, SPP-ID400, Apr. 1998.

[**] Term: **14 Years**

Primary Examiner—Jeffrey Asch
Attorney, Agent, or Firm—Foley & Lardner

[21] Appl. No.: **29/084,310**

[22] Filed: **Feb. 27, 1998**

[57] CLAIM

[51] **LOC (7) Cl.** **13-02**

The ornamental design for a charger for a wireless telephone, as shown and described.

[52] **U.S. Cl.** **D13/108**; D14/149

DESCRIPTION

[58] **Field of Search** D14/137, 138,
D14/148, 147, 149–151, 140–142, 240,
241, 251, 253; 379/433–436, 419, 420,
428, 440, 454, 455, 446, 447; D13/107,
108; 320/110, 113, 114, 115

FIG. 1 is a perspective view of a first embodiment of a charger for wireless telephone showing my new design; FIG. 2 is a top plan view thereof; FIG. 3 is a rear elevational view thereof; FIG. 4 is a right side elevational view thereof; FIG. 5 is a front elevational view thereof; FIG. 6 is a bottom plan view thereof; and FIG. 7 is a left side elevational view thereof.

[56] References Cited

U.S. PATENT DOCUMENTS

D. 274,244	6/1984	Kim	D14/138
D. 307,276	4/1990	Desbarats	D14/149
D. 349,899	8/1994	Siddoway et al.	D13/108 X
D. 351,164	10/1994	Siddoway et al.	D14/149
D. 352,497	11/1994	Scianna, Sr. et al.	D13/108
D. 355,652	2/1995	Lee et al.	D14/149
D. 359,284	6/1995	Hung	D14/151
D. 369,499	5/1996	Kong et al.	D14/149
D. 369,600	5/1996	Zeitman	D14/144
D. 369,798	5/1996	Kong et al.	D14/149
D. 371,129	6/1996	Kong et al.	D14/149
D. 401,235	11/1998	Fuke et al.	D14/149

FIG. 8 is a perspective view of a second embodiment of a charger for wireless telephone showing my new design; FIG. 9 is a top plan view thereof; FIG. 10 is a rear elevational view thereof; FIG. 11 is a right side elevational view thereof; FIG. 12 is a front elevational plan view thereof; FIG. 13 is a bottom plan view thereof; and, FIG. 14 is a left side elevational view thereof.

1 Claim, 8 Drawing Sheets

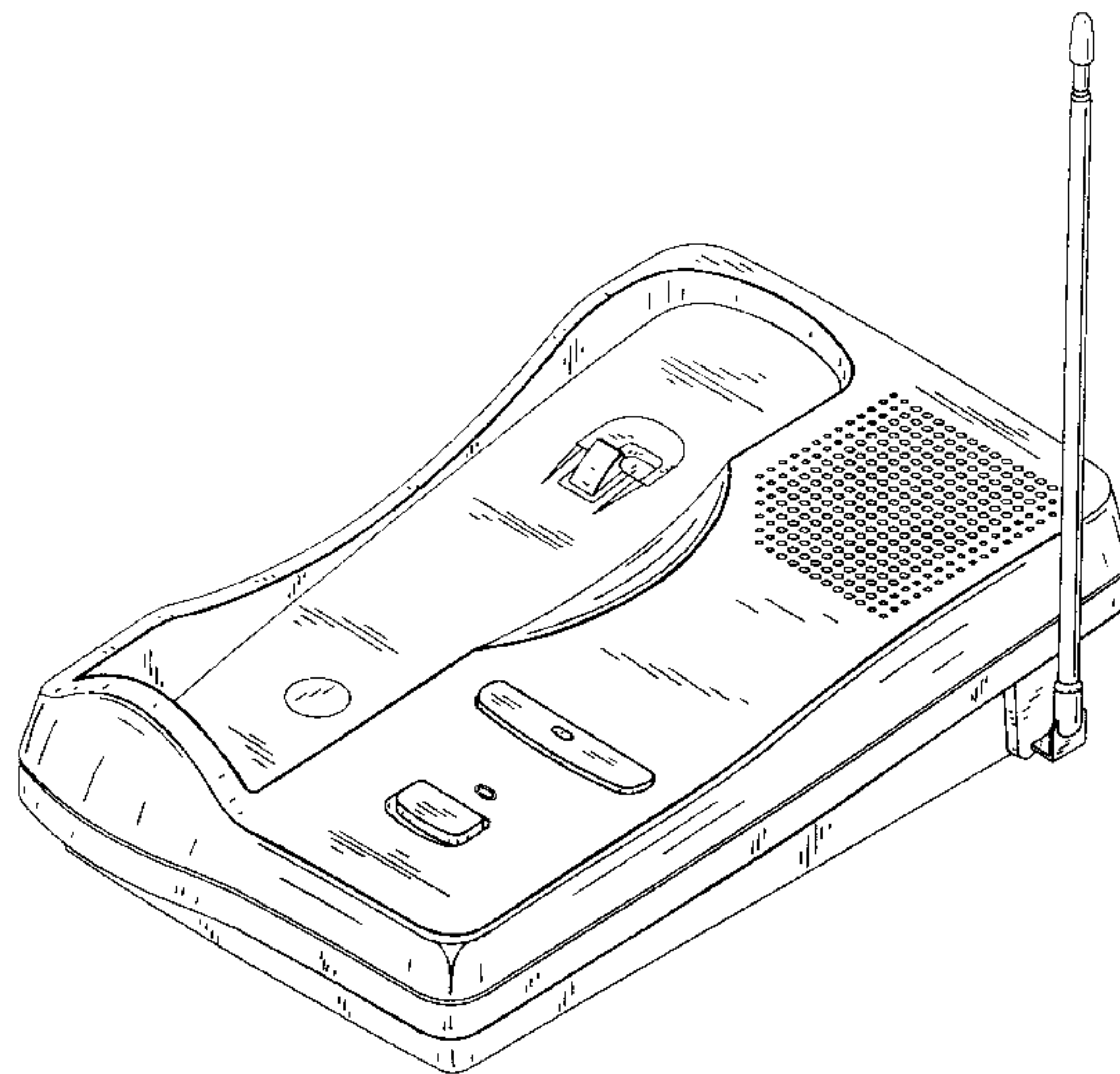
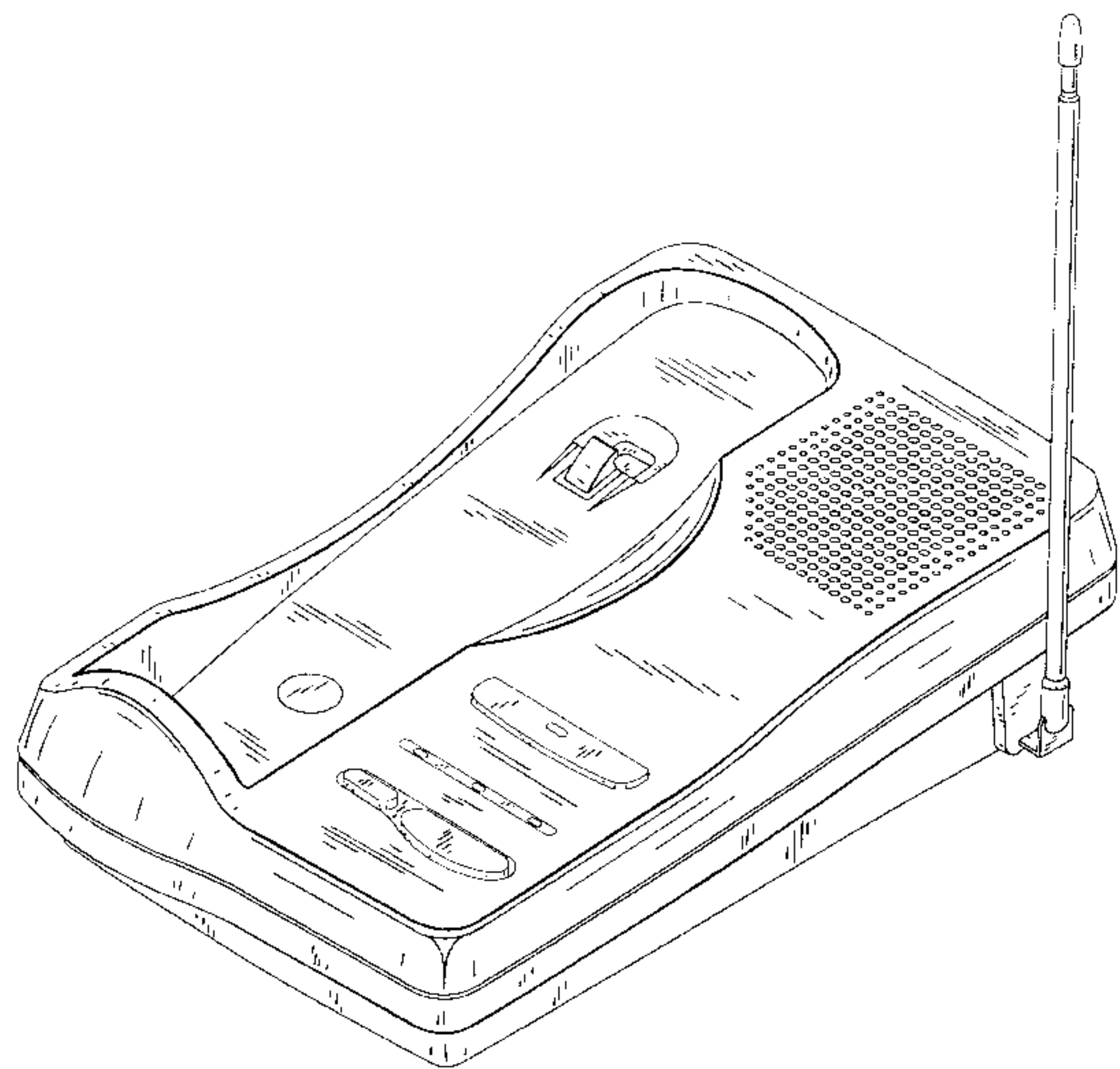

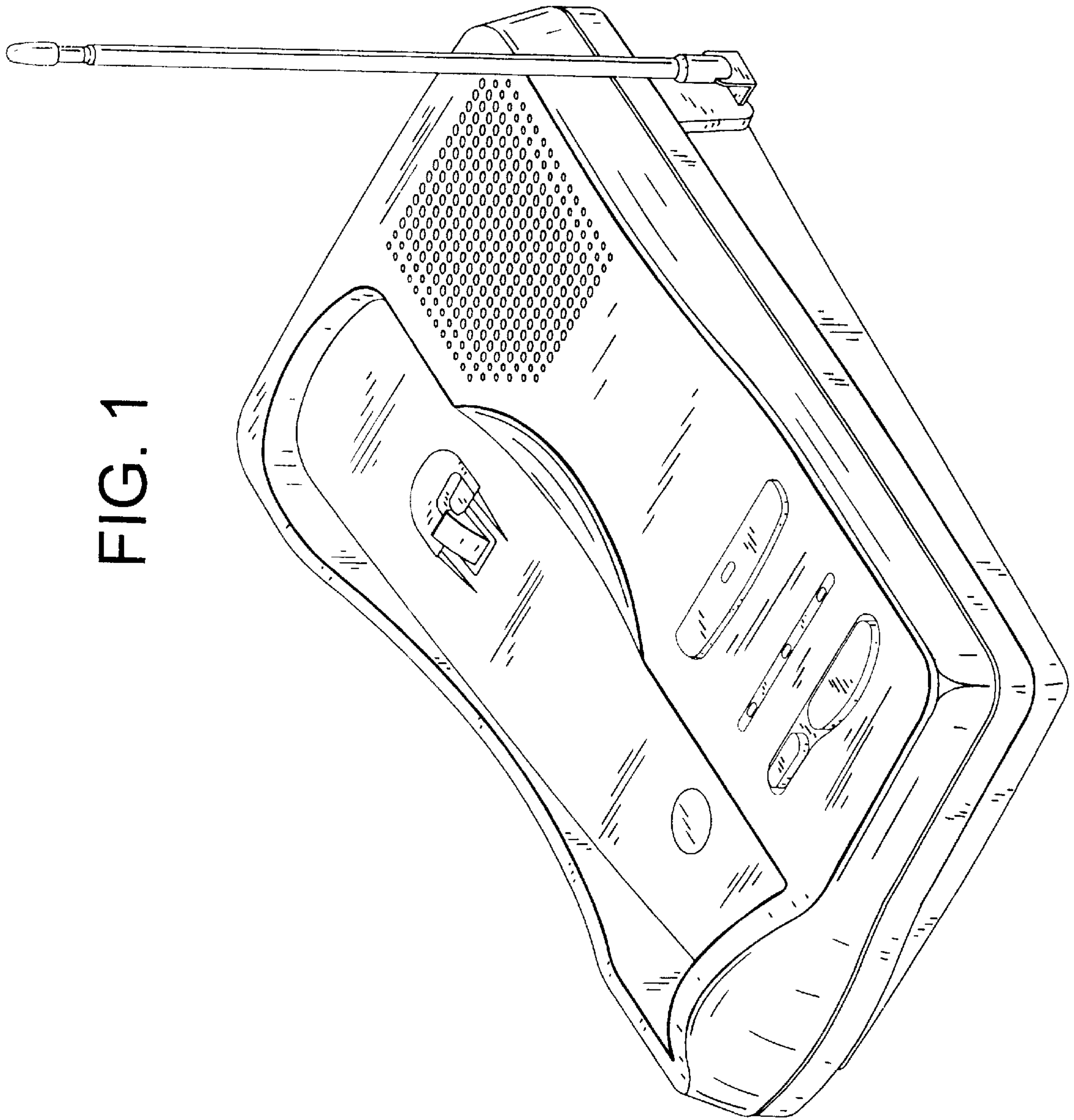

FIG. 1

FIG. 2

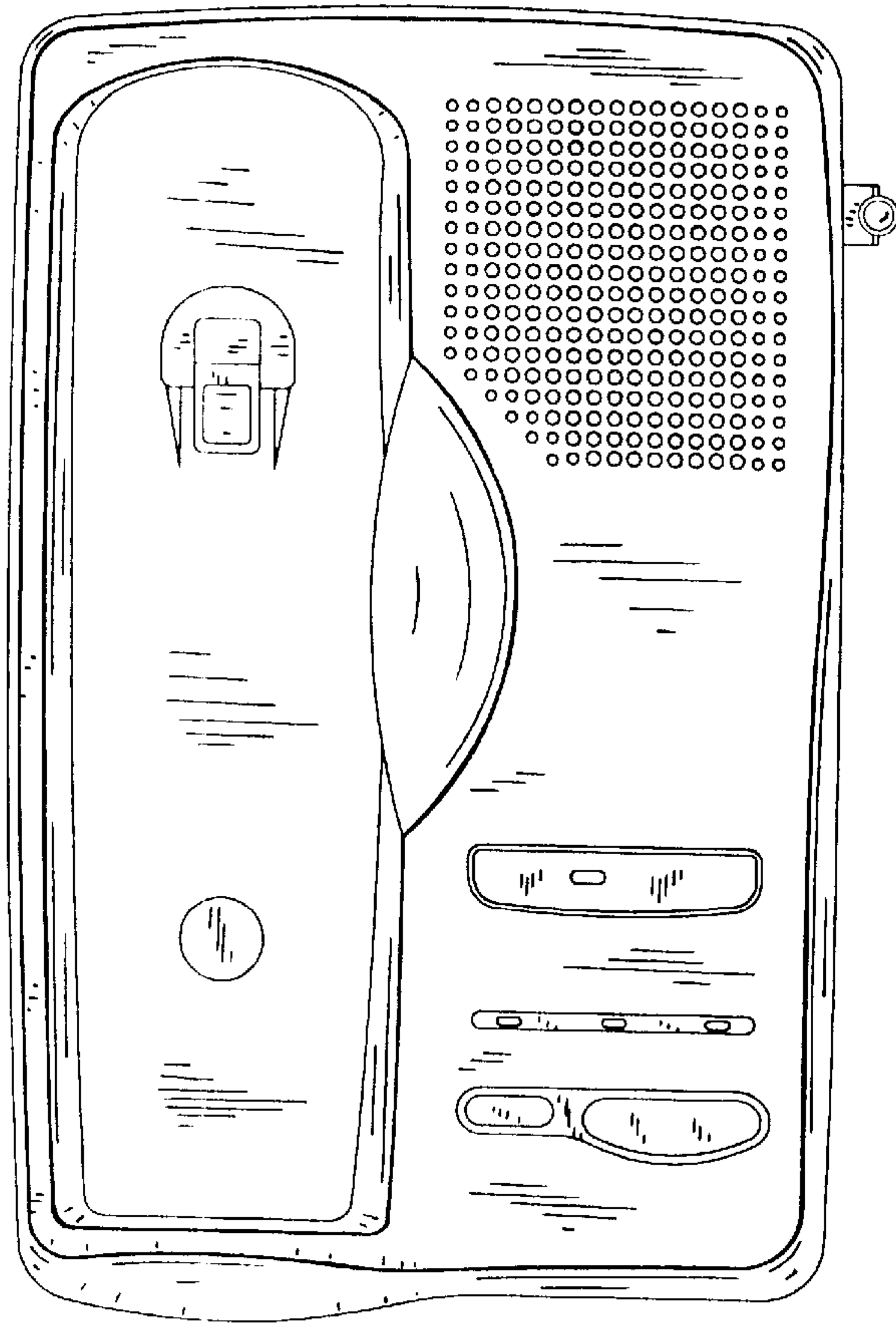

FIG. 3

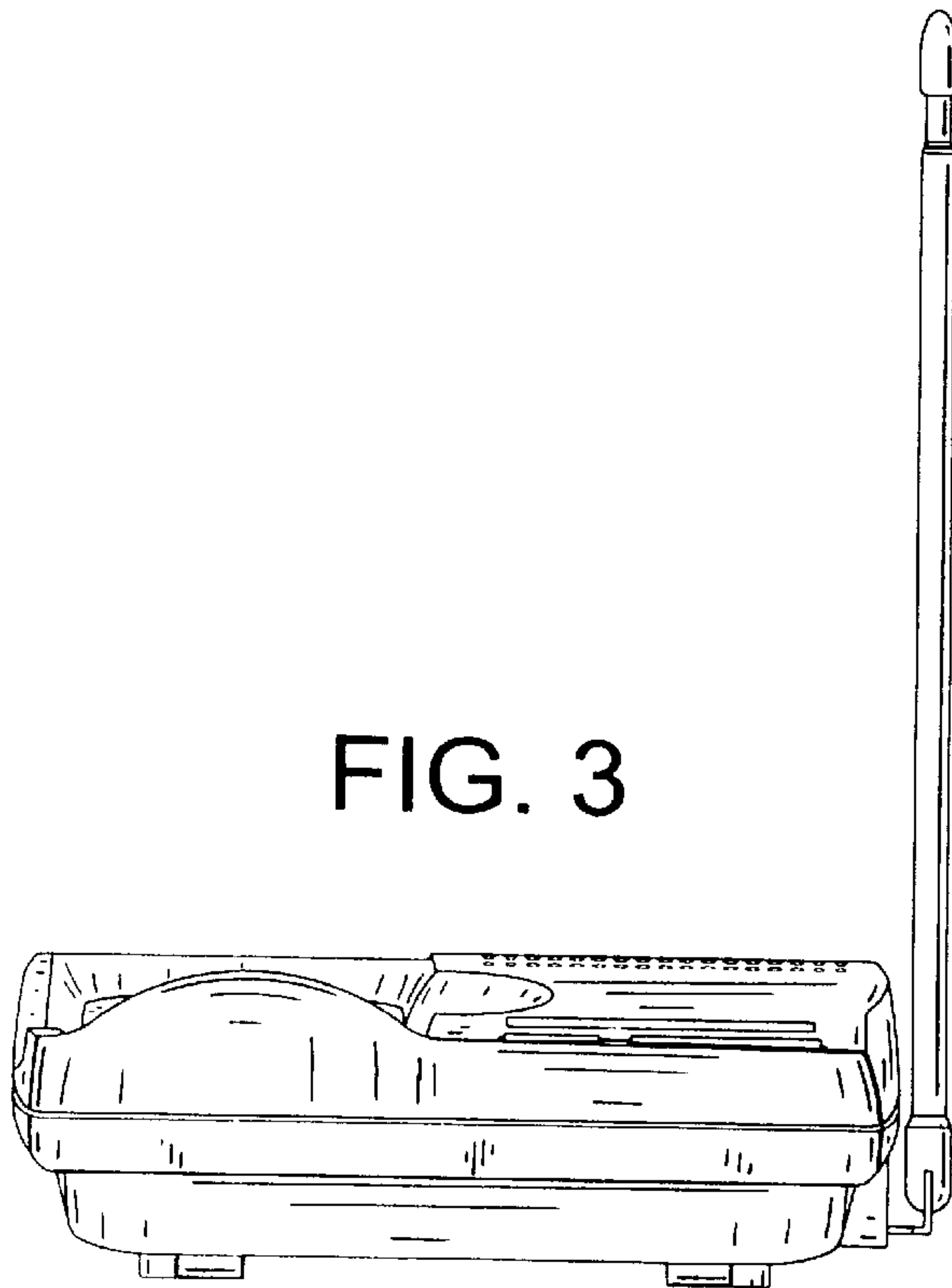

FIG. 4

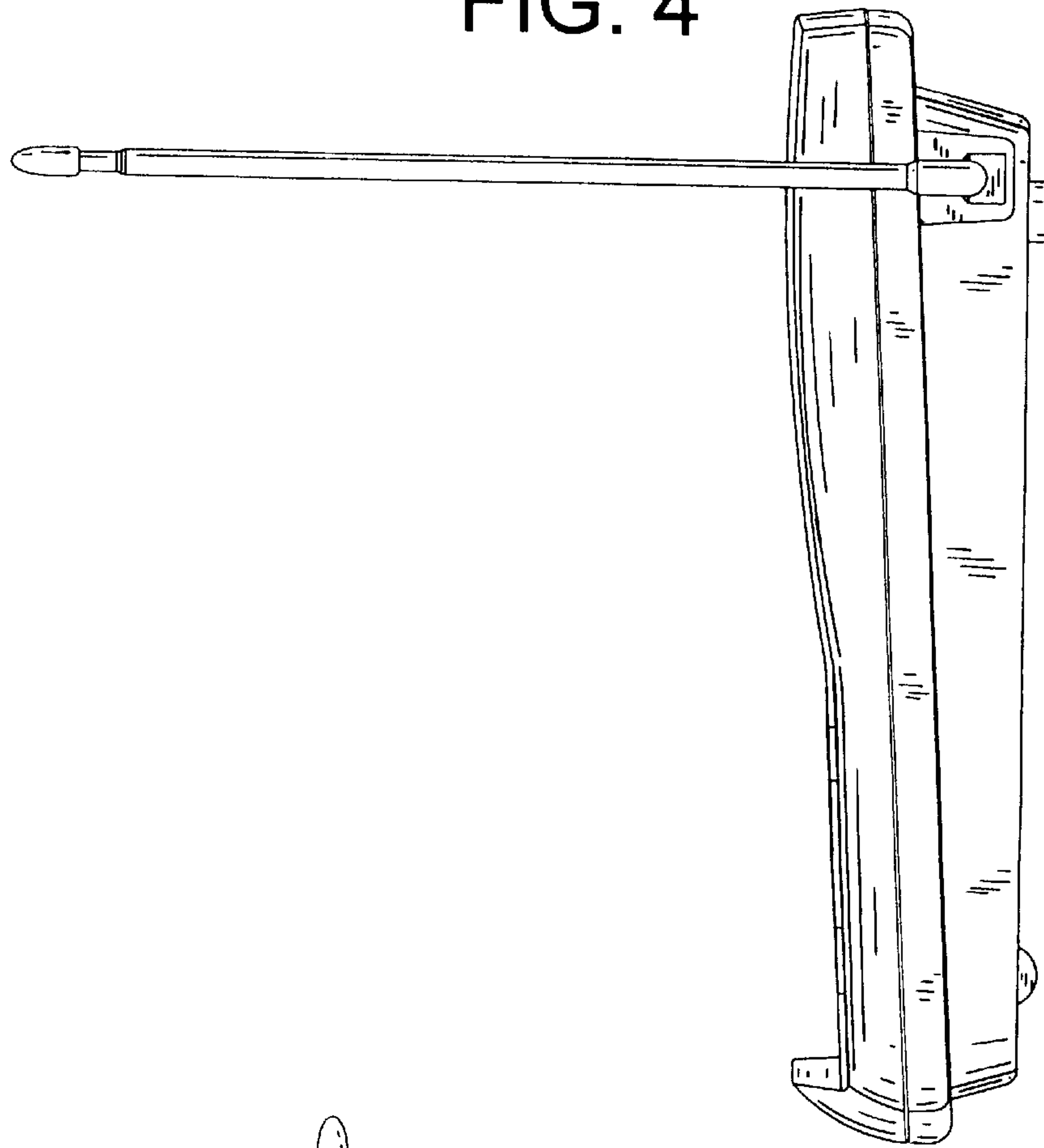

FIG. 5

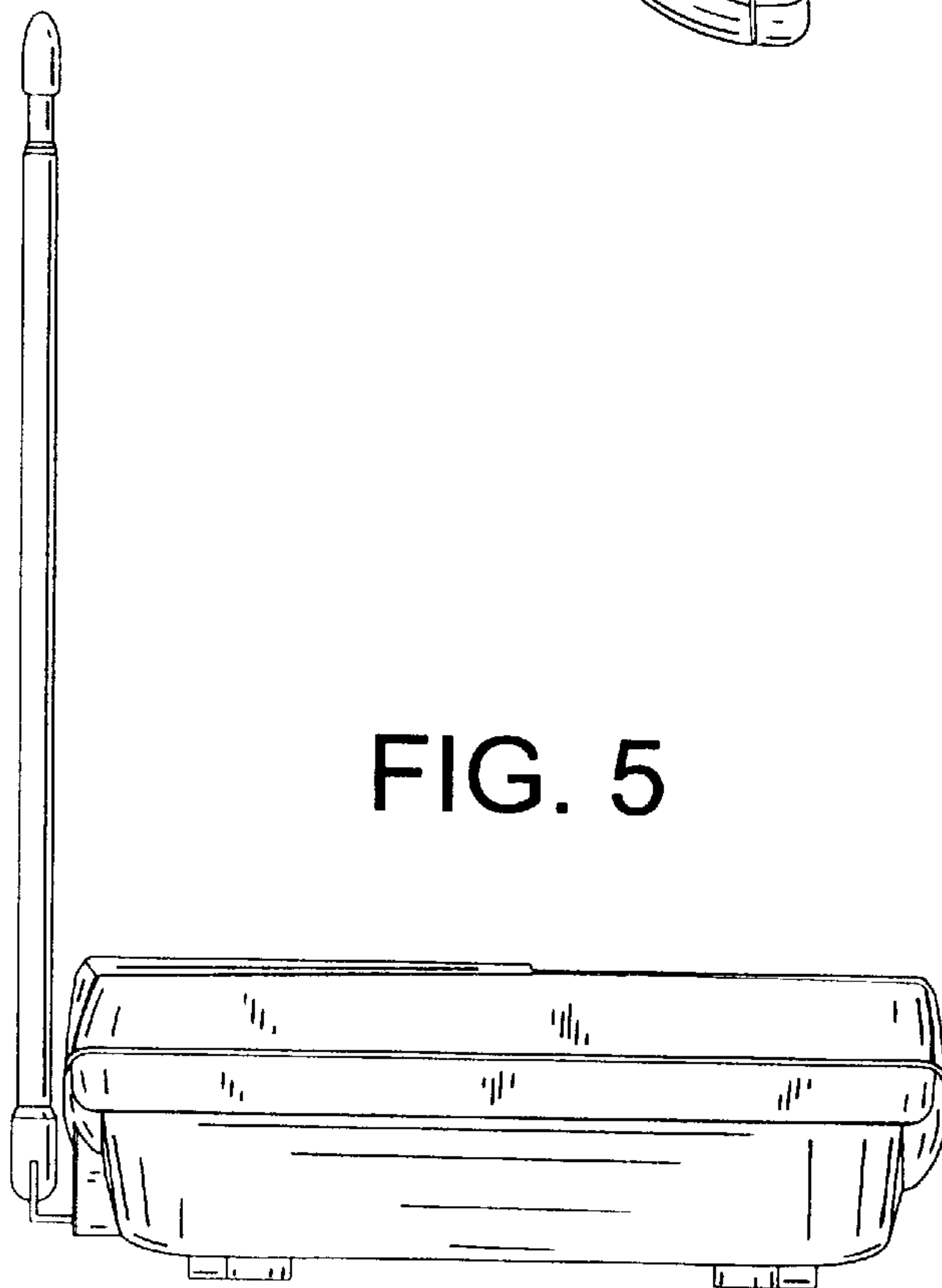

FIG. 7

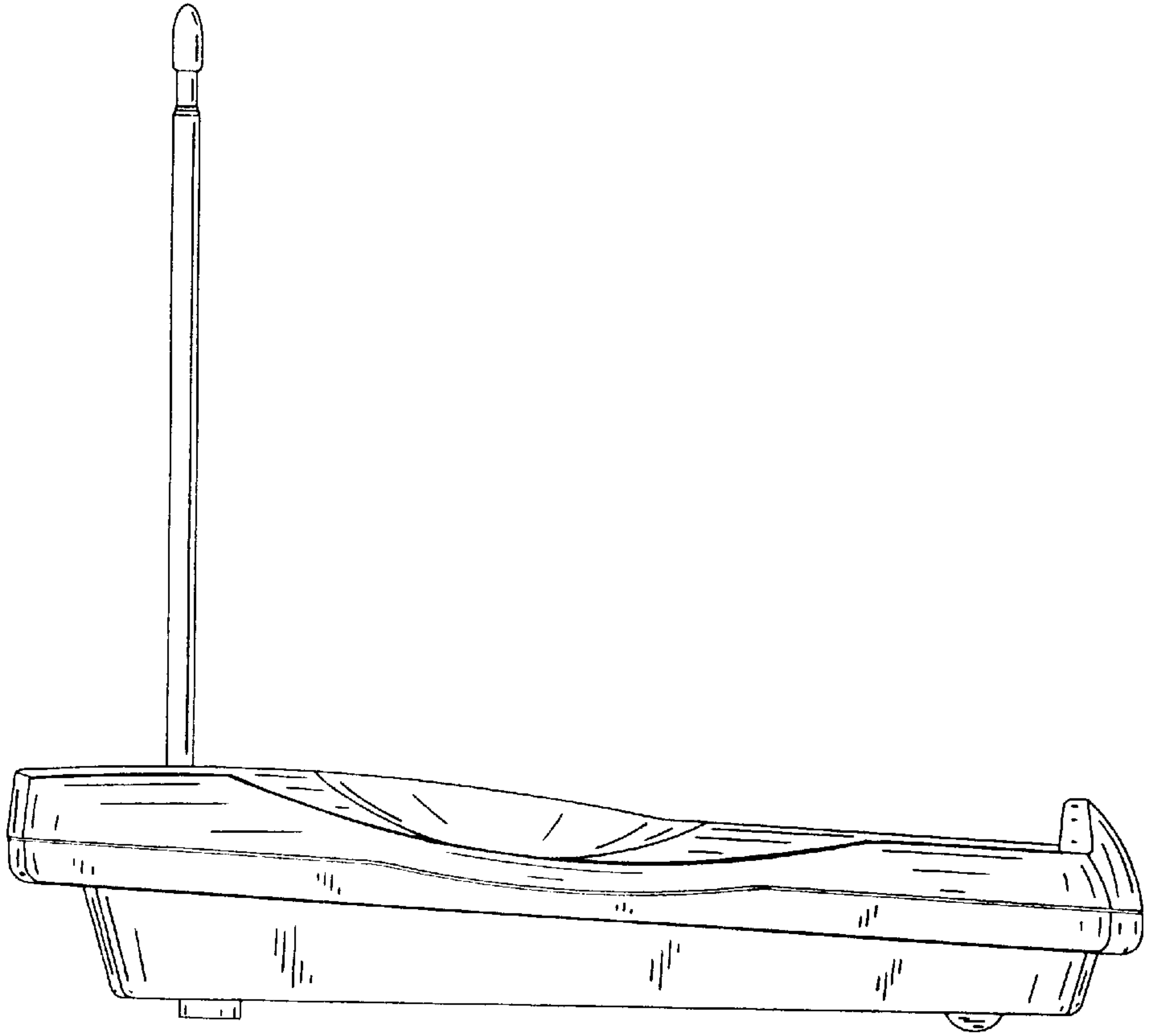

FIG. 6

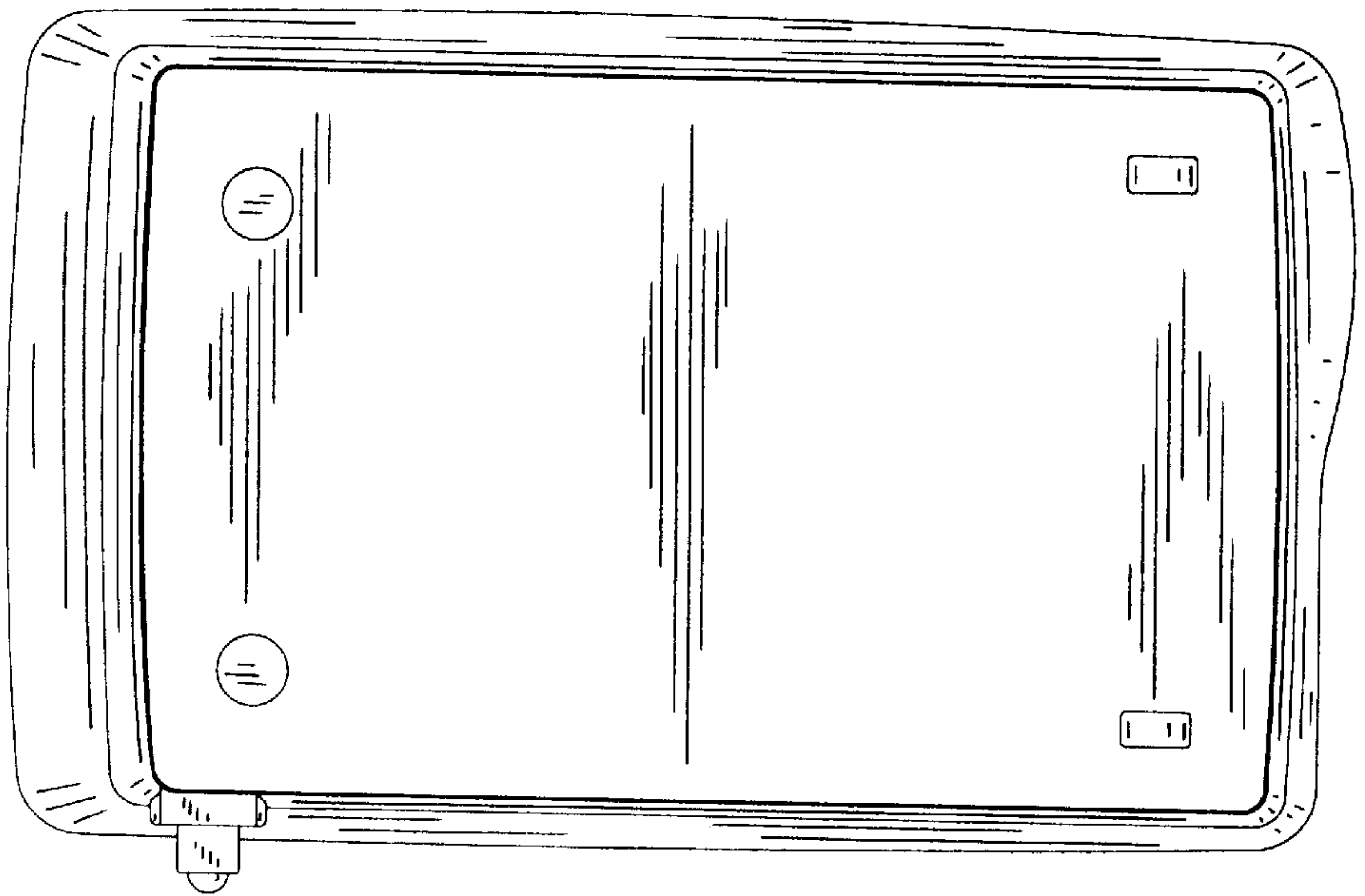

FIG. 8

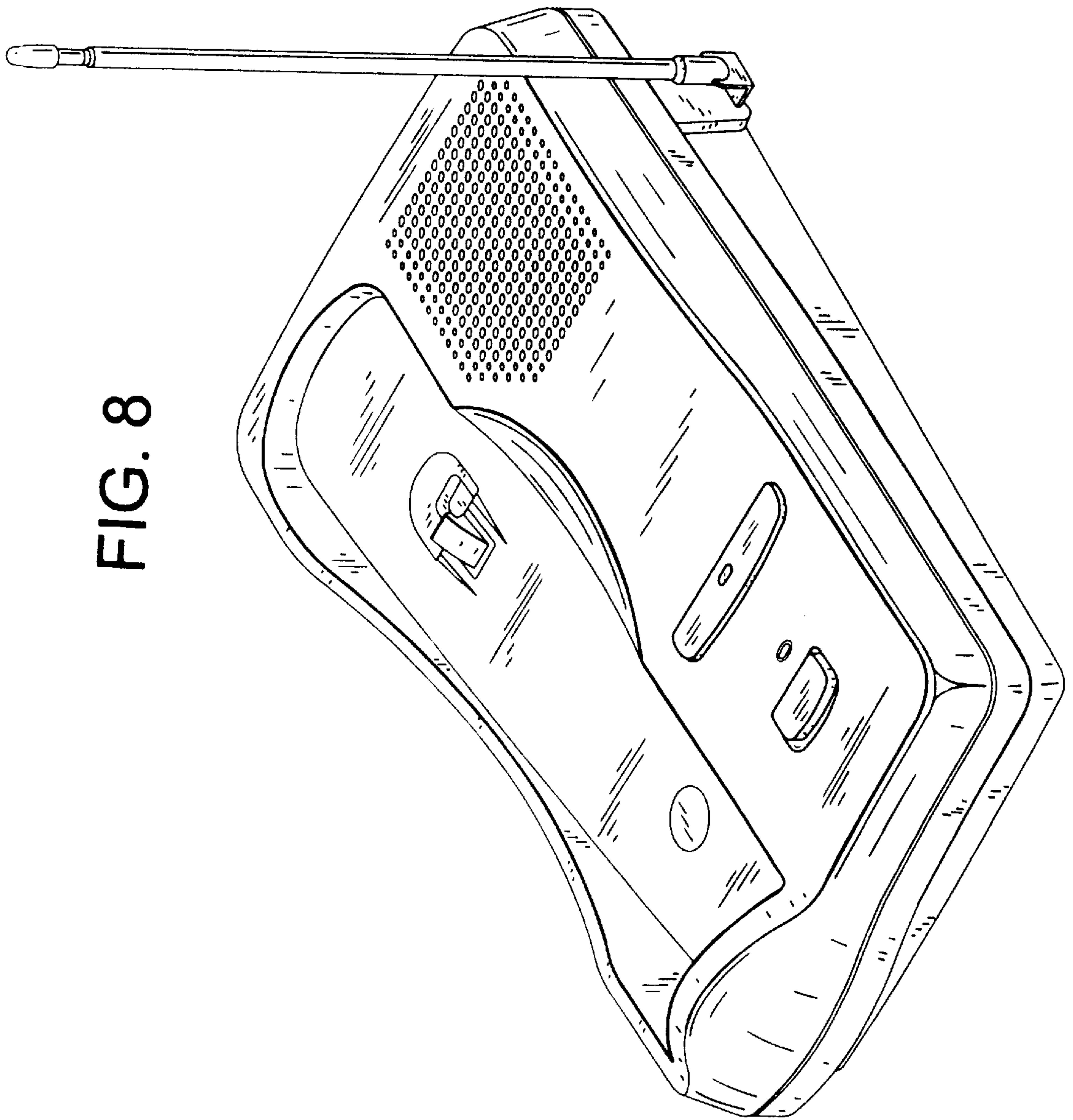

FIG. 9

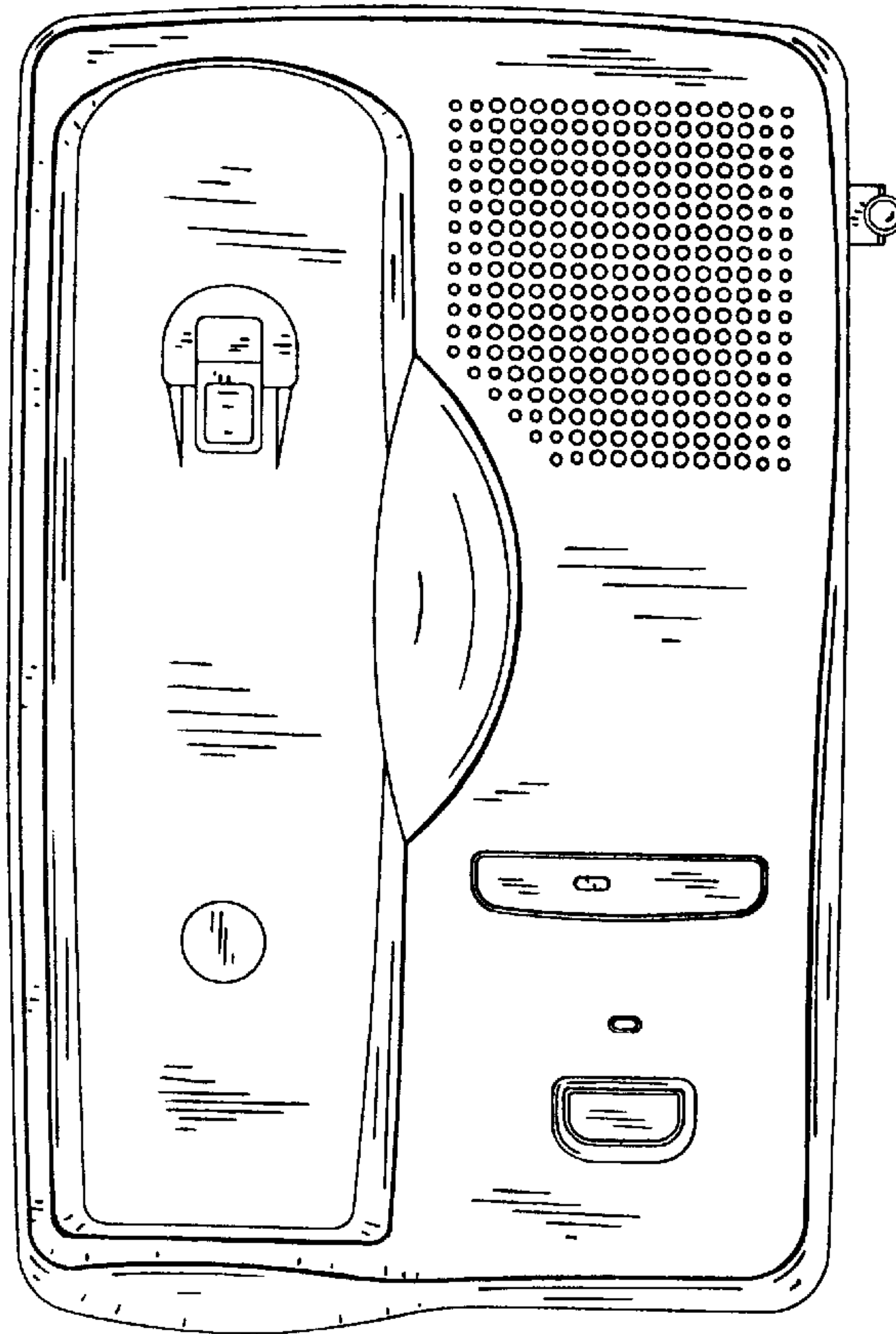

FIG. 10

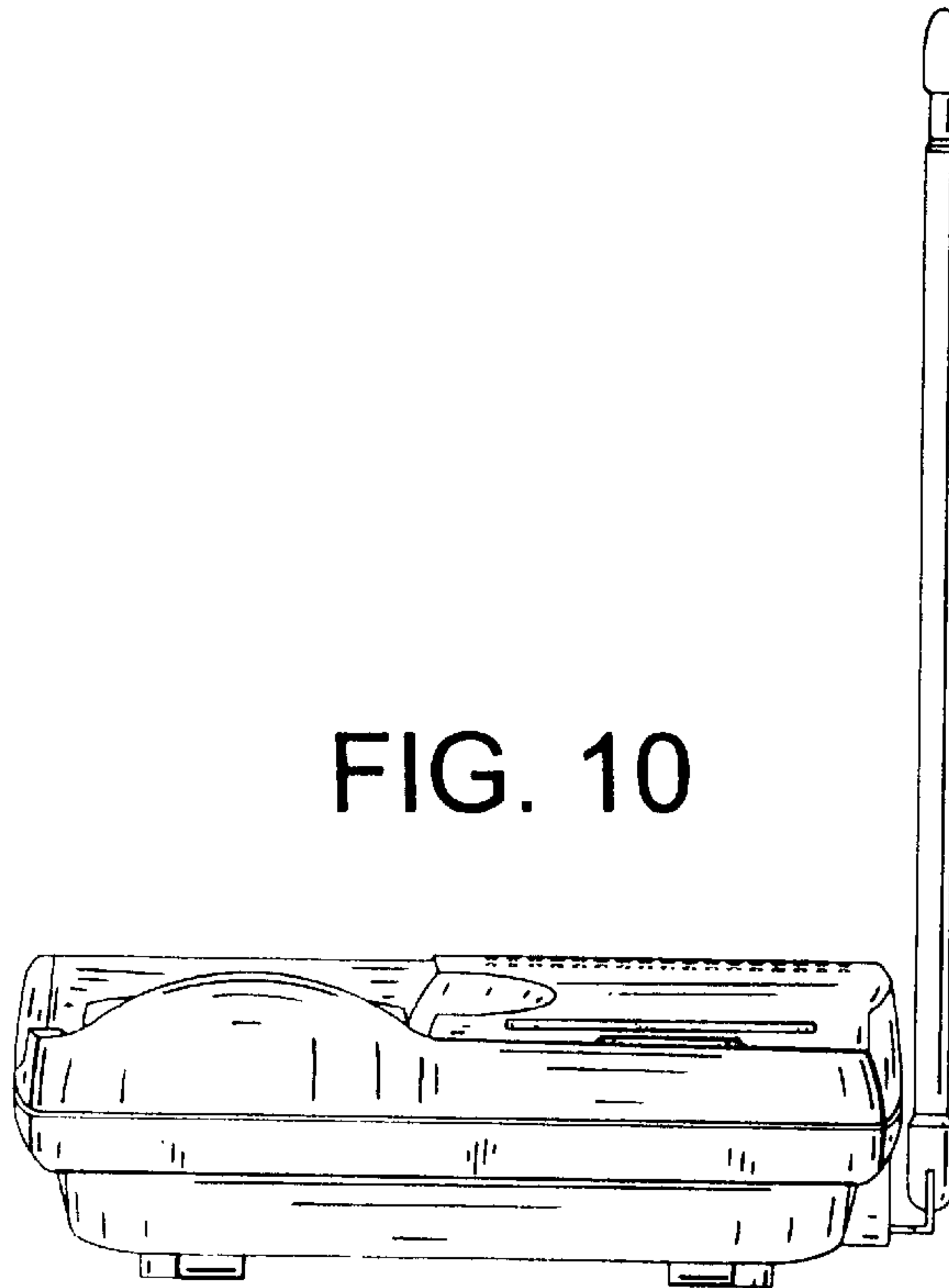

FIG. 11

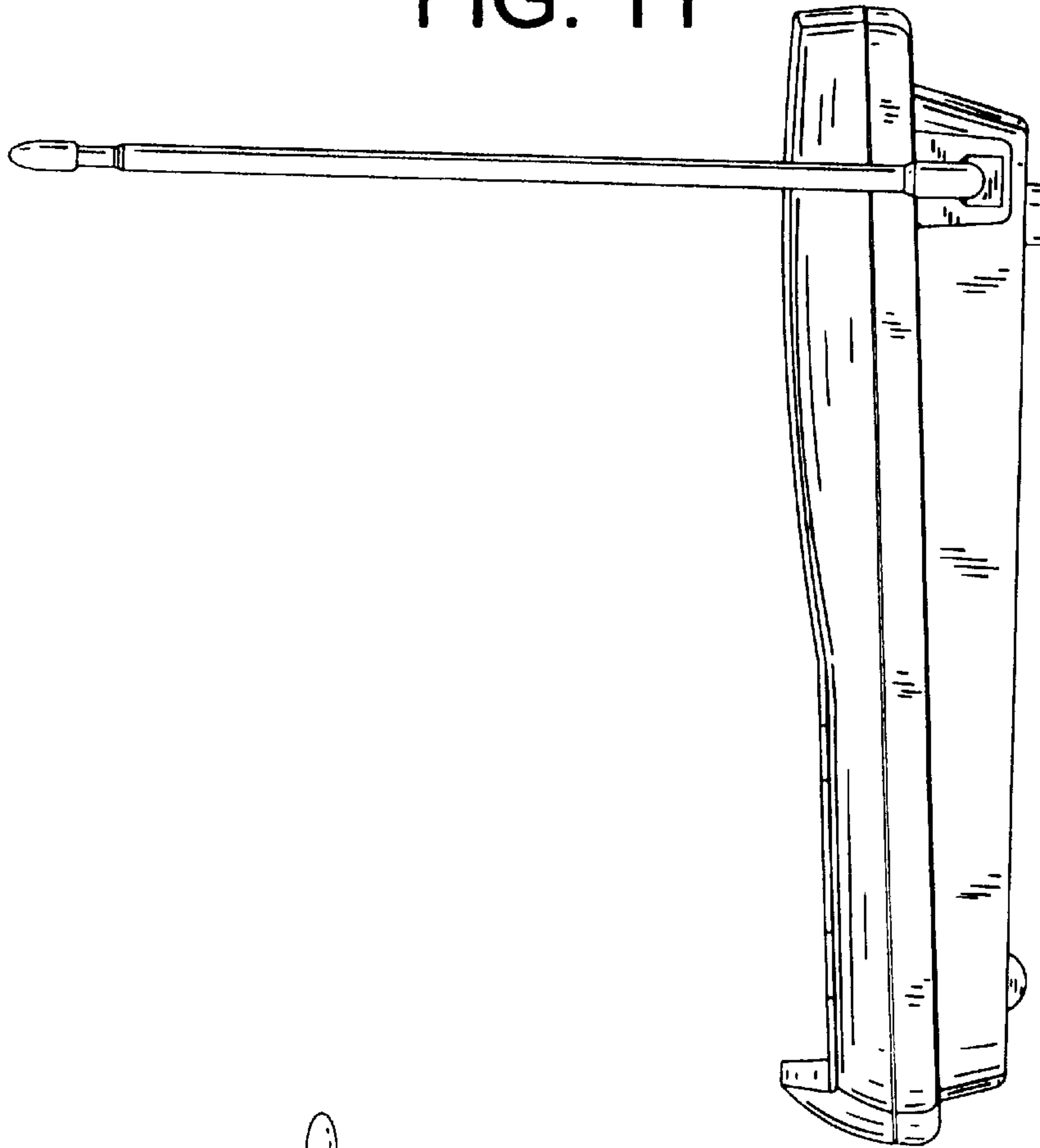

FIG. 12

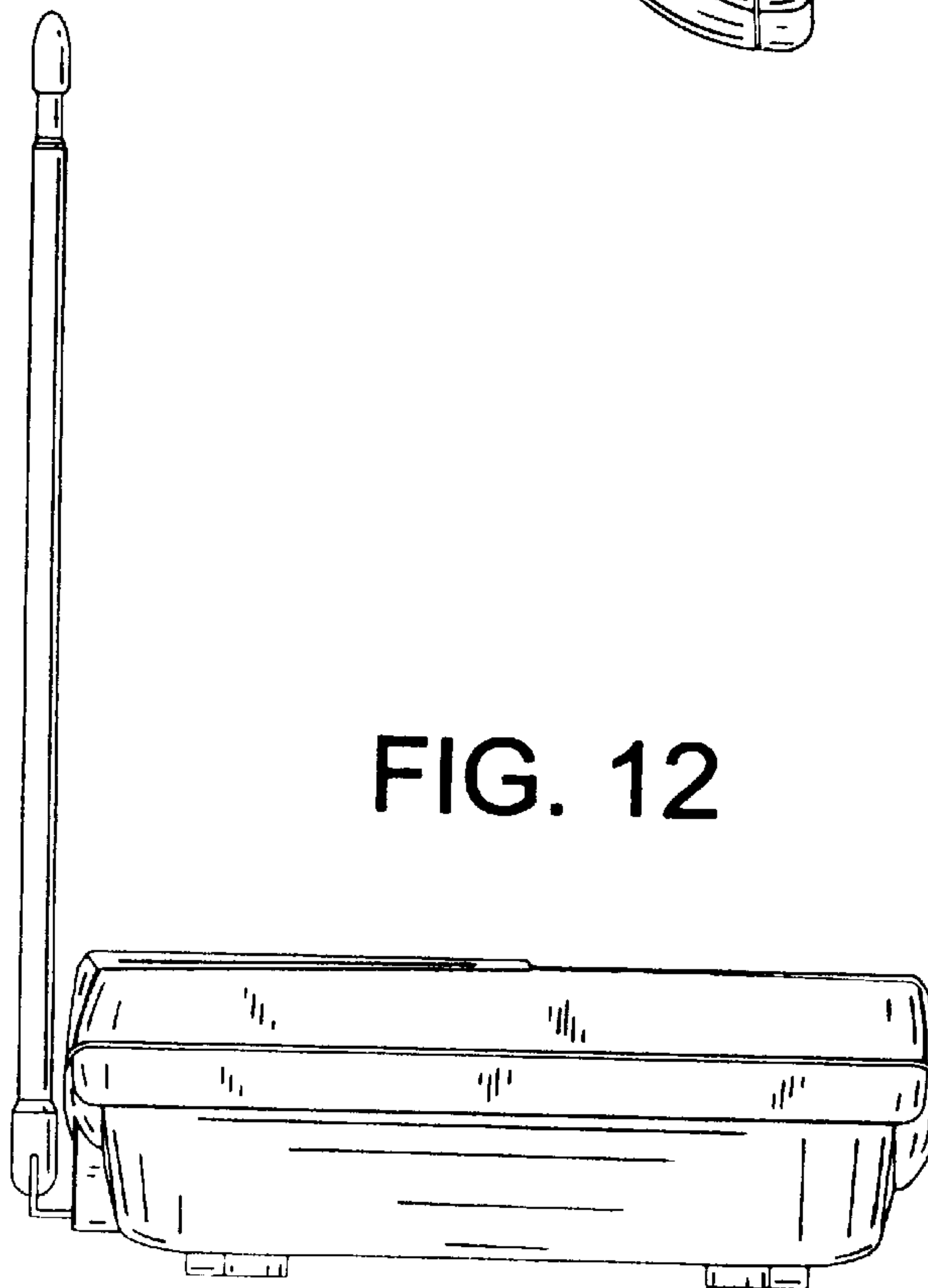

FIG. 13

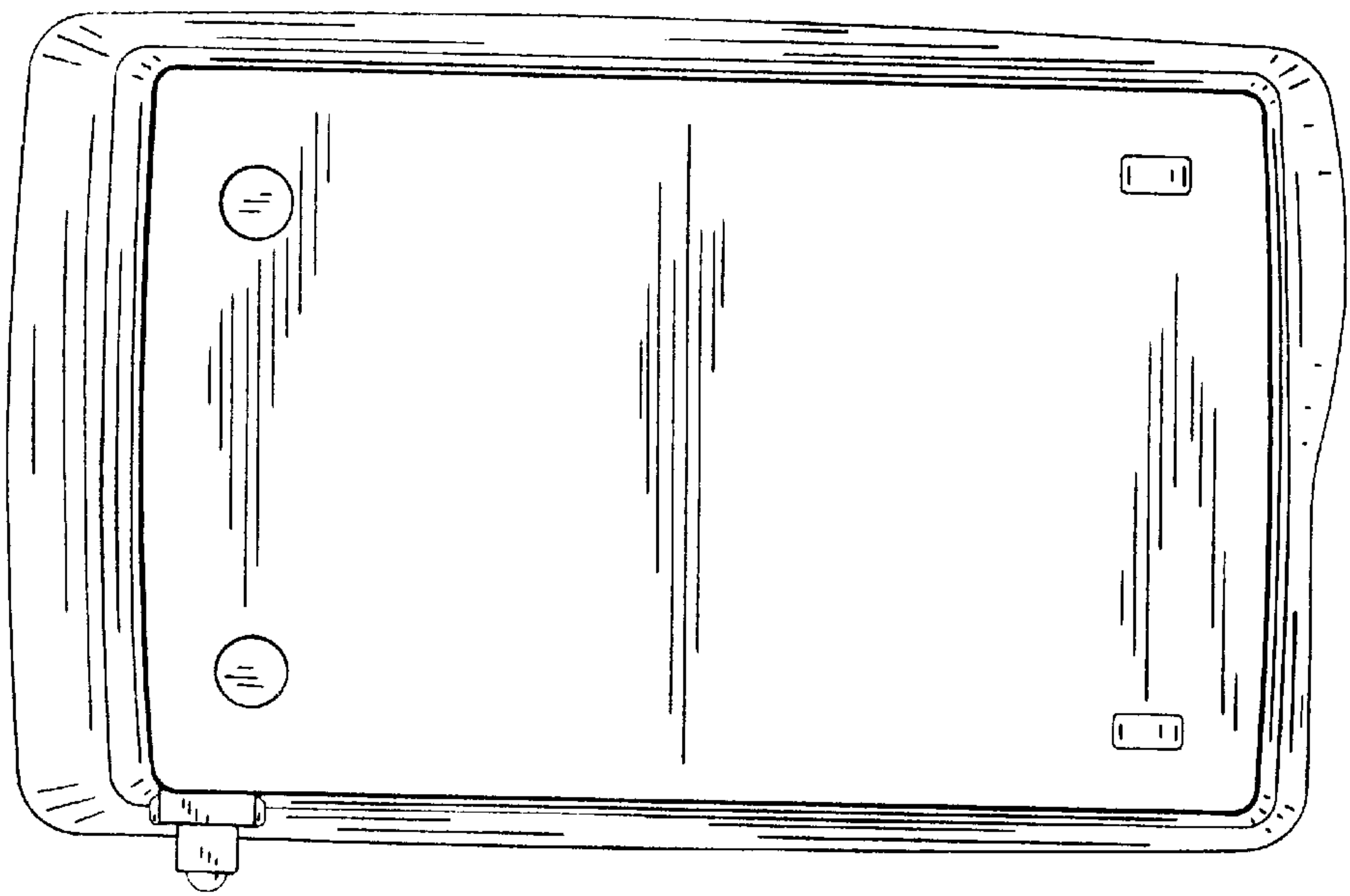

FIG. 14

