



US00D425774S

United States Patent [19]

[11] Patent Number: Des. 425,774

Ford et al.

[45] Date of Patent: ** May 30, 2000

[54] **HINGE ASSEMBLY**

[75] Inventors: **James J. Ford**, West Chester; **Lynn Ziemer**, Glen Mills, both of Pa.

[73] Assignee: **Southco, Inc.**, Concordville, Pa.

[**] Term: **14 Years**

[21] Appl. No.: **29/103,666**

[22] Filed: **Apr. 20, 1999**

[51] **LOC (7) Cl.** **08-06**

[52] **U.S. Cl.** **D8/323**

[58] **Field of Search** D8/323, 327-329;
16/385-389, 260, 261, 262, 265

[56] **References Cited**

U.S. PATENT DOCUMENTS

D. 92,931 7/1934 Sayre .
D. 263,370 3/1982 Bisbing D8/323

(List continued on next page.)

OTHER PUBLICATIONS

Sweet's Architectural Catalog File; Sec 19e/Na; hinges 59-8438; 59-8426, 1962.

(List continued on next page.)

Primary Examiner—B. J. Bullock
Attorney, Agent, or Firm—Paul & Paul

[57] **CLAIM**

The ornamental design for a hinge assembly, as shown and described.

DESCRIPTION

FIG. 1 is a perspective view of a hinge assembly embodying our new design;
FIG. 2 is a front elevation view thereof;
FIG. 3 is a top plan view thereof;
FIG. 4 is a right side elevation view thereof, the left side being a mirror image of the right side;
FIG. 5 is a rear elevation view thereof;
FIG. 6 is a bottom plan view thereof;
FIG. 7 is a front elevation view of the first hinge part thereof;
FIG. 8 is a right side elevation view of the first hinge part thereof, the left side being a mirror image of the right side;
FIG. 9 is a top plan view of the first hinge part thereof;

FIG. 10 is a rear elevation view of the first hinge part thereof;
FIG. 11 is a bottom plan view of the first hinge part thereof;
FIG. 12 is a front elevation view of the second hinge part thereof;
FIG. 13 is a right side elevation view of the second hinge part thereof, the left side being a mirror image of the right side;
FIG. 14 is a top plan view of the second hinge part thereof;
FIG. 15 is a rear elevation view of the second hinge part thereof;
FIG. 16 is a bottom plan view of the second hinge part thereof;
FIG. 17 is a front elevation view of a second embodiment of a hinge assembly embodying our new design;
FIG. 18 is a top plan view of the second embodiment;
FIG. 19 is a right side elevation view of the second embodiment, the left side being a mirror image of the right side;
FIG. 20 is a rear elevation view of the second embodiment;
FIG. 21 is a bottom plan view of the second embodiment;
FIG. 22 is a front elevation view of the first hinge part of the second embodiment;
FIG. 23 is a right side elevation view of the first hinge part of the second embodiment, the left side being a mirror image of the right side;
FIG. 24 is a top plan view of the first hinge part of the second embodiment;
FIG. 25 is a rear elevation view of the first hinge part of the second embodiment;
FIG. 26 is a bottom plan view of the first hinge part of the second embodiment;
FIG. 27 is a front elevation view of the second hinge part of the second embodiment;
FIG. 28 is a right side elevation view of the second hinge part of the second embodiment, the left side being a mirror image of the right side;
FIG. 29 is a top plan view of the second hinge part of the second embodiment;
FIG. 30 is a rear elevation view of the second hinge part of the second embodiment; and,
FIG. 31 is a bottom plan view of the second hinge part of the second embodiment.

FIGS. 7-16 and 22-31 are shown separately for clarity of illustration.

The solid line around the bottom of the hinge in the second embodiment represents the bounds of the embodiment as the bottom forms no part of thereof. The broken lines are for illustrative purposes only and form no part of the claimed embodiment.

1 Claim, 7 Drawing Sheets

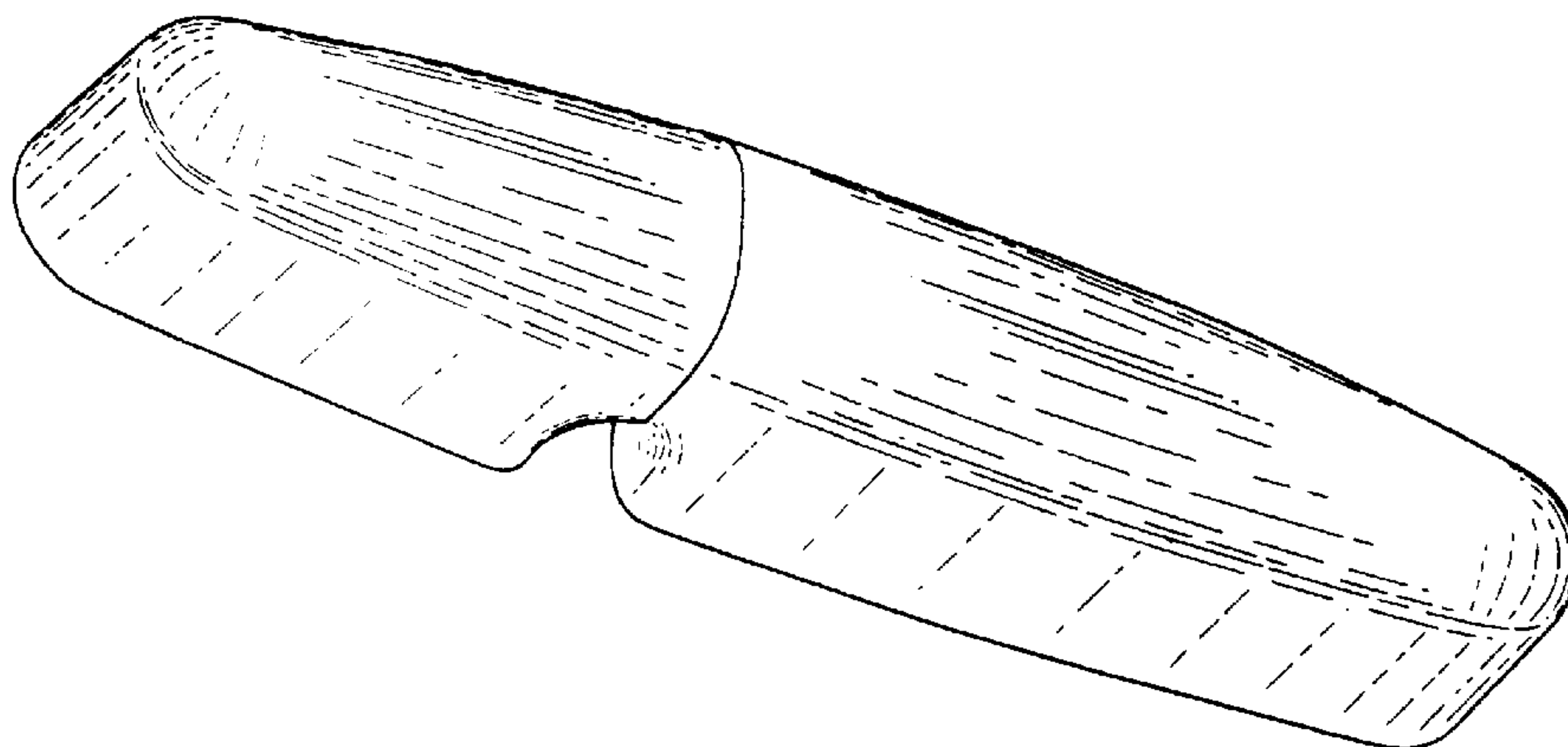

Des. 425,774

Page 2

U.S. PATENT DOCUMENTS

D. 263,446	3/1982	Bisbing	D8/323	D. 339,518	9/1993	Bisbing	D8/323
D. 268,733	4/1983	Bisbing	D8/323	D. 348,823	7/1994	Bisbing	D8/323
D. 269,943	8/1983	Bisbing	D8/323	2,591,476	4/1952	Swanson	.	
D. 303,491	9/1989	Bisbing	D8/323					
D. 303,492	9/1989	Bisbing	D8/323					
D. 339,051	9/1993	Bisbing	D8/323					
D. 339,052	9/1993	Bisbing	D8/323					
D. 339,281	9/1993	Bisbing	D8/323					

OTHER PUBLICATIONS

L'Architecture d'Aujourd'hui; p. 110, hinges (top right) & (center left), Sep. 1962.

Guden Weld-On Hinge, Product Literature, May 15, 1998.

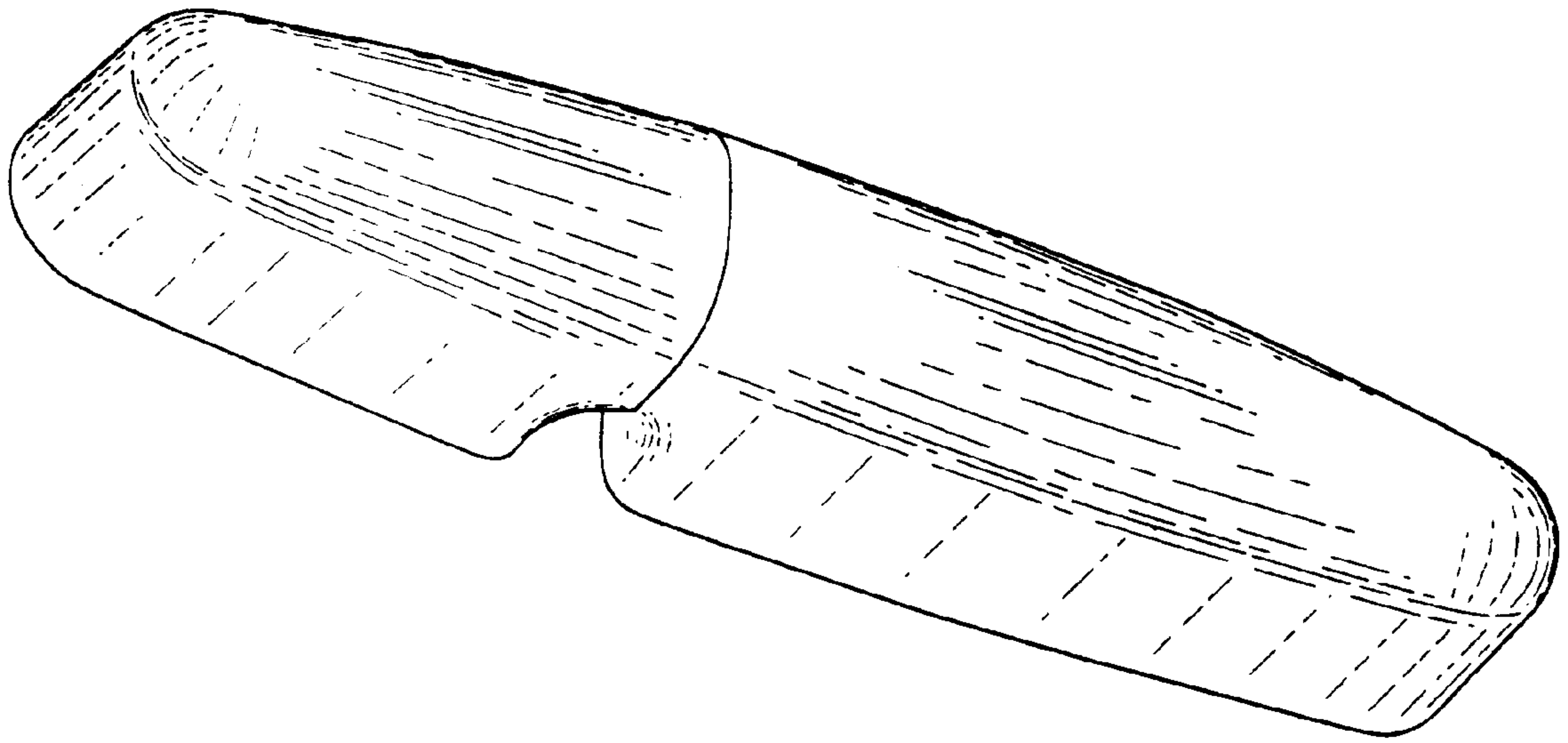

FIG. 1

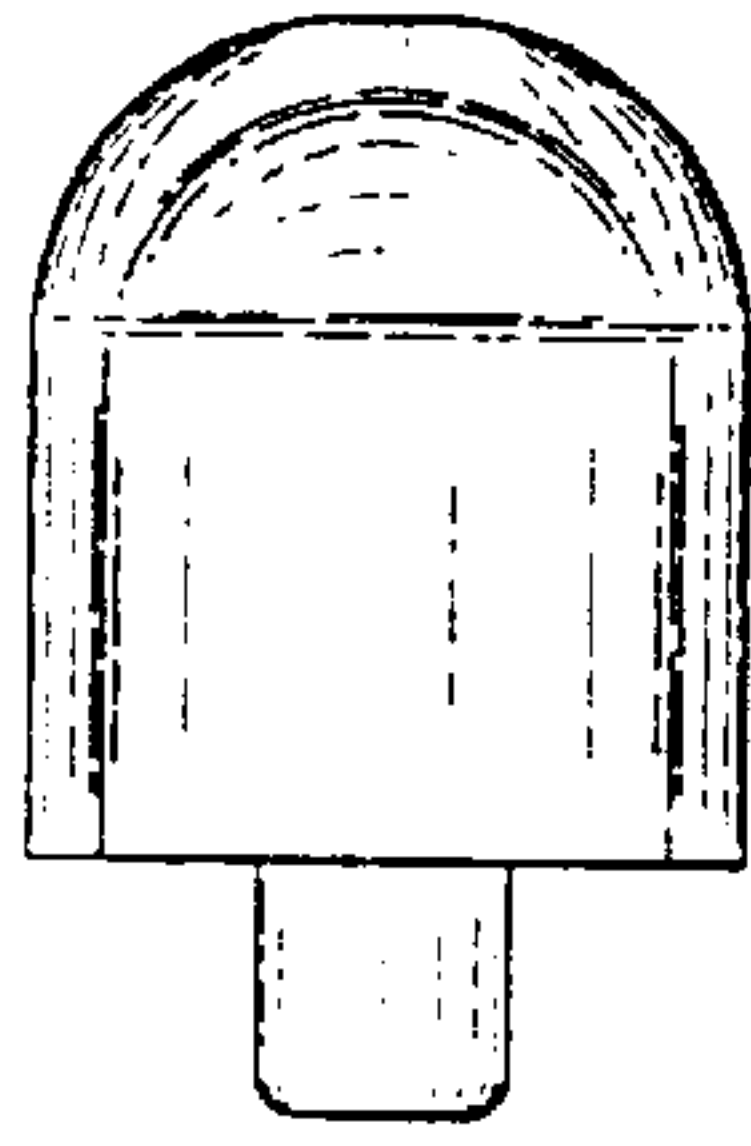

FIG. 2

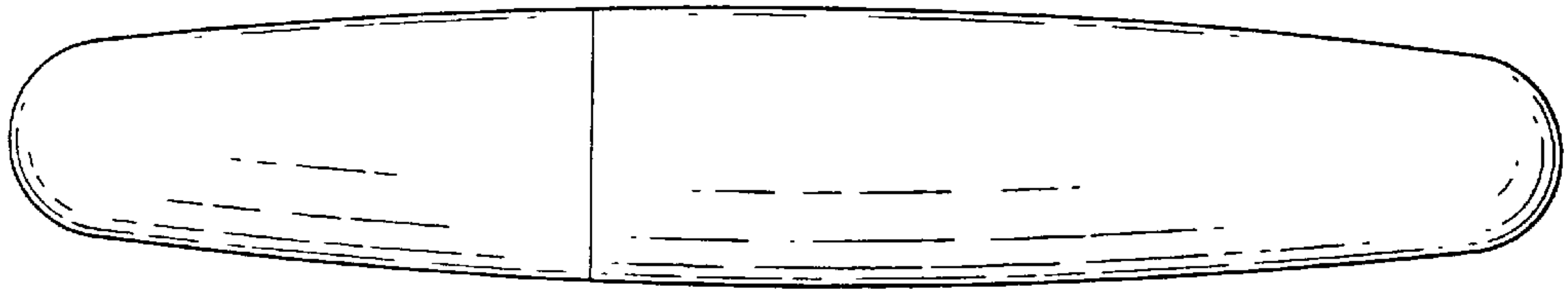

FIG. 3

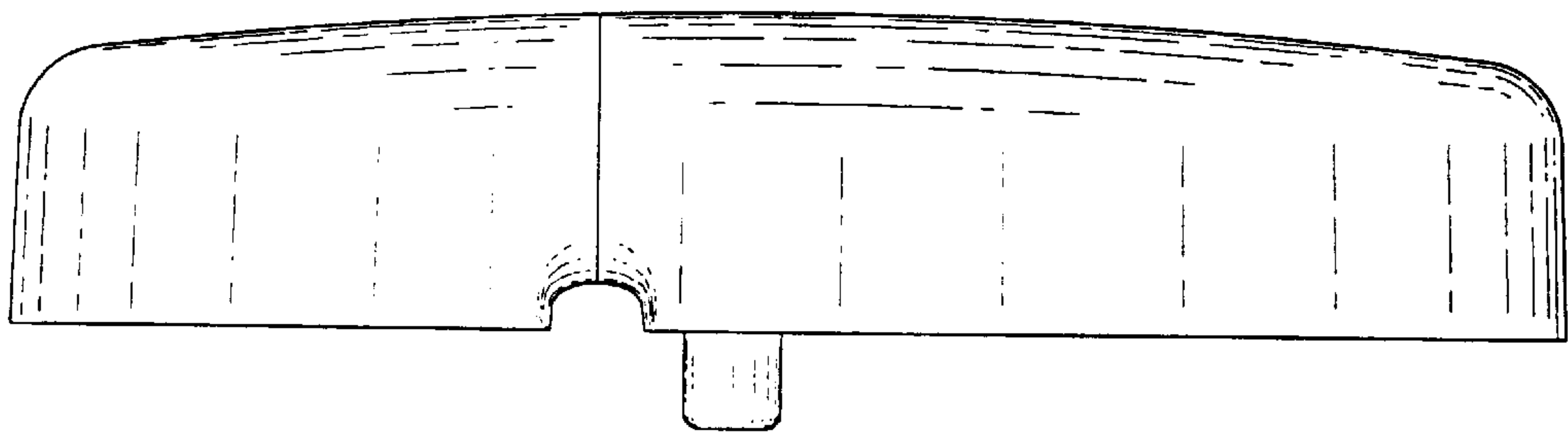

FIG. 4

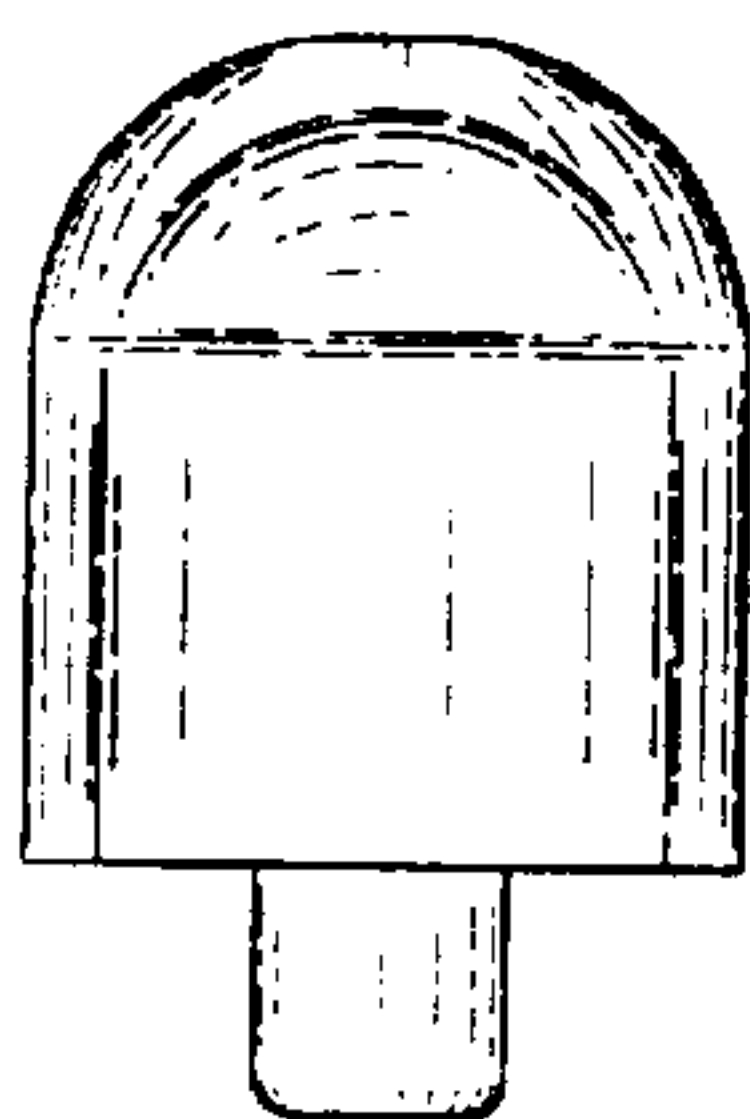

FIG. 5

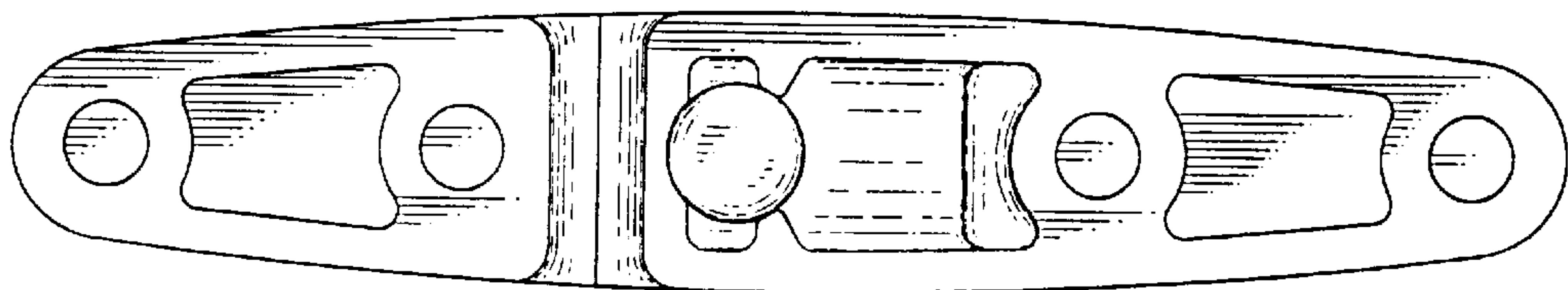

FIG. 6

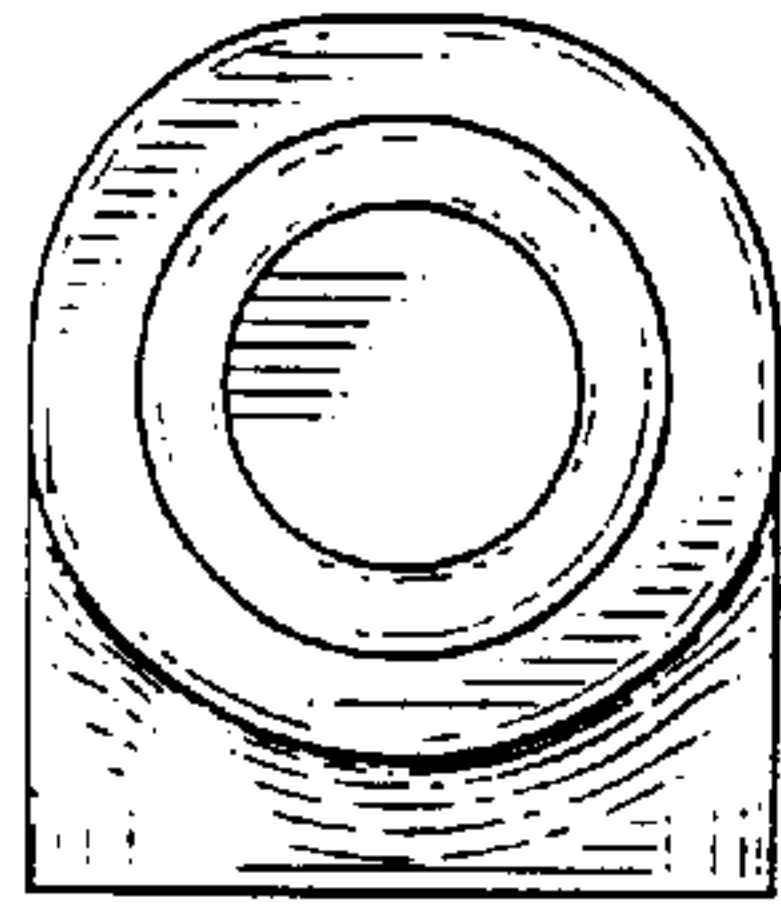

FIG. 7

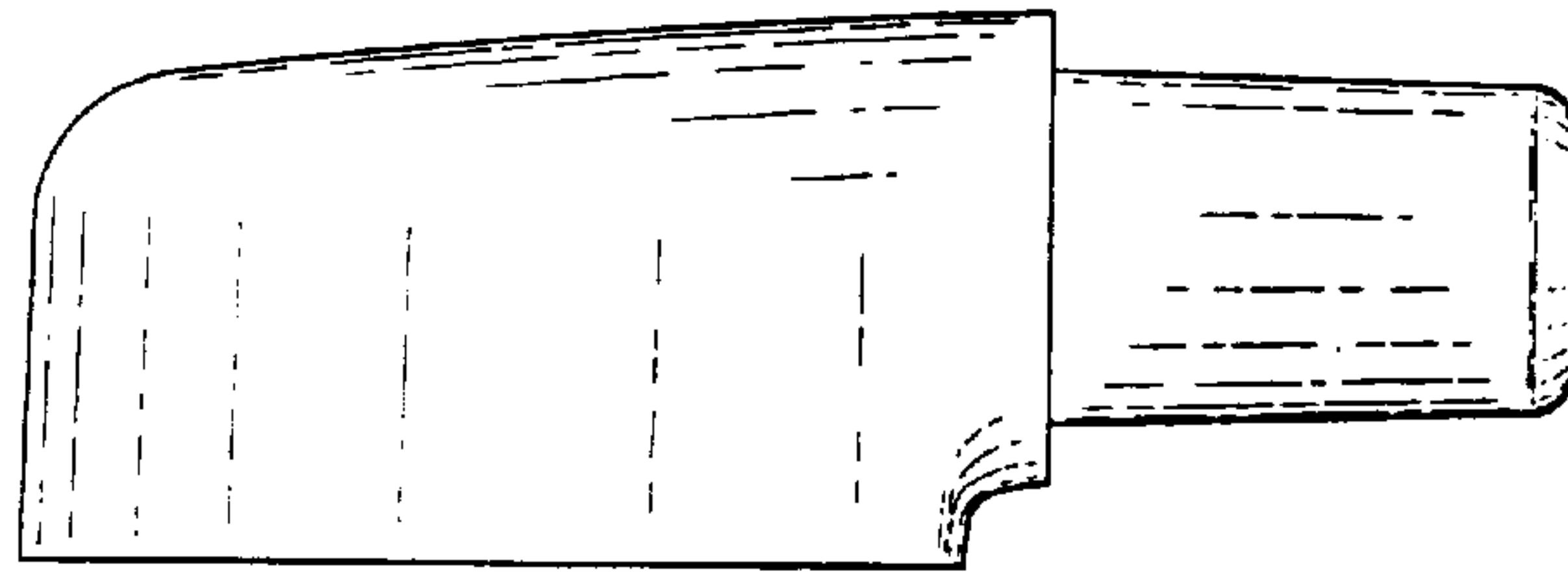

FIG. 8

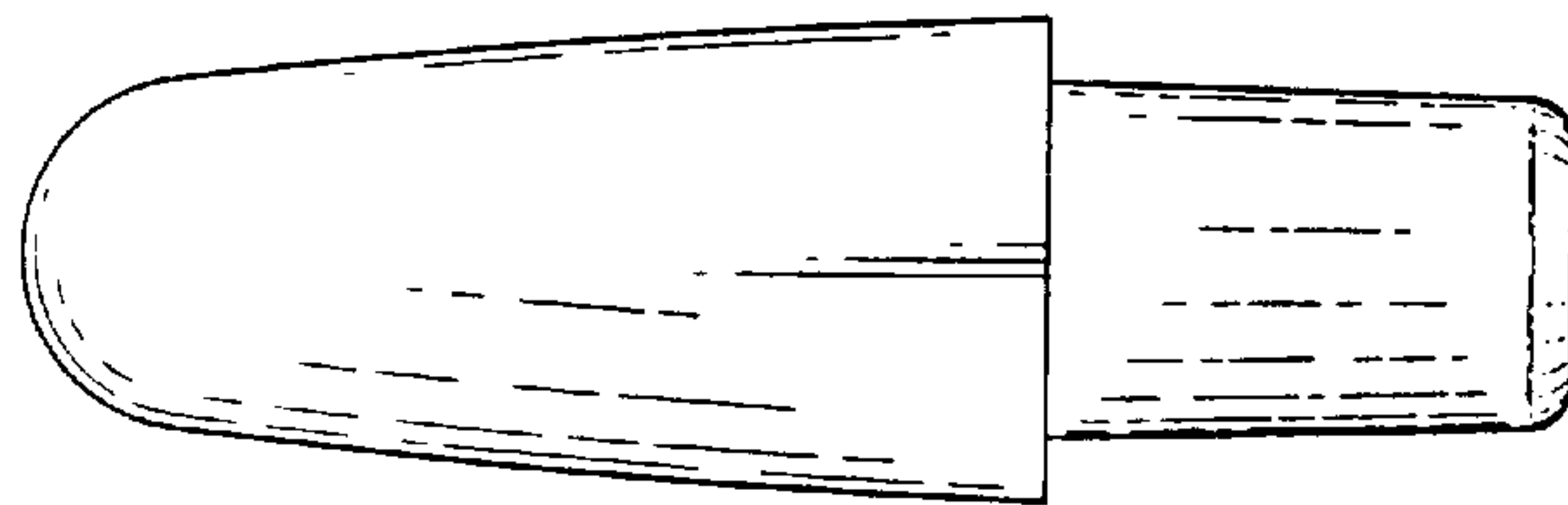

FIG. 9

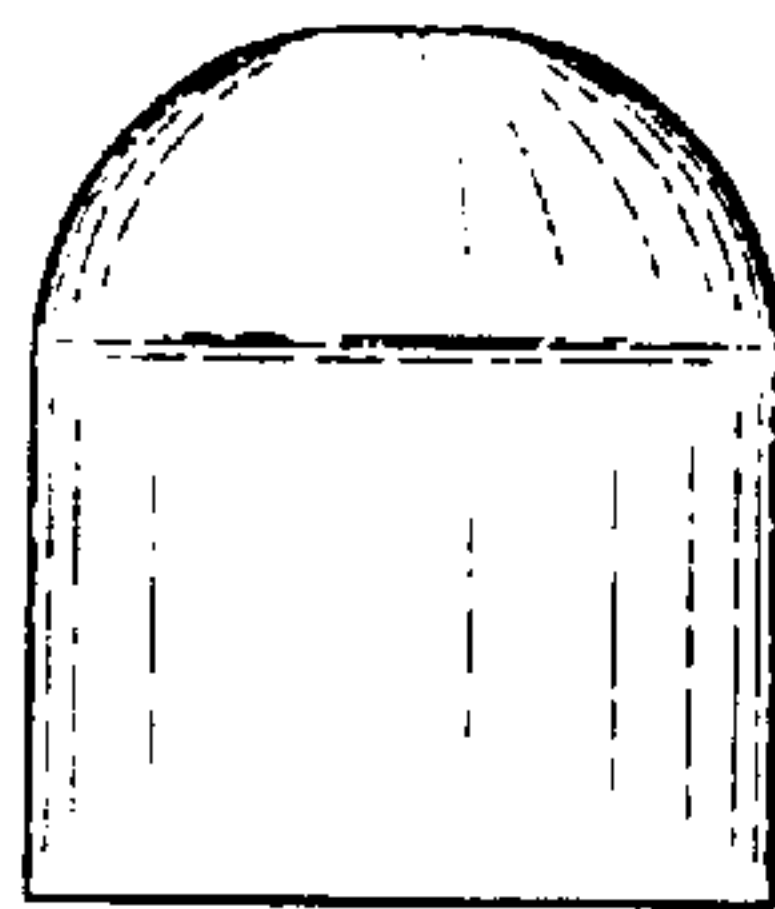

FIG. 10

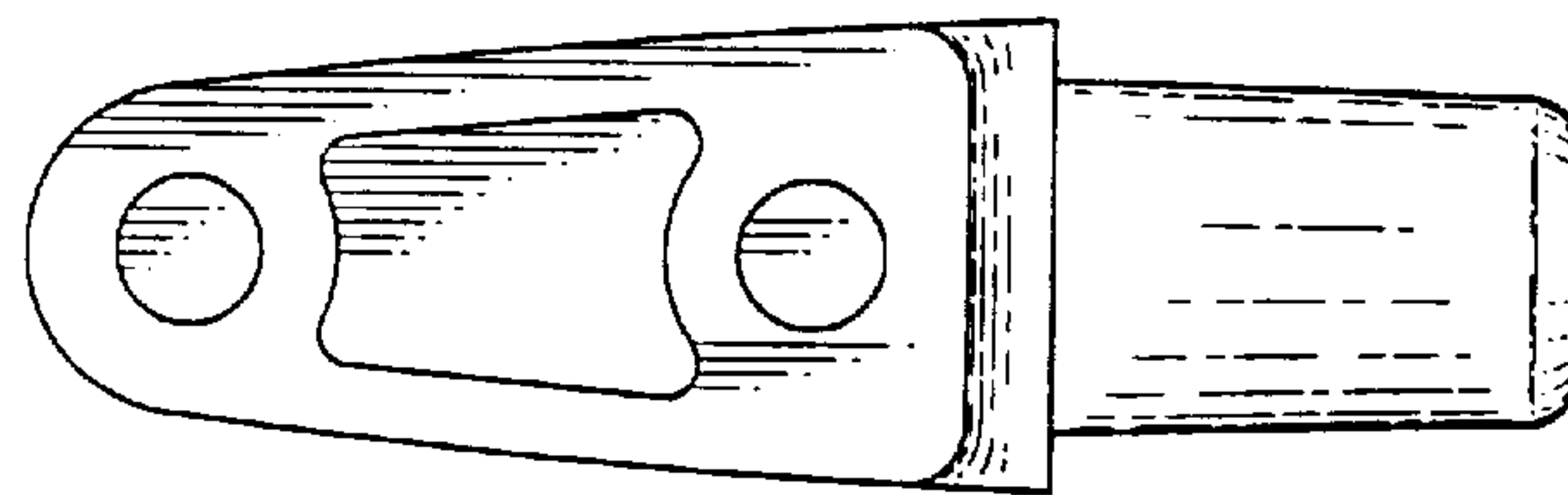

FIG. 11

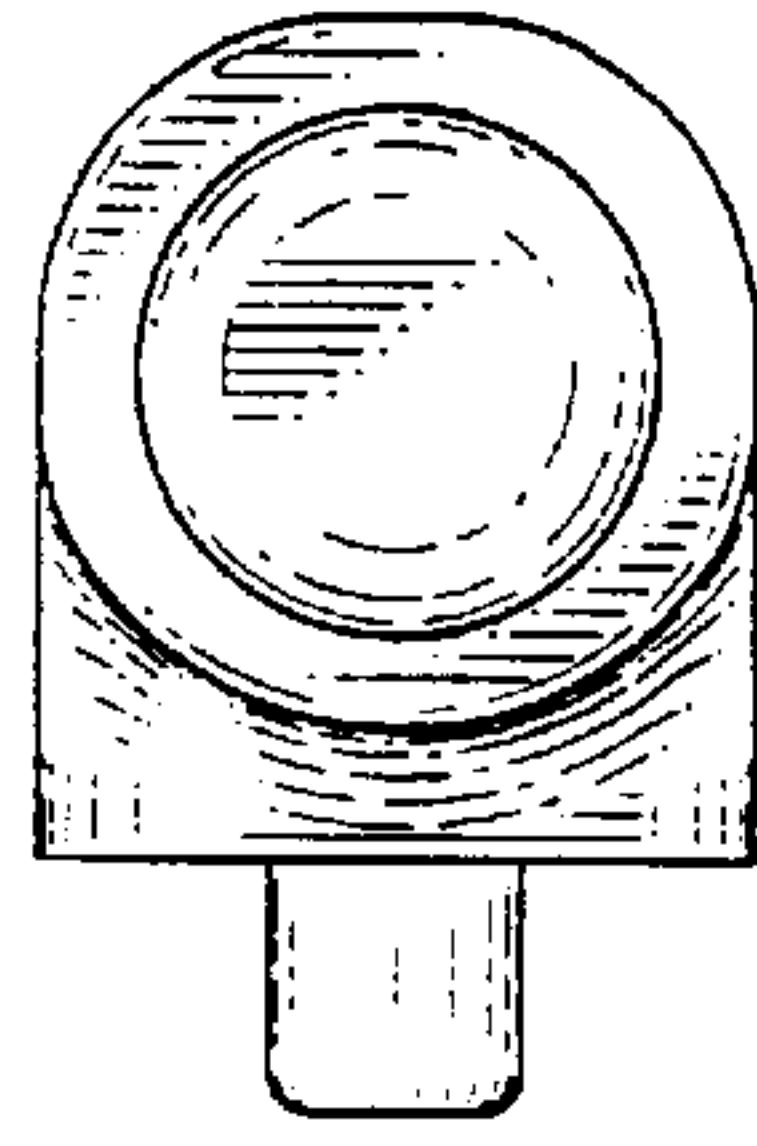

FIG. 12

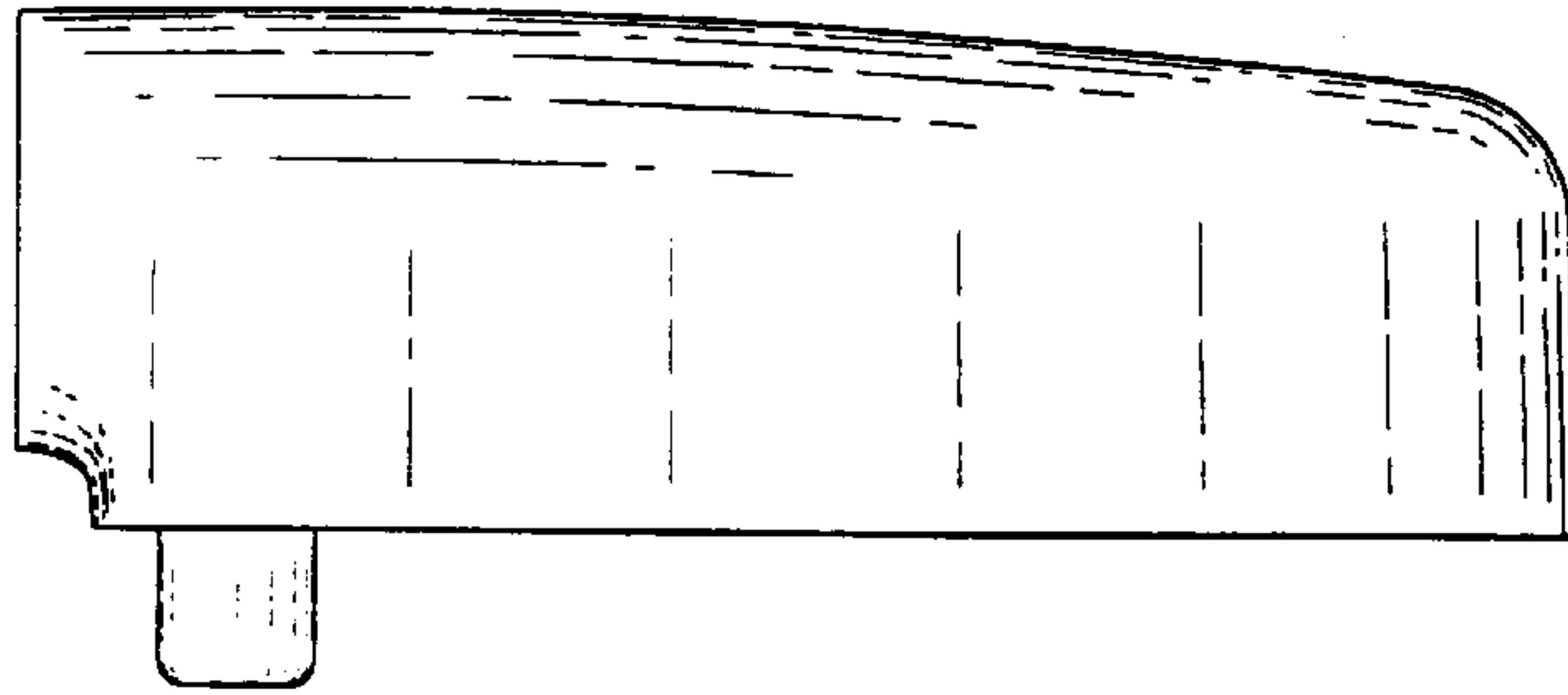

FIG. 13

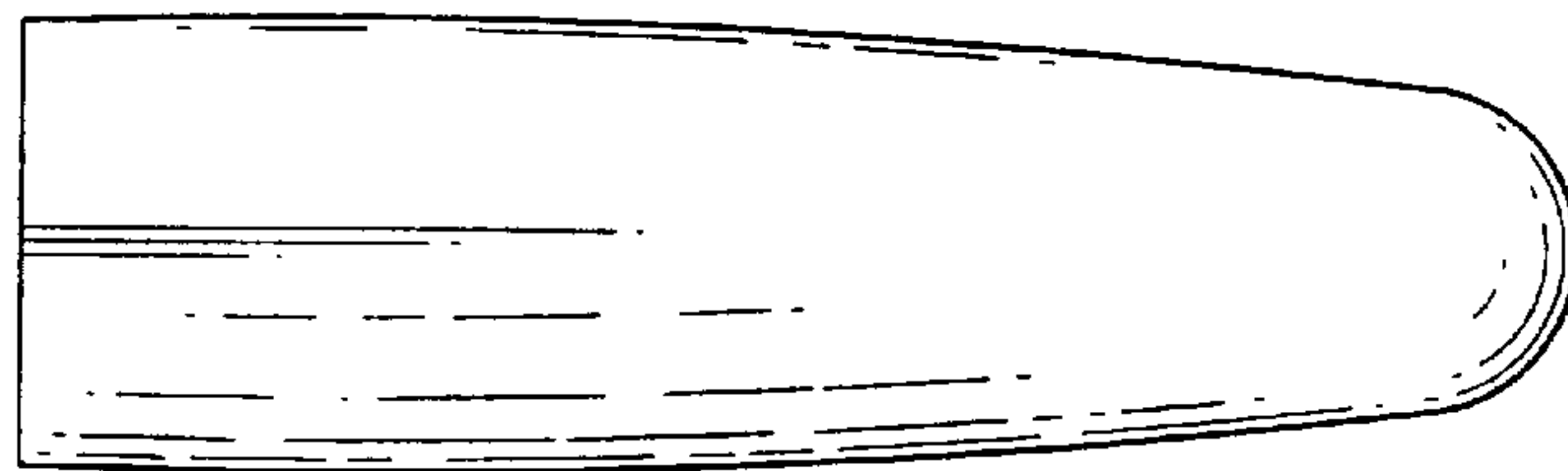

FIG. 14

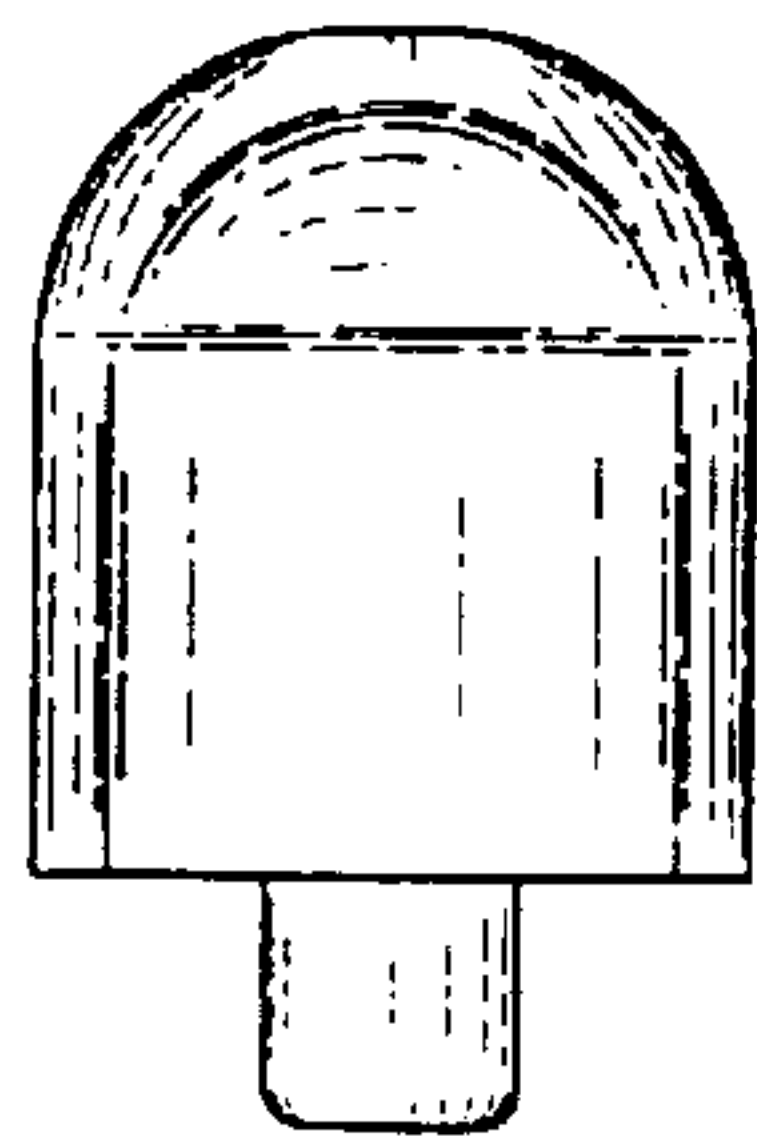

FIG. 15

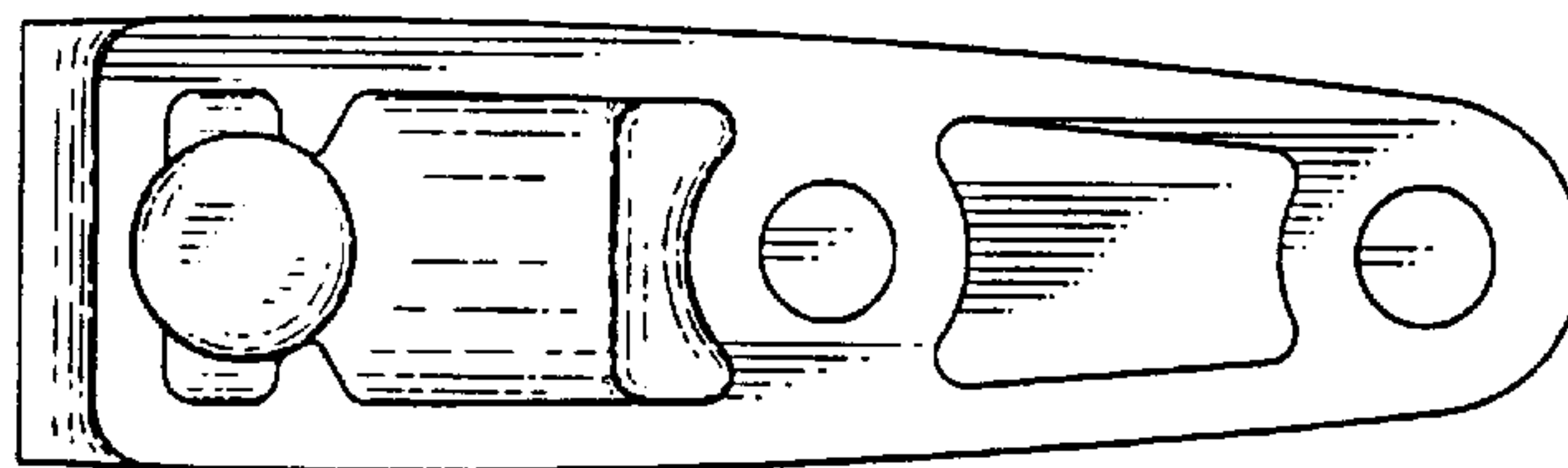

FIG. 16

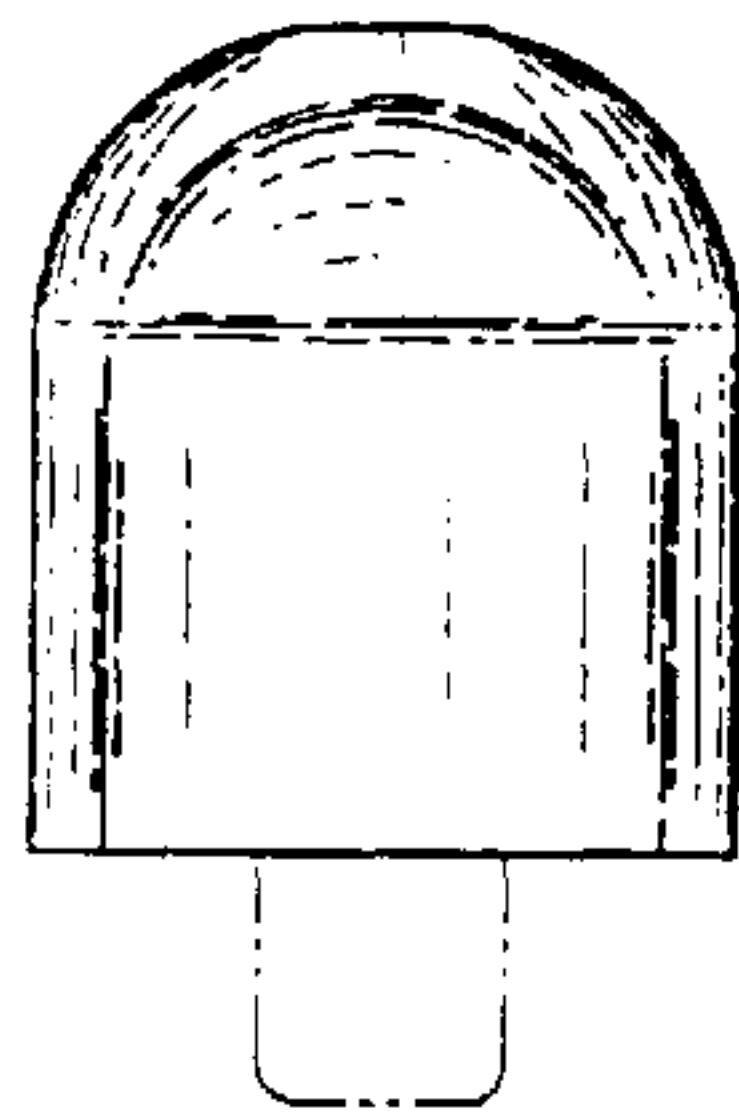

FIG. 17

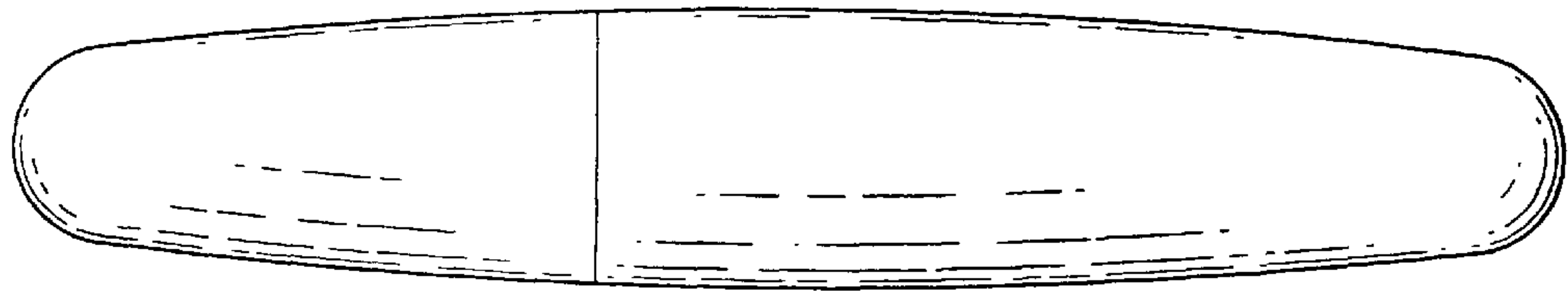

FIG. 18

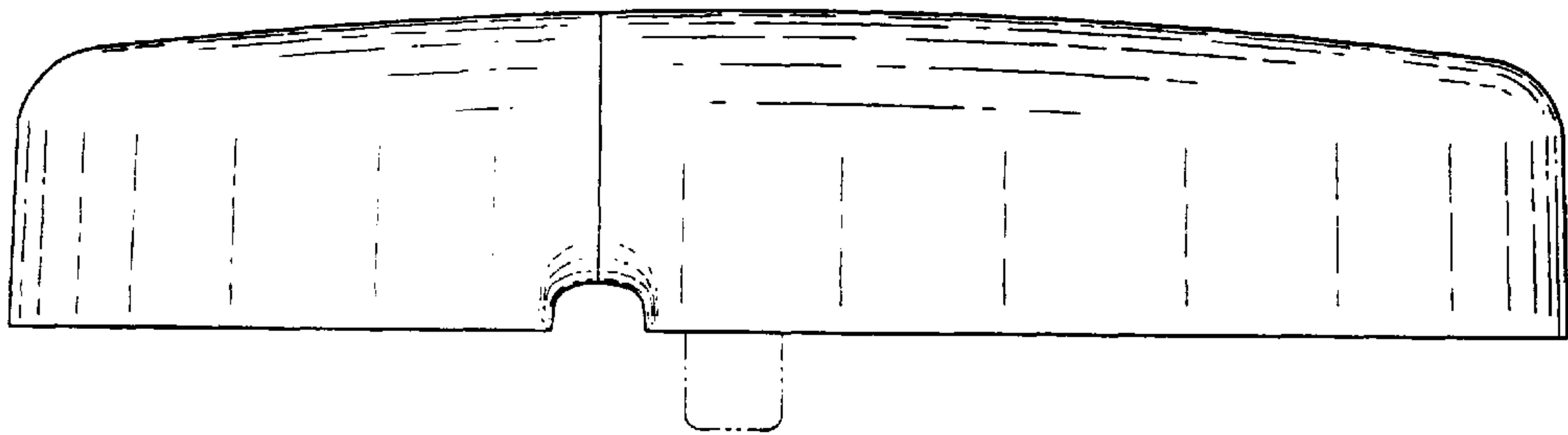

FIG. 19

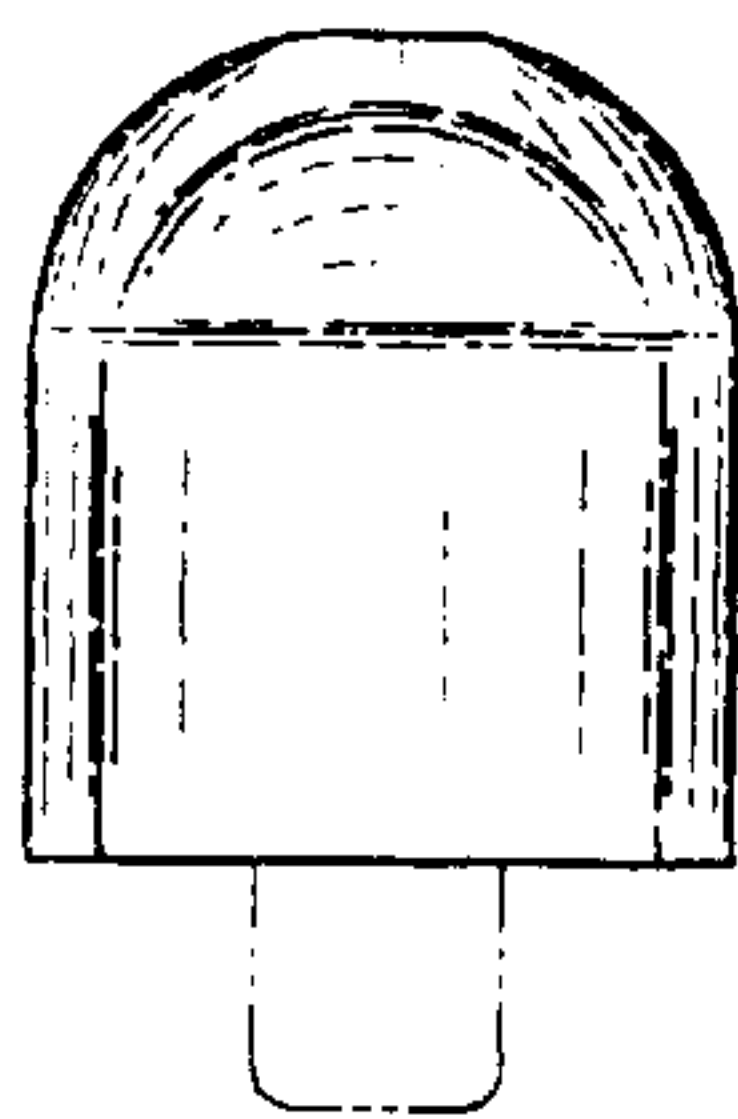

FIG. 20

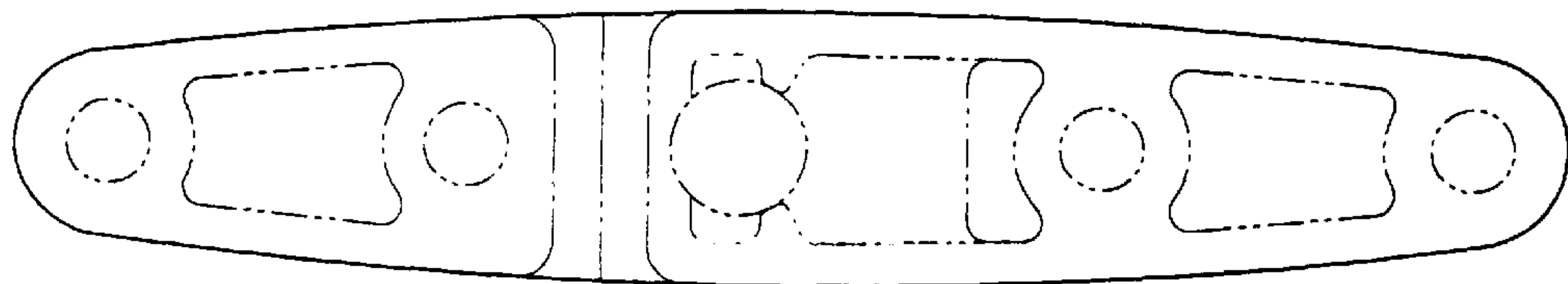

FIG. 21

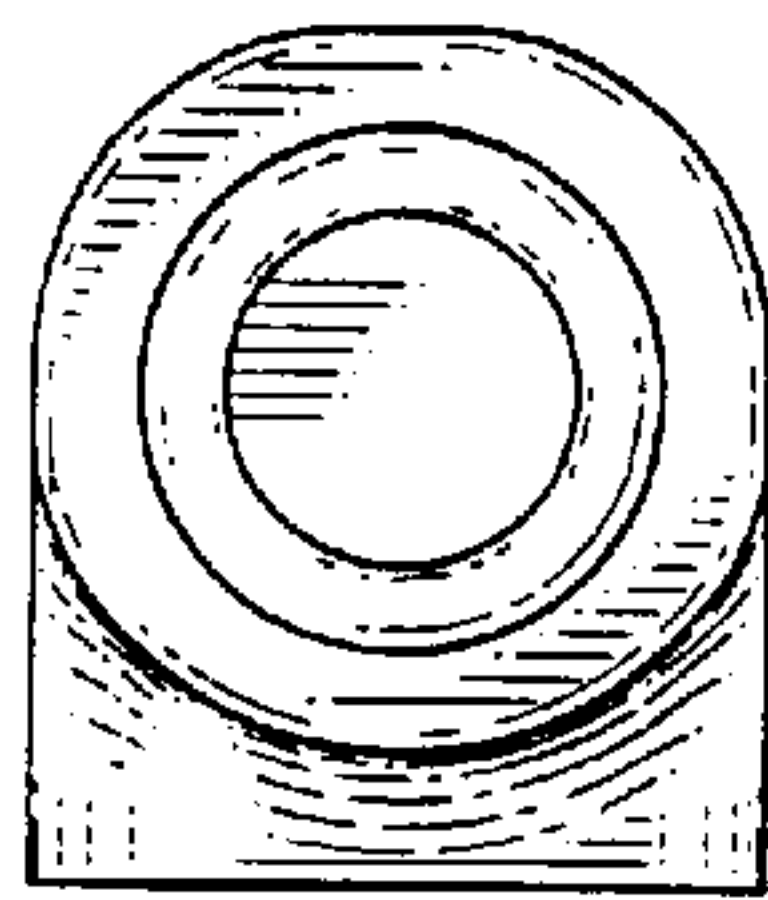

FIG. 22

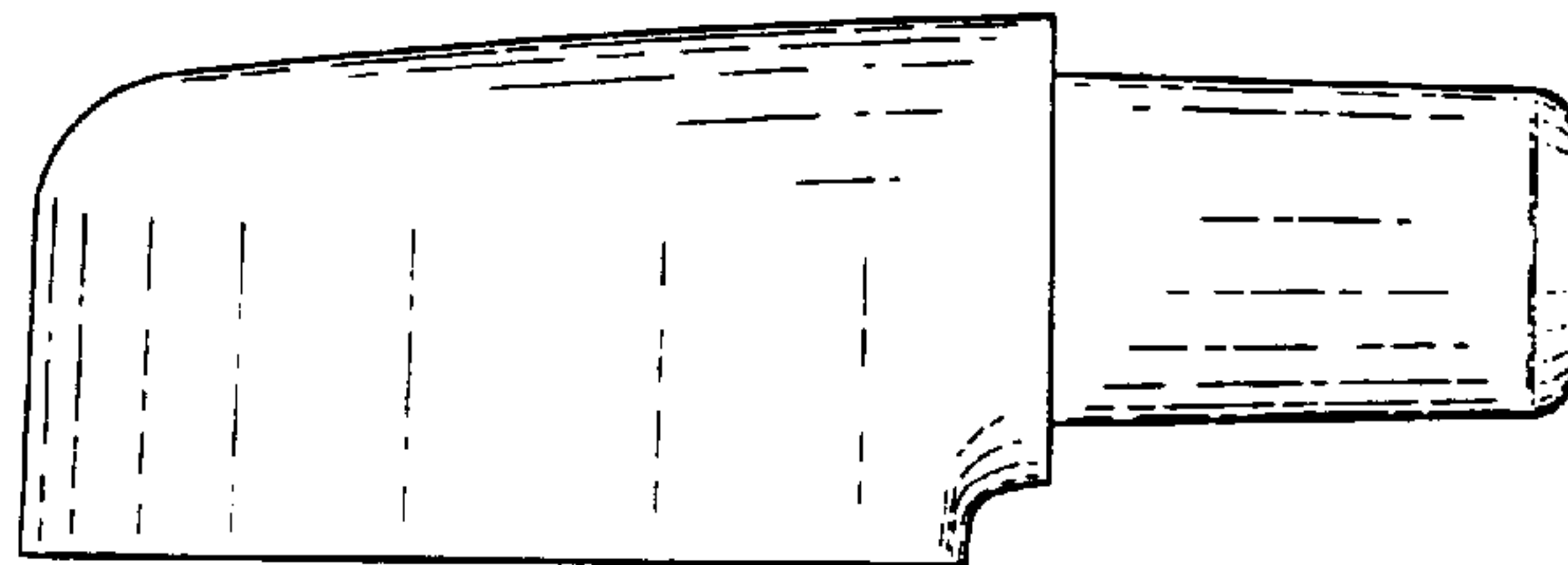

FIG. 23



FIG. 24

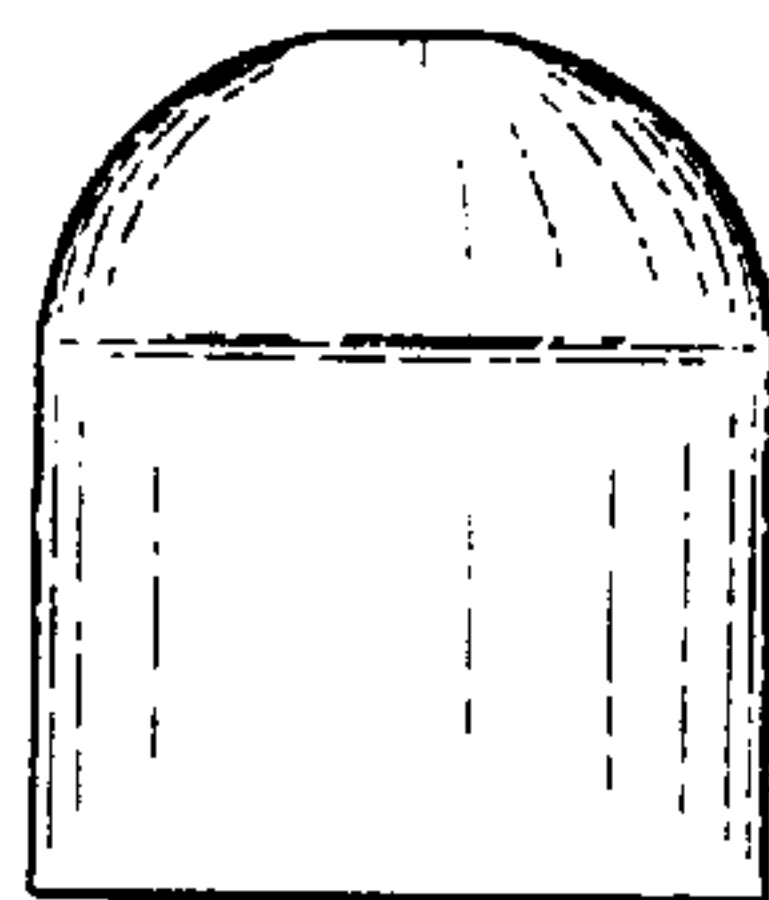

FIG. 25

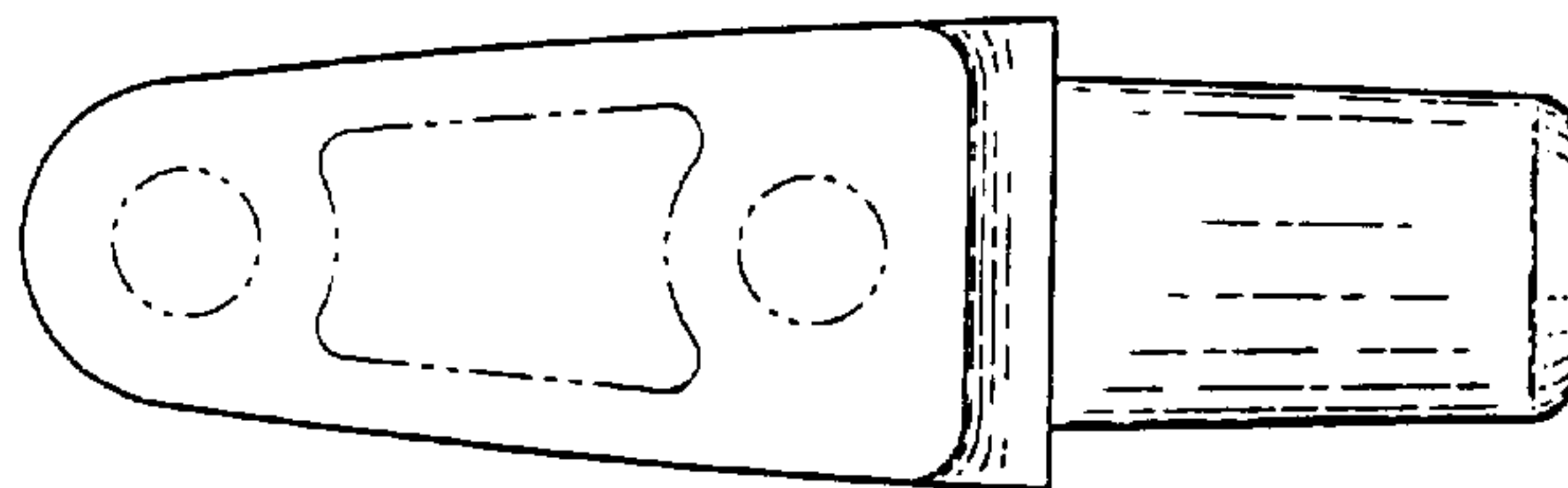

FIG. 26

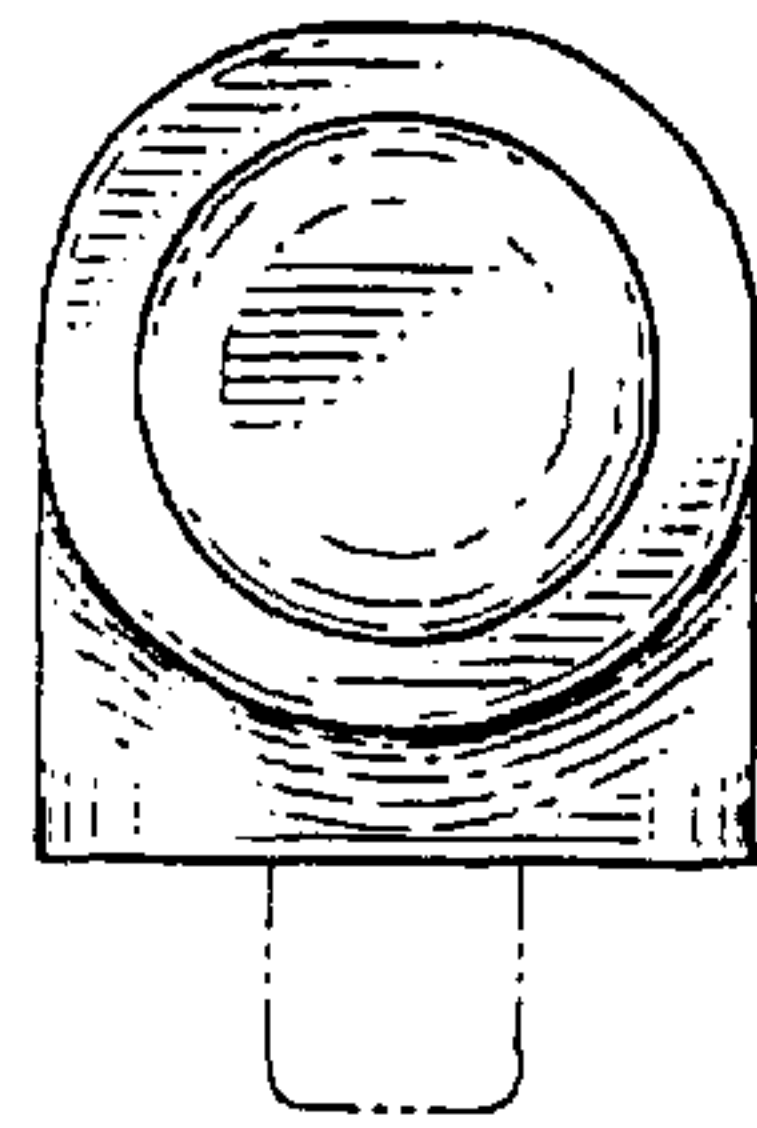

FIG. 27

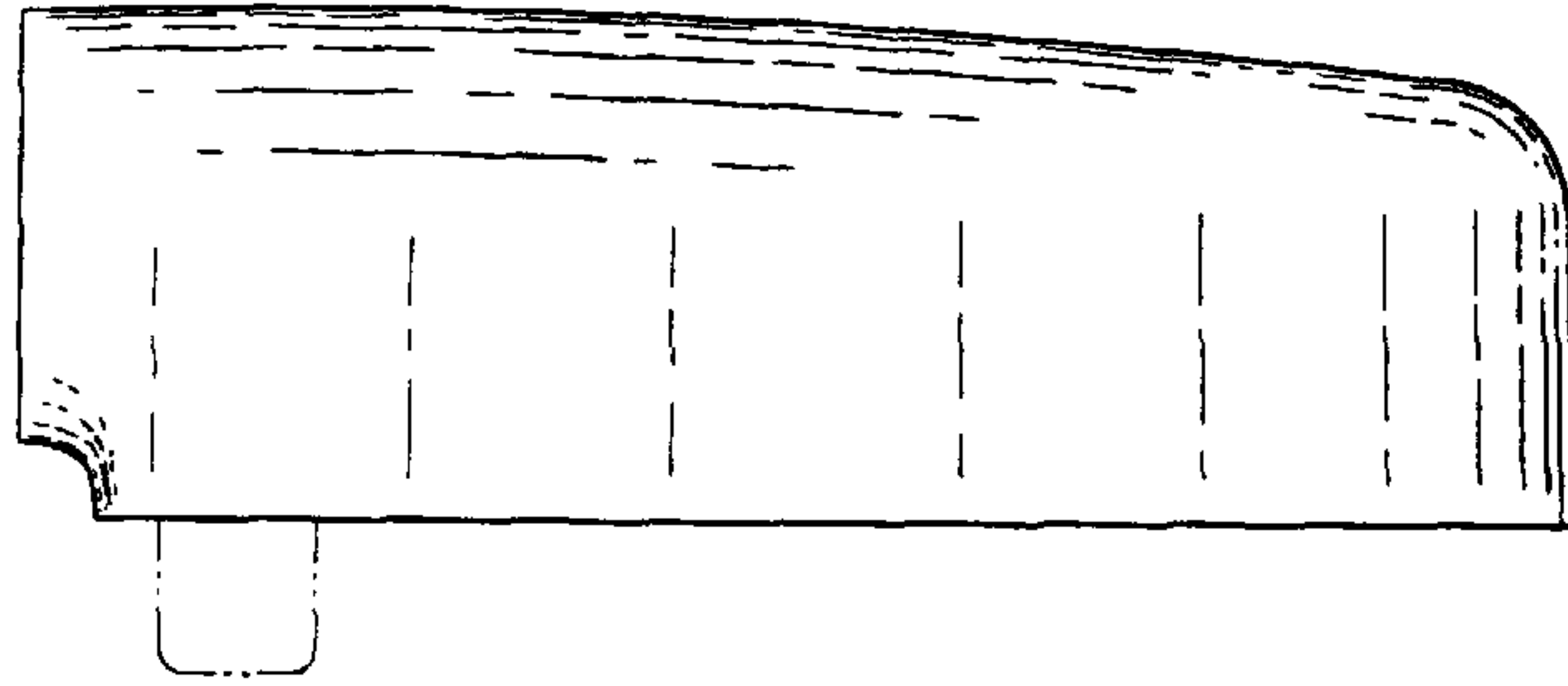

FIG. 28

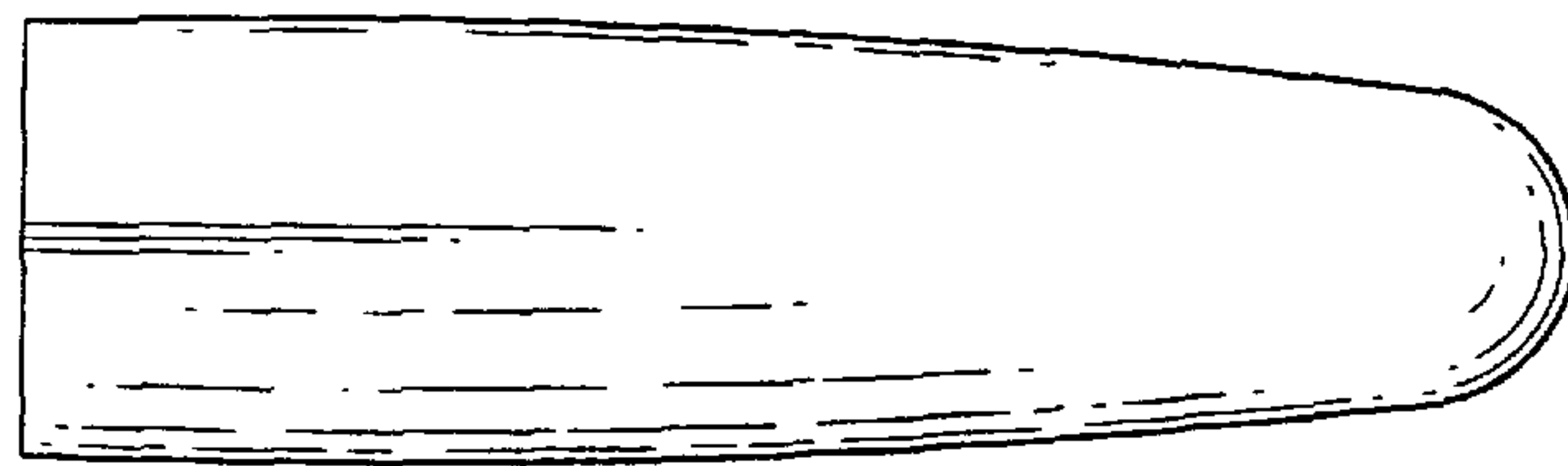

FIG. 29

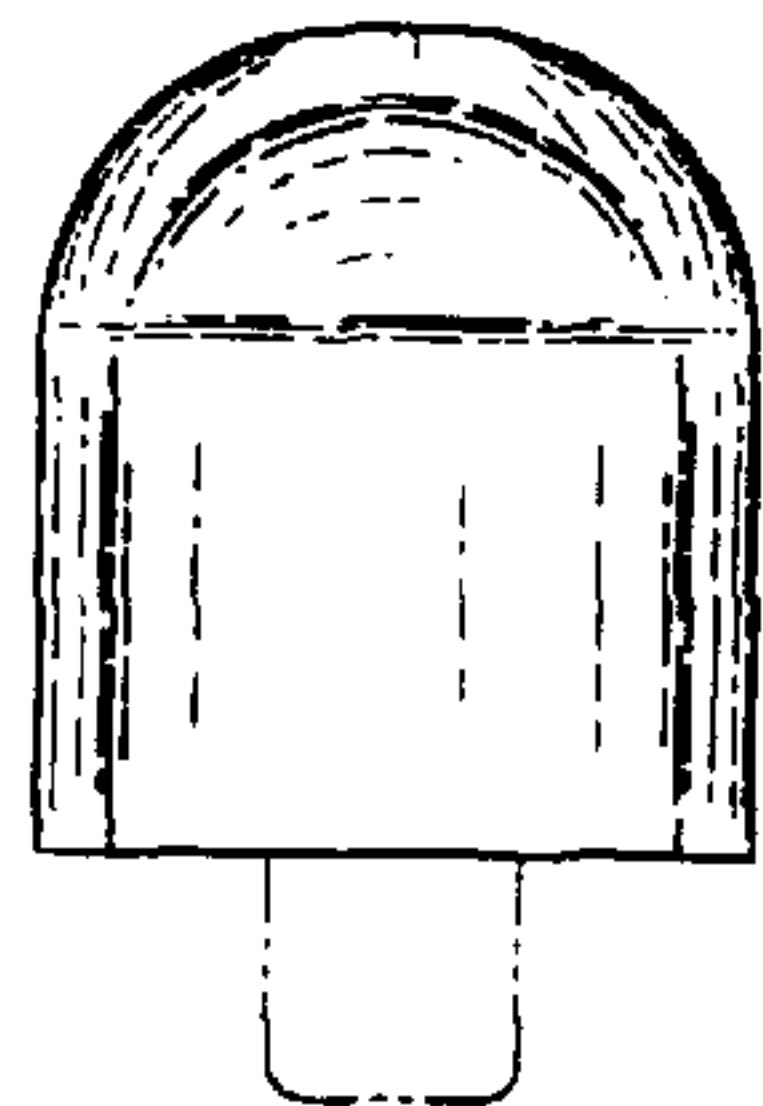

FIG. 30

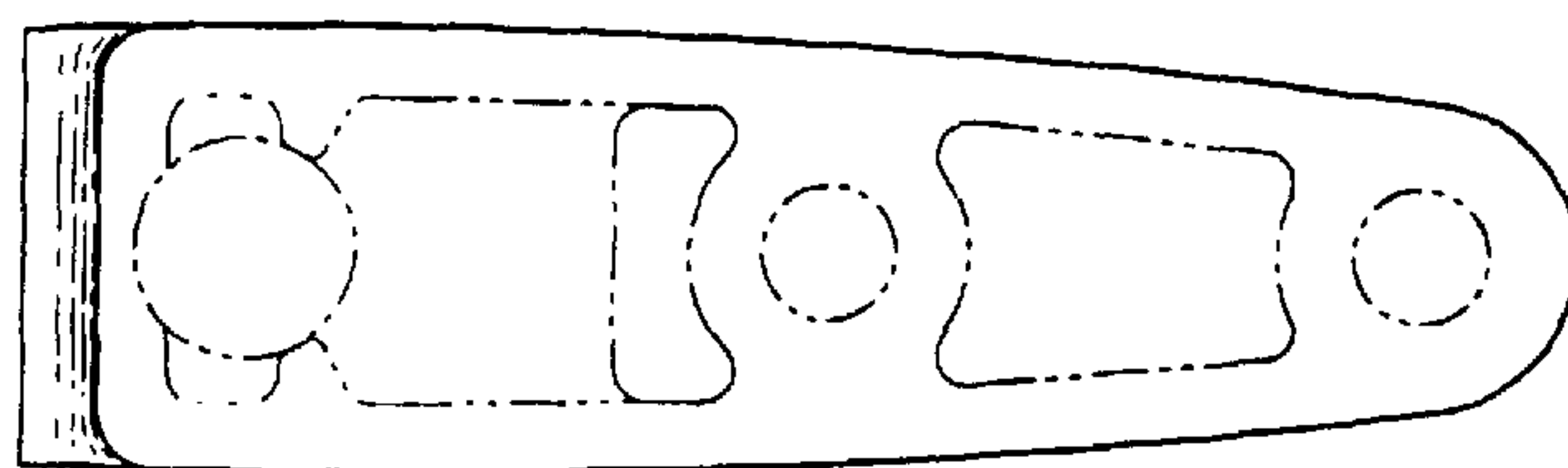

FIG. 31