



US00D425612S

United States Patent [19]
Andersen

[11] **Patent Number: Des. 425,612**

[45] **Date of Patent: ** May 23, 2000**

[54] **UNIVERSAL ELBOW**

[75] Inventor: **John L. Andersen**, Jacksonville, Tex.

[73] Assignee: **Builder's Best, Inc.**, Jacksonville, Tex.

[**] Term: **14 Years**

[21] Appl. No.: **29/091,310**

[22] Filed: **Jul. 27, 1998**

D. 342,130 12/1993 Anderson D23/393
5,645,482 7/1997 Moss et al. 454/339

Primary Examiner—Lisa Lichtenstein
Attorney, Agent, or Firm—Price, Heneveld, Cooper, DeWitt & Litton

[57] **CLAIM**

The ornamental design for a universal elbow, as shown and described.

Related U.S. Application Data

[63] Continuation of application No. 29/080,629, Dec. 11, 1997, abandoned.

[51] **LOC (7) Cl.** **23-04**

[52] **U.S. Cl.** **D23/393; D23/263**

[58] **Field of Search** D23/393, 262, D23/263, 394; 285/424, 179.2, 183

DESCRIPTION

FIG. 1 is a perspective view thereof;
FIG. 2 is an end elevational view thereof;
FIG. 3 is a side elevational view thereof;
FIG. 4 is a top plan view thereof;
FIG. 5 is an end elevational view thereof from the opposite end of that shown in FIG. 2; and,
FIG. 6 is a bottom view of my design.
The opposite side elevational view is a mirror image of that shown in FIG. 3.

[56] **References Cited**

U.S. PATENT DOCUMENTS

D. 335,174 4/1993 Anderson D23/393

1 Claim, 1 Drawing Sheet

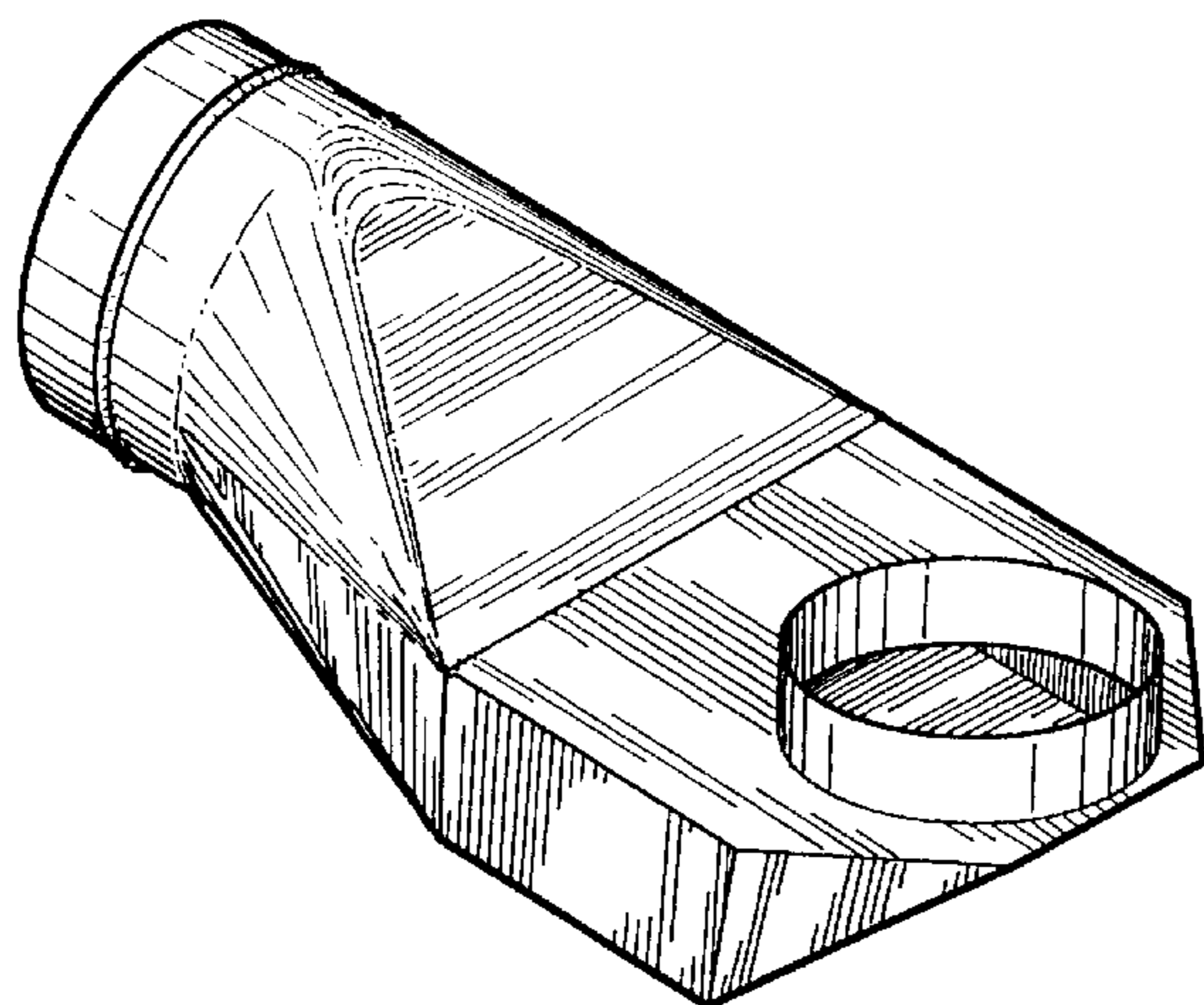

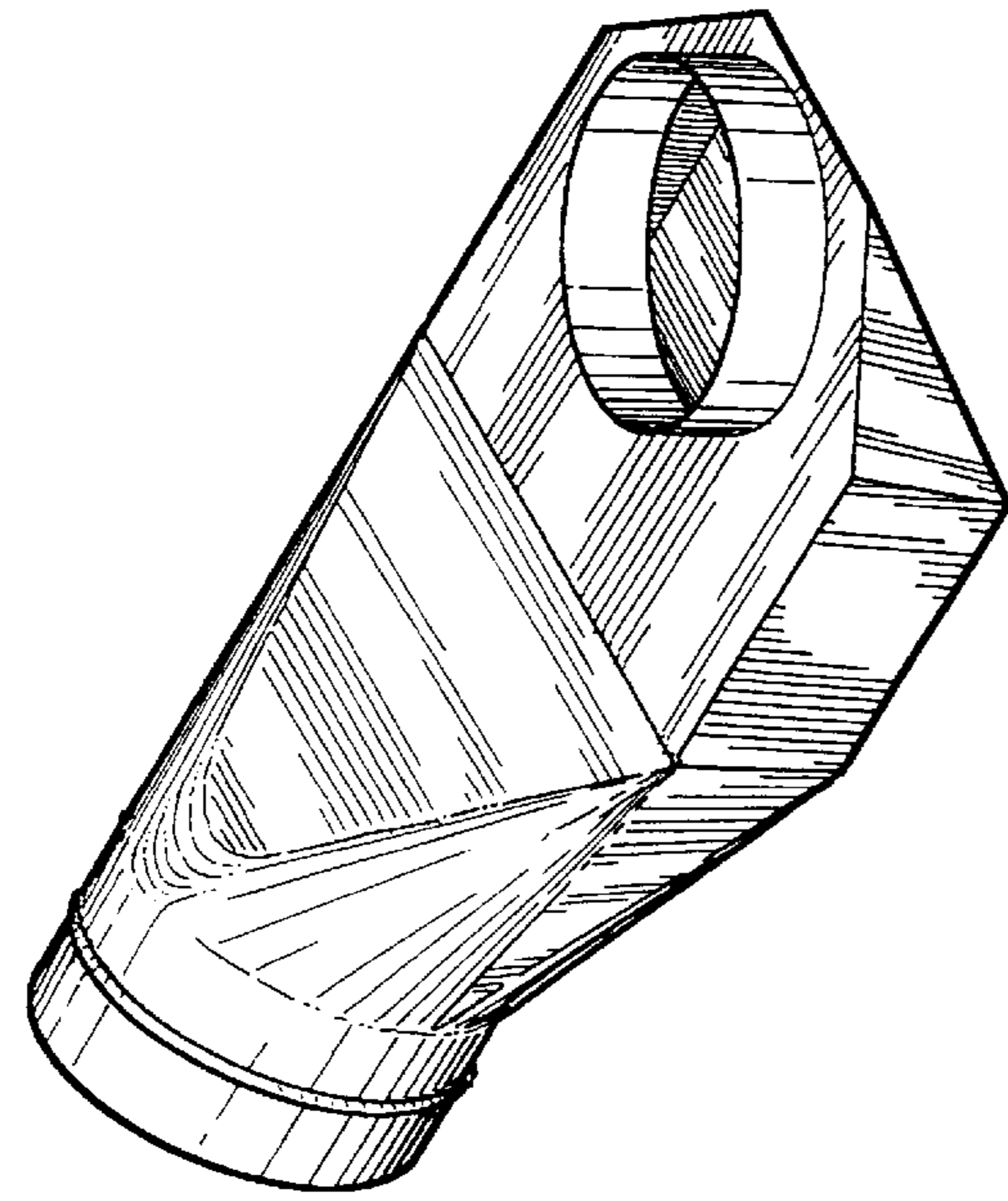

Fig. 1

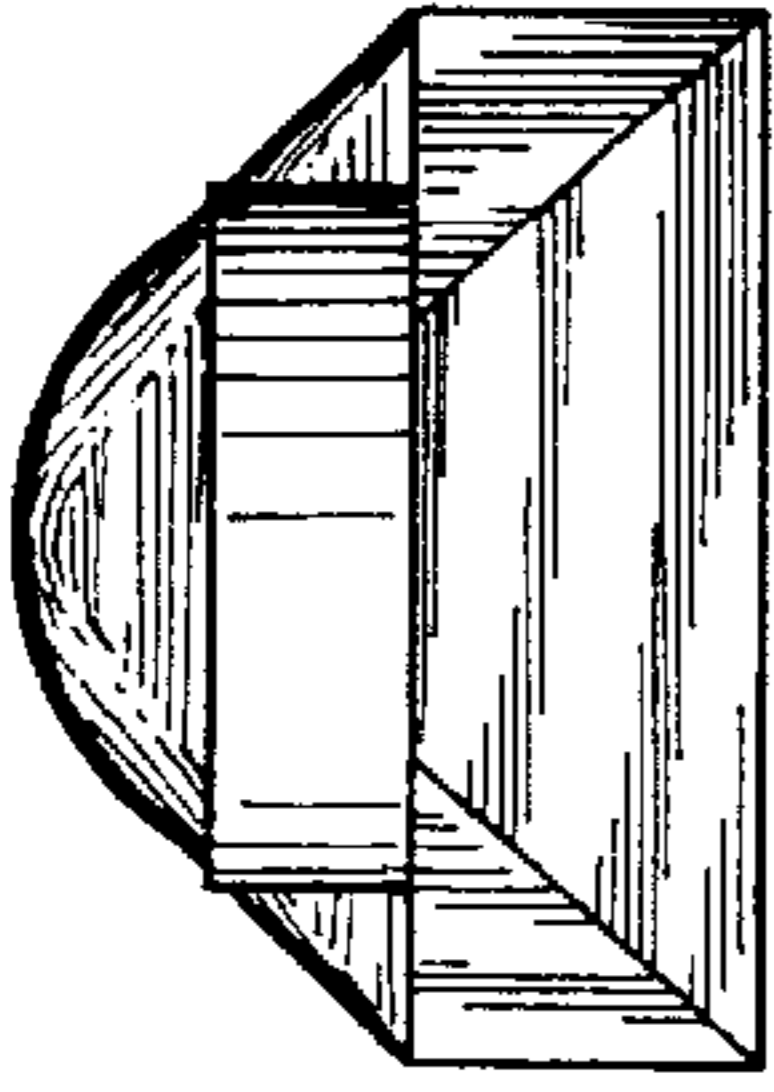

Fig. 2

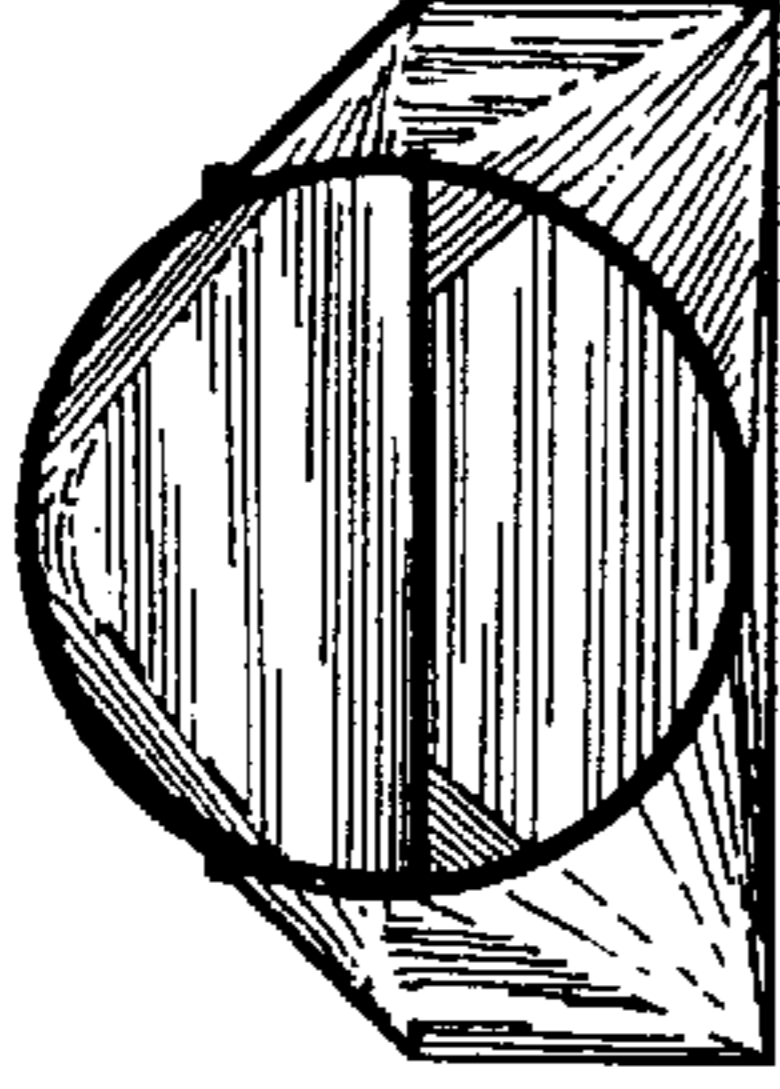

Fig. 5

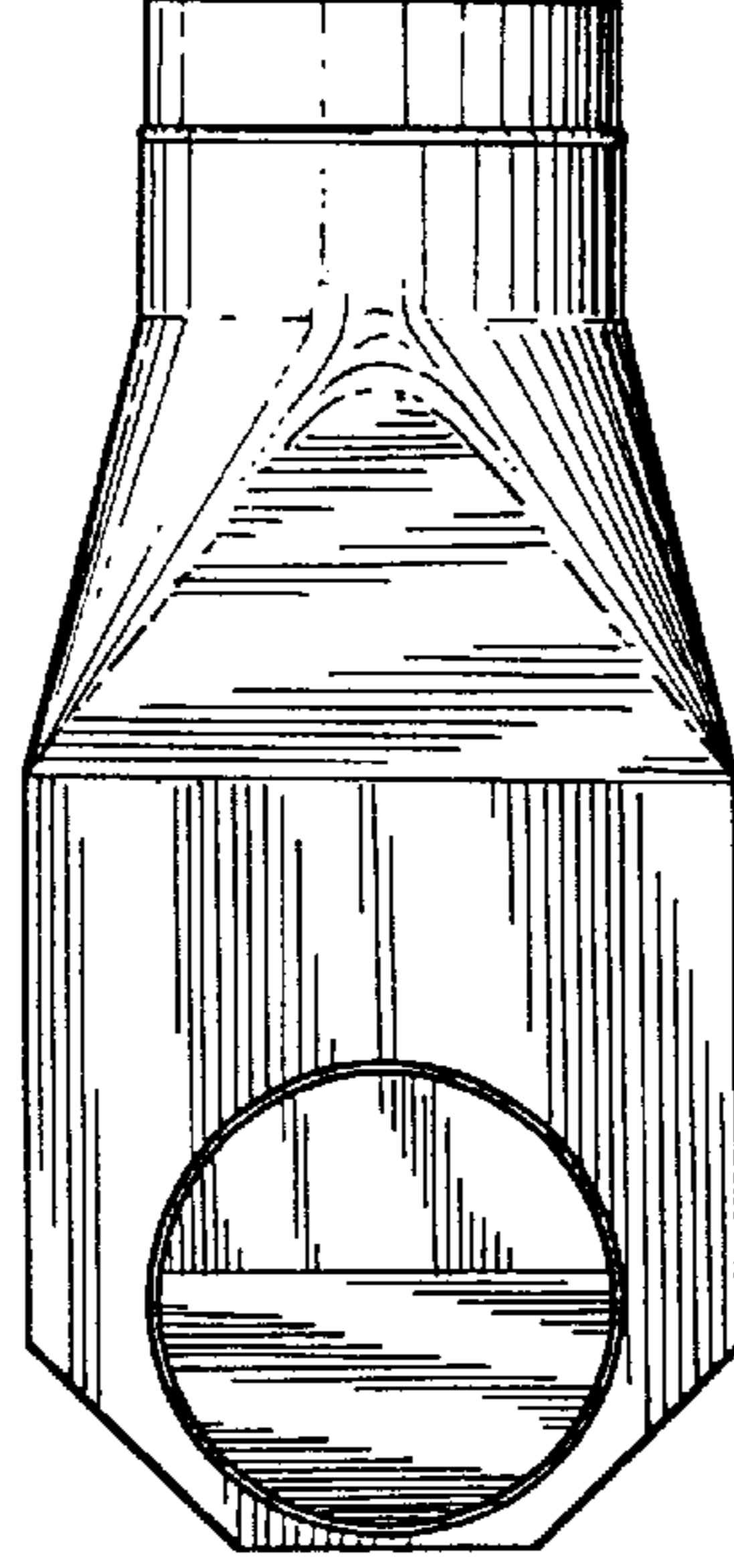

Fig. 4

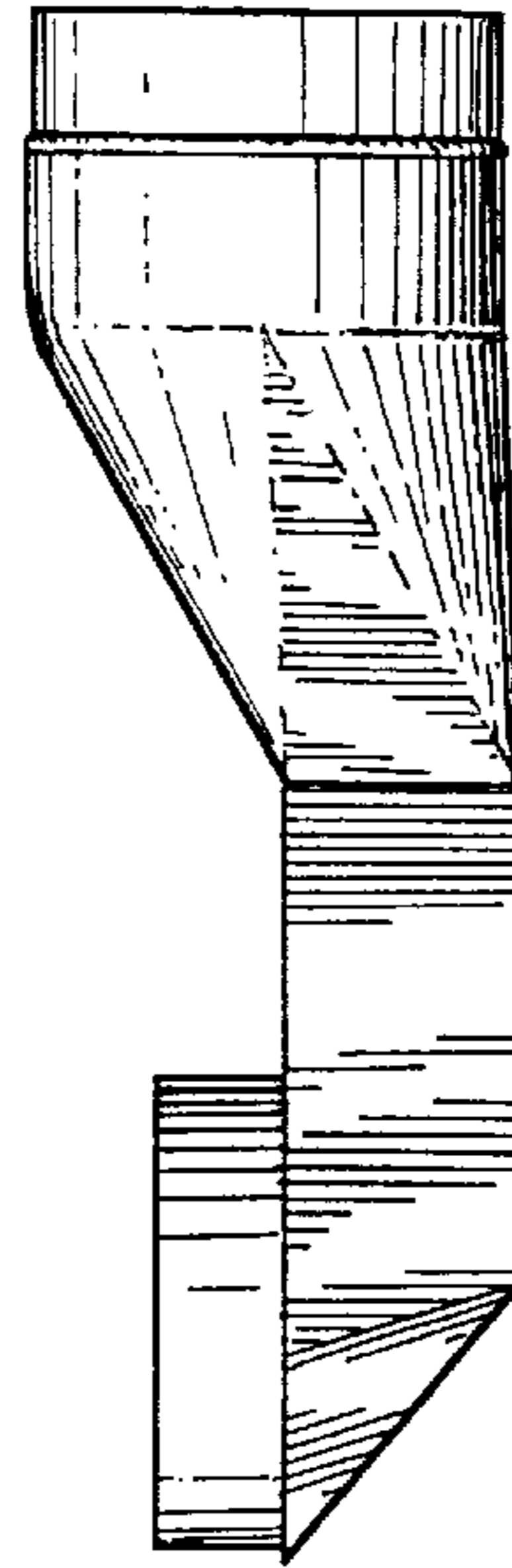

Fig. 3

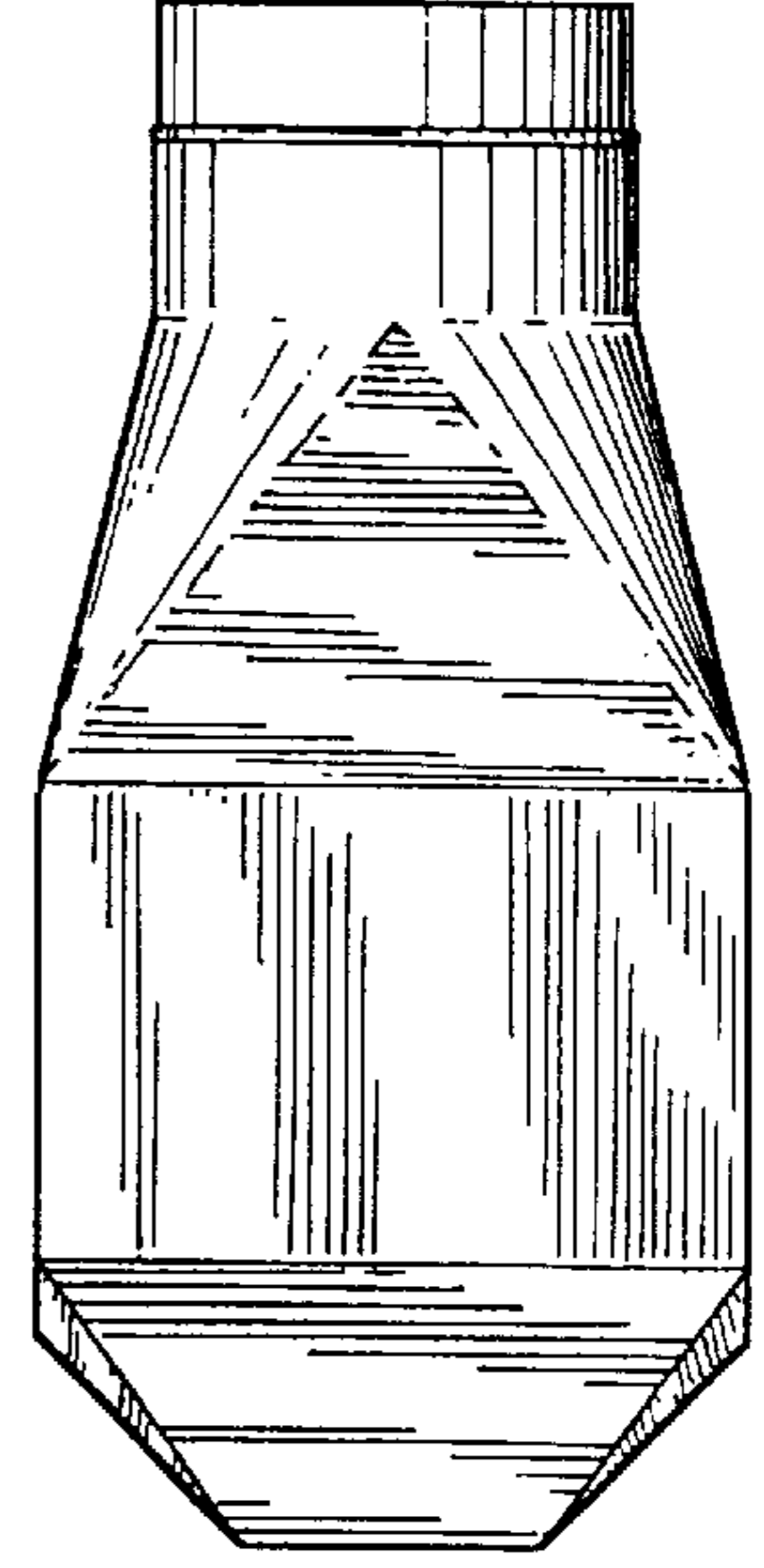

Fig. 6