



US00D425524S

United States Patent [19] Eriksen

[11] **Patent Number: Des. 425,524**

[45] **Date of Patent: ** May 23, 2000**

[54] **COMPRESSOR CASING**

[75] Inventor: **Steen Mandsfelt Eriksen**, Græsted, Denmark

[73] Assignee: **Active Tools A/S**, Stouby, Denmark

[**] Term: **14 Years**

[21] Appl. No.: **29/104,773**

[22] Filed: **May 12, 1999**

[30] **Foreign Application Priority Data**

Nov. 13, 1998 [DK] Denmark MA 1998 01208

[51] **LOC (7) Cl.** **15-01**

[52] **U.S. Cl.** **D15/9**

[58] **Field of Search** D15/7-9; 366/605; 417/234, 415, 411, 410.3; D26/38; 401/196, 197, 203, 204, 218, 219; D24/8

[56] **References Cited**

U.S. PATENT DOCUMENTS

D. 327,274 6/1992 Matre' et al. D15/7

D. 338,208 8/1993 Reents et al. D15/9
D. 340,458 10/1993 Wang D15/7
D. 340,724 10/1993 Mariol D15/7
D. 374,237 10/1996 Wang D15/7

Primary Examiner—Ralf Seifert
Attorney, Agent, or Firm—Lee, Mann, Smith, McWilliams, Sweeney & Ohlson

[57] **CLAIM**

The ornamental design for a compressor casing, as shown and described.

DESCRIPTION

FIG. 1 is a prospective view of a compressor casing according to my invention.
FIG. 2 is a front elevational illustration thereof.
FIG. 3 is a rear elevational illustration thereof.
FIG. 4 is a top plan view thereof.
FIG. 5 is a bottom plan view thereof.
FIG. 6 is an end elevational illustration of the right end in relation to FIGS. 1A and 1B; and,
FIG. 7 is an end elevational illustration of the end opposite to FIG. 1F.

1 Claim, 7 Drawing Sheets

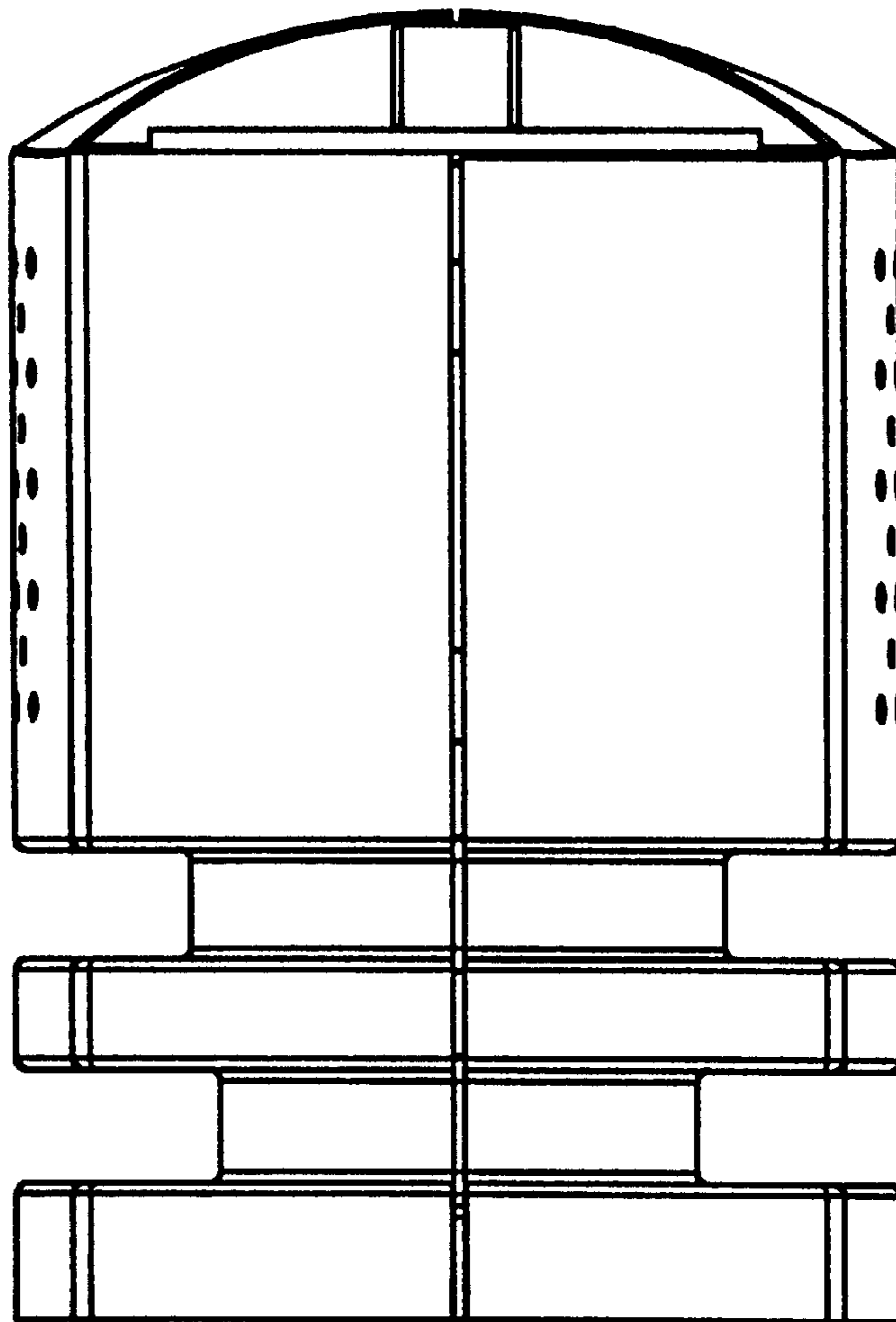

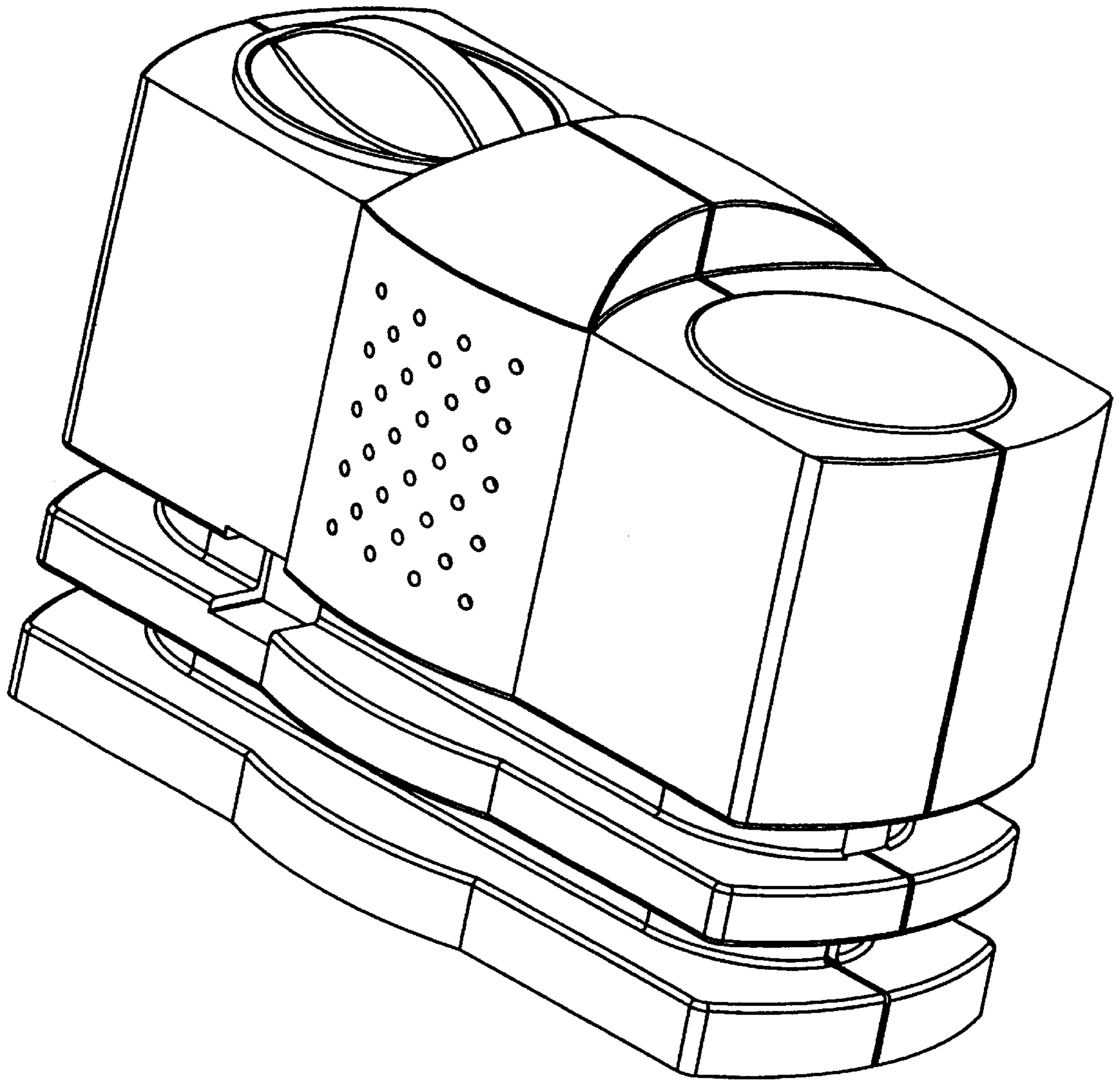

Fig. 1

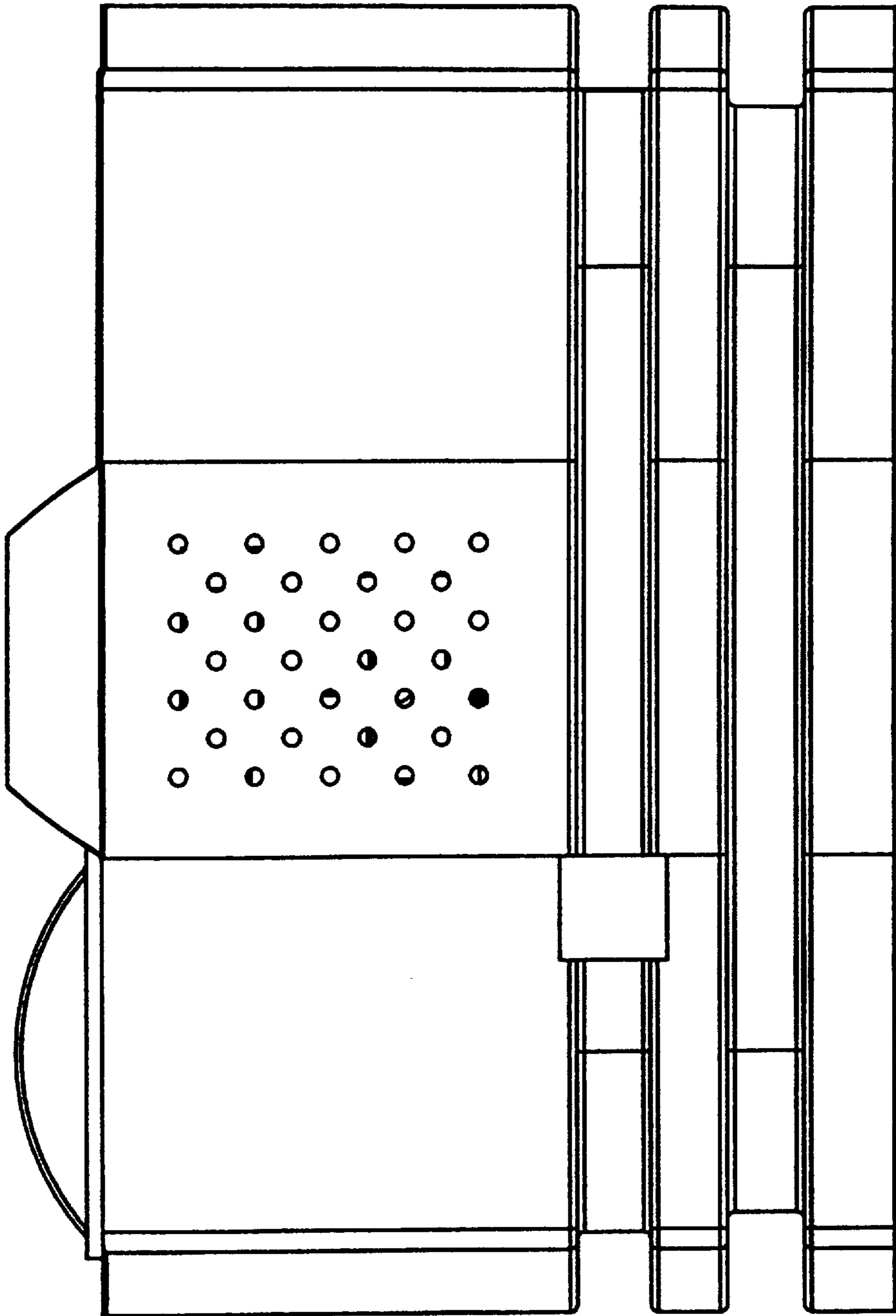

Fig. 2

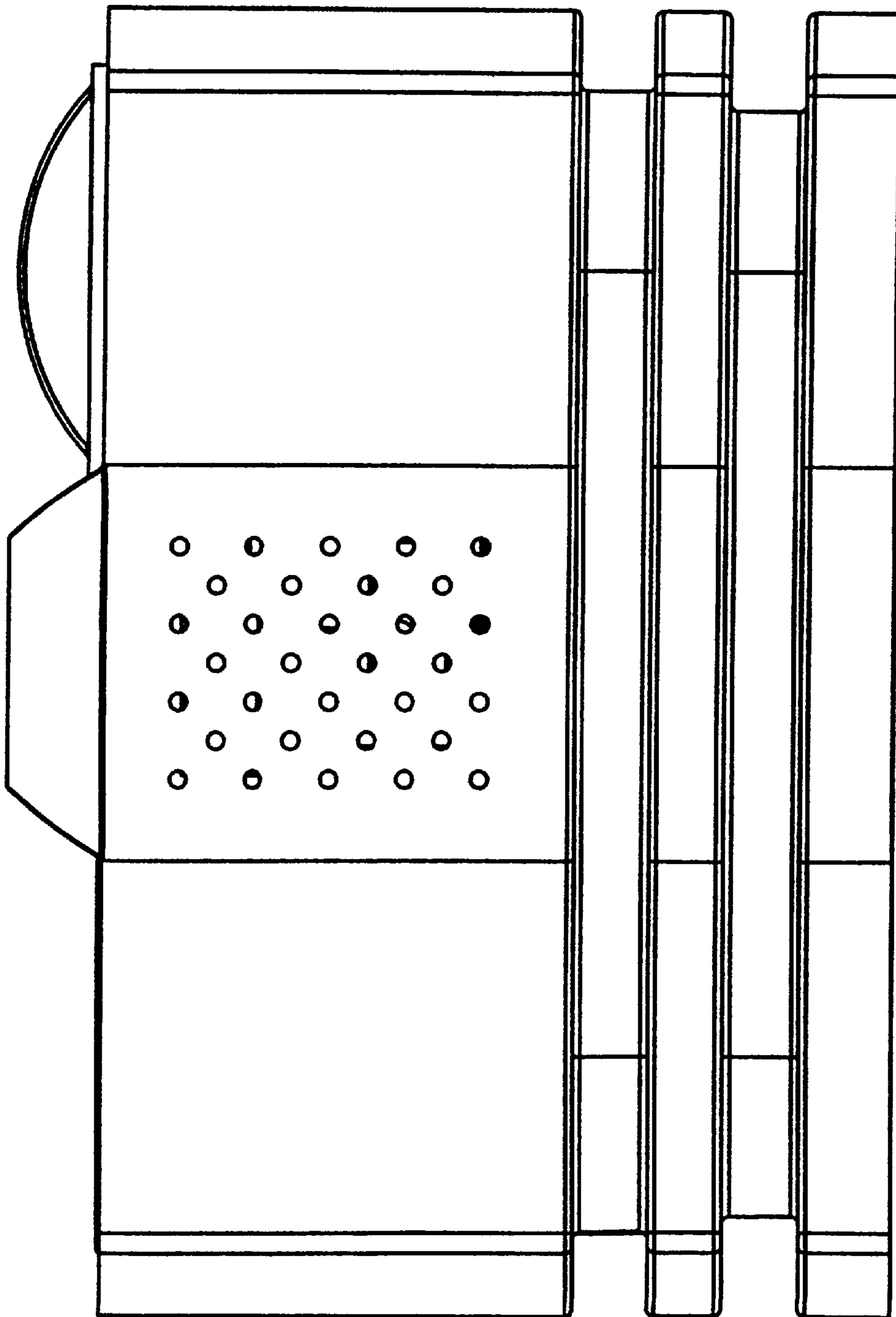

Fig. 3

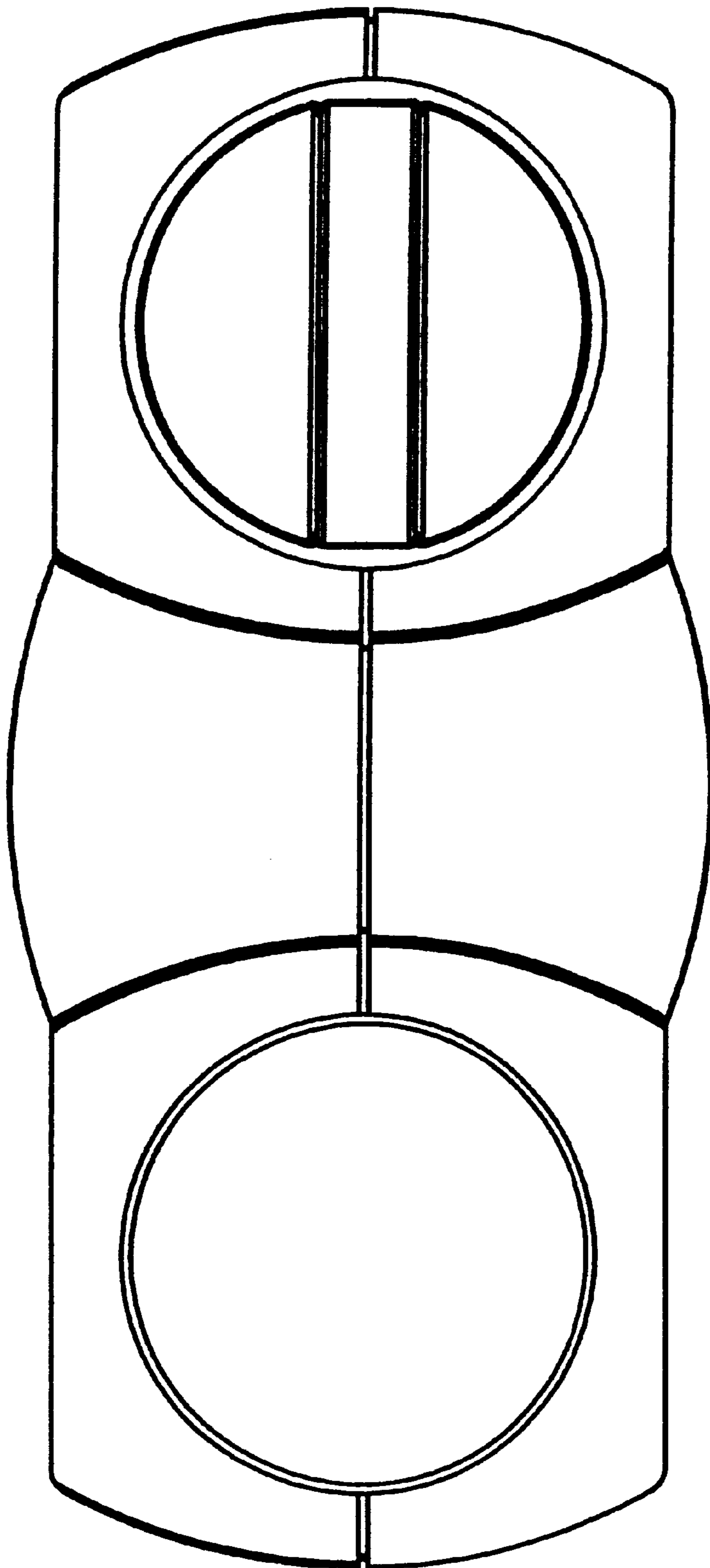

Fig. 4

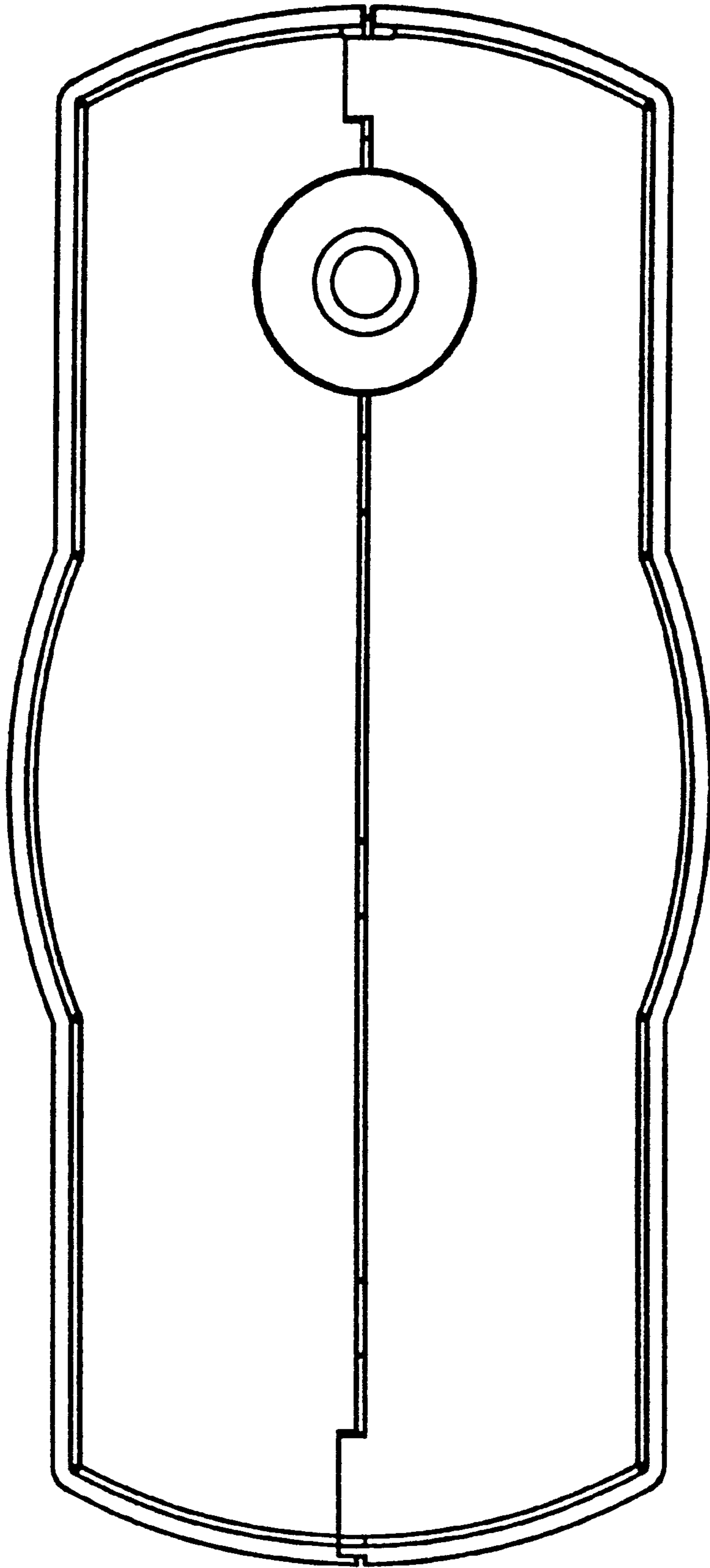

Fig. 5

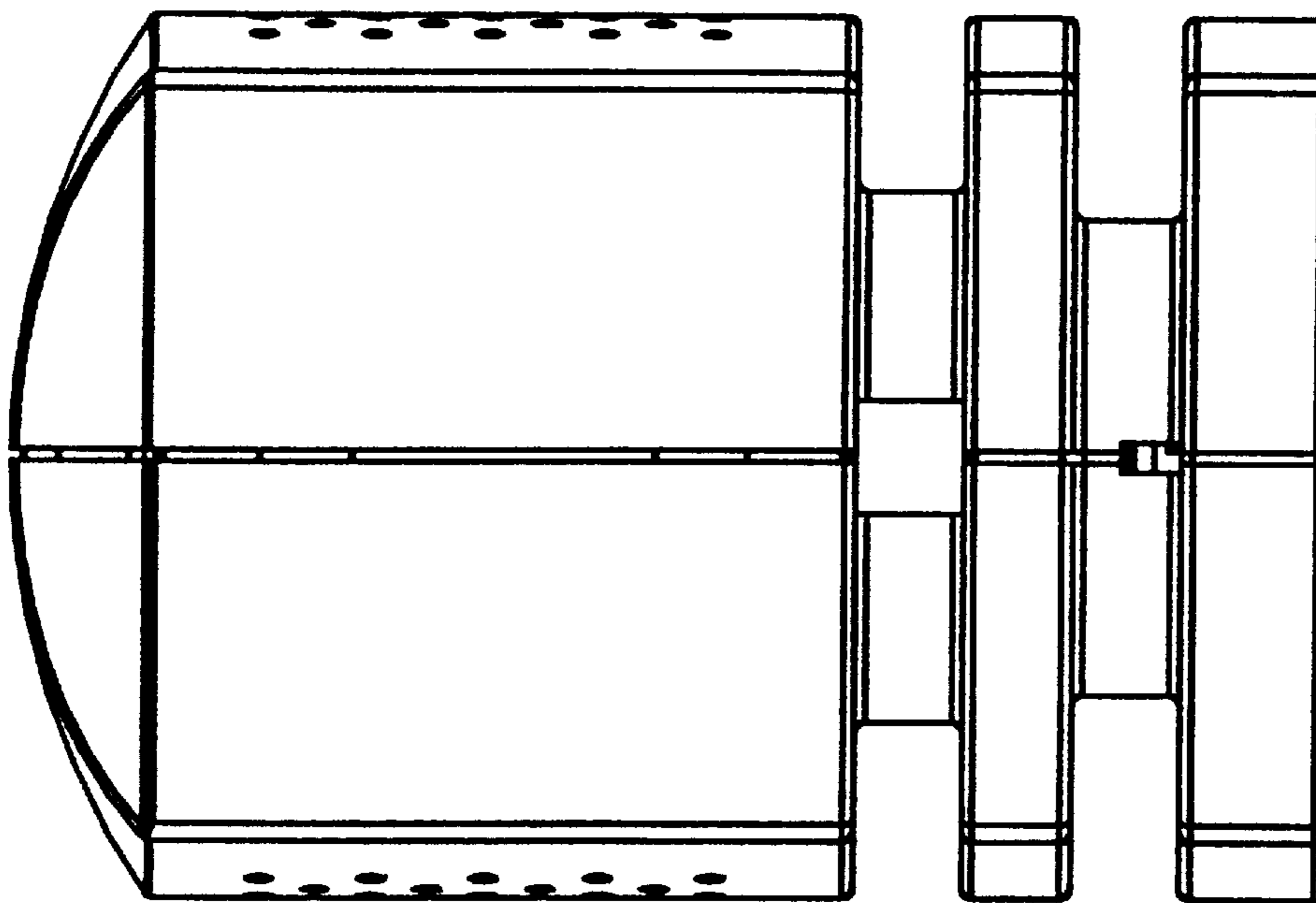

Fig. 6

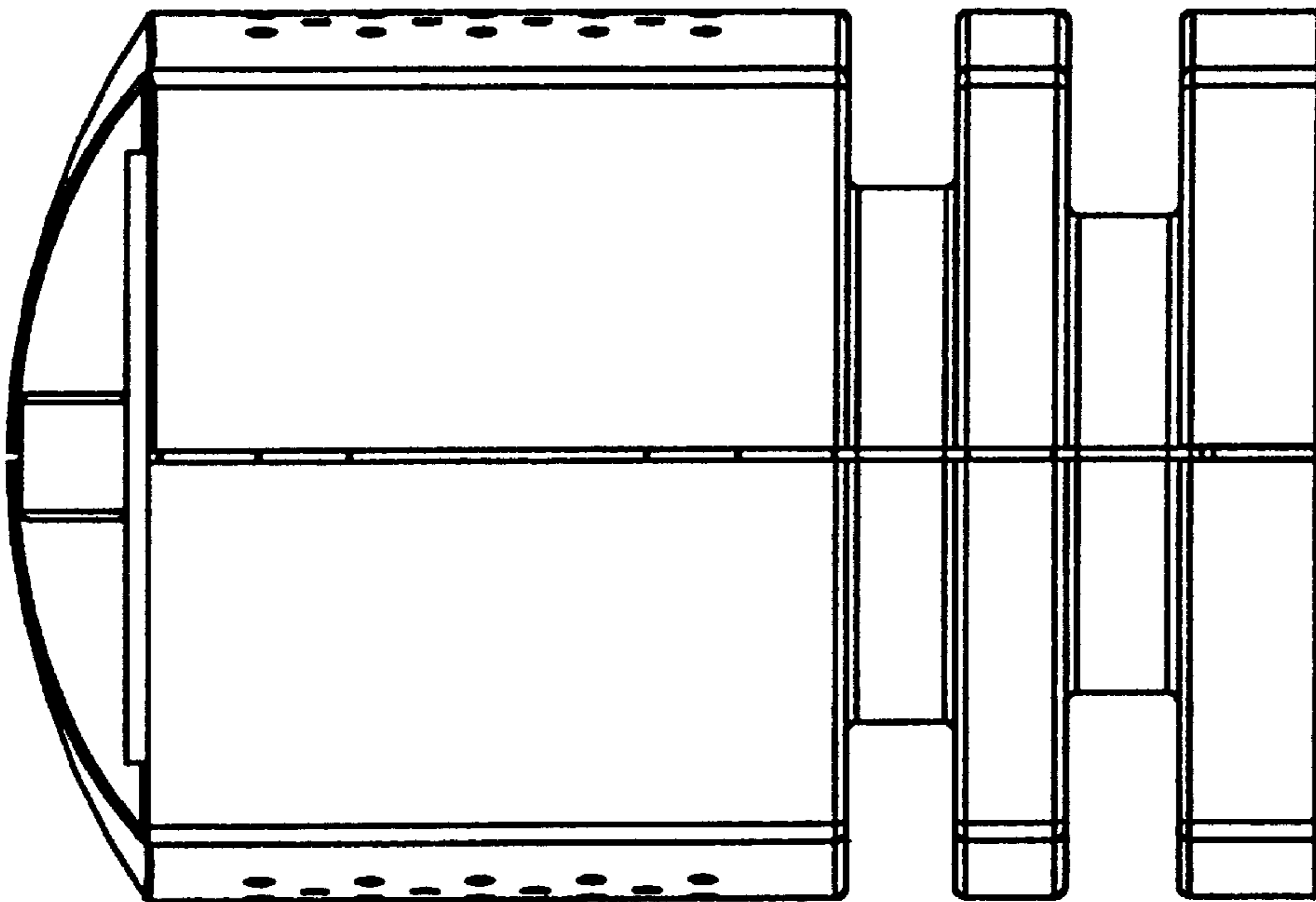

Fig. 7