



US00D425515S

United States Patent [19] Suh

[11] Patent Number: **Des. 425,515**

[45] Date of Patent: **** May 23, 2000**

[54] **ANTENNA ORNAMENT**

[76] Inventor: **Young Suh**, 10371 Garden Grove Blvd., Garden Grove, Calif. 92843

[**] Term: **14 Years**

[21] Appl. No.: **29/111,832**

[22] Filed: **Oct. 5, 1999**

[51] **LOC (7) Cl.** **14-03**

[52] **U.S. Cl.** **D14/232**; D21/659; D29/106

[58] **Field of Search** D14/230-238; D12/197-201, 162; 428/542.2, 542.4; D11/157; D29/102-106; 2/425; D21/658-660; D2/865, 872, 882; 343/711-714, 720; 116/28 R

[56] **References Cited**

U.S. PATENT DOCUMENTS

D. 209,219	11/1967	Goldstein et al.	D11/157
D. 317,890	7/1991	Bachmann	D12/162
D. 332,507	1/1993	Anderson	D29/106
D. 353,819	12/1994	Klarich	D14/230
D. 359,018	6/1995	Thigpen	D12/162
D. 383,137	9/1997	Gamble, Jr. et al.	D14/230
D. 383,953	9/1997	DeFilippo	D29/106
D. 390,567	2/1998	Gamble, Jr. et al.	D14/230

4,972,795 11/1990 Mace 116/28 R
5,176,099 1/1993 Katz et al. 116/209

Primary Examiner—Louis S. Zarfes
Assistant Examiner—G. Andoll
Attorney, Agent, or Firm—Goldstein & Canino

[57] **CLAIM**

The ornamental design for an antenna ornament, as shown and described.

DESCRIPTION

FIG. 1 is a diagrammatic front elevational view of an antenna ornament showing my new design in full lines with a car shown in broken lines representing environmental matter being for illustrative purposes only and forming no part of the claimed invention.

FIG. 2 is a front elevational view of the antenna ornament of FIG. 1, on an enlarged scale.

FIG. 3 is a rear elevational view thereof.

FIG. 4 is a left side elevational view of the antenna ornament, the right side elevational view being a mirror image of the left side view.

FIG. 5 is a top plan view thereof; and,

FIG. 6 is a bottom plan view thereof.

1 Claim, 2 Drawing Sheets

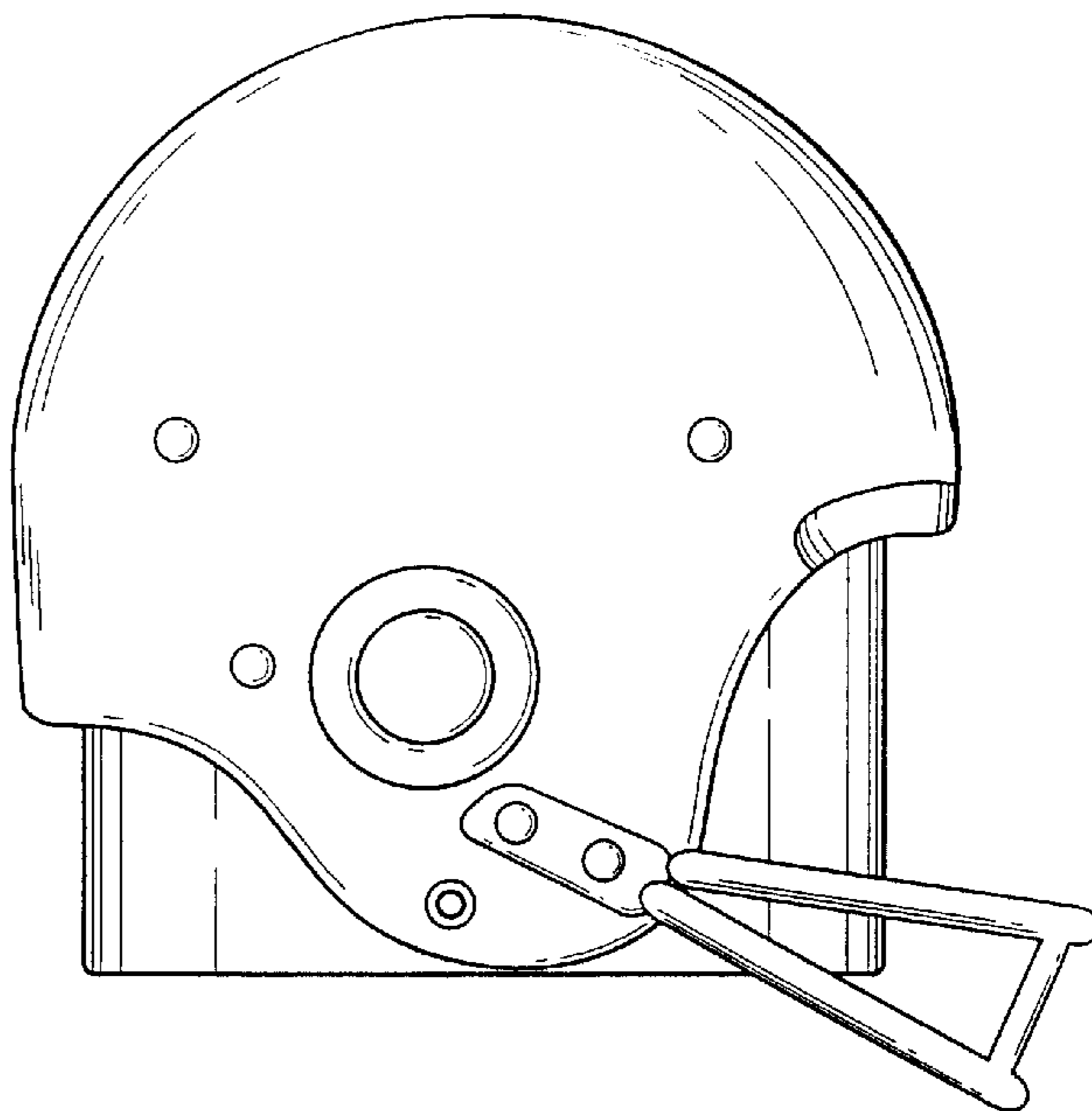
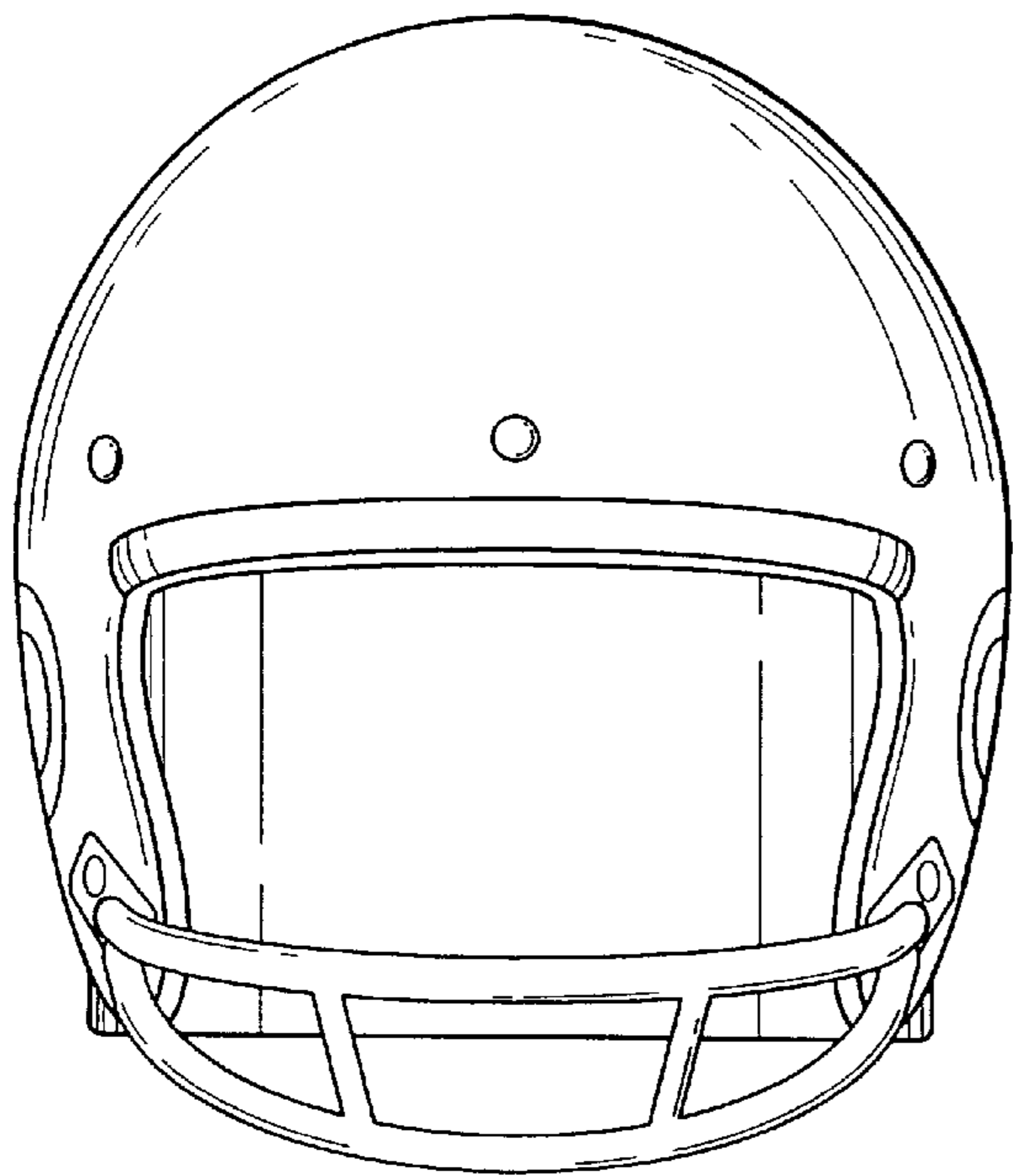

FIG. 1

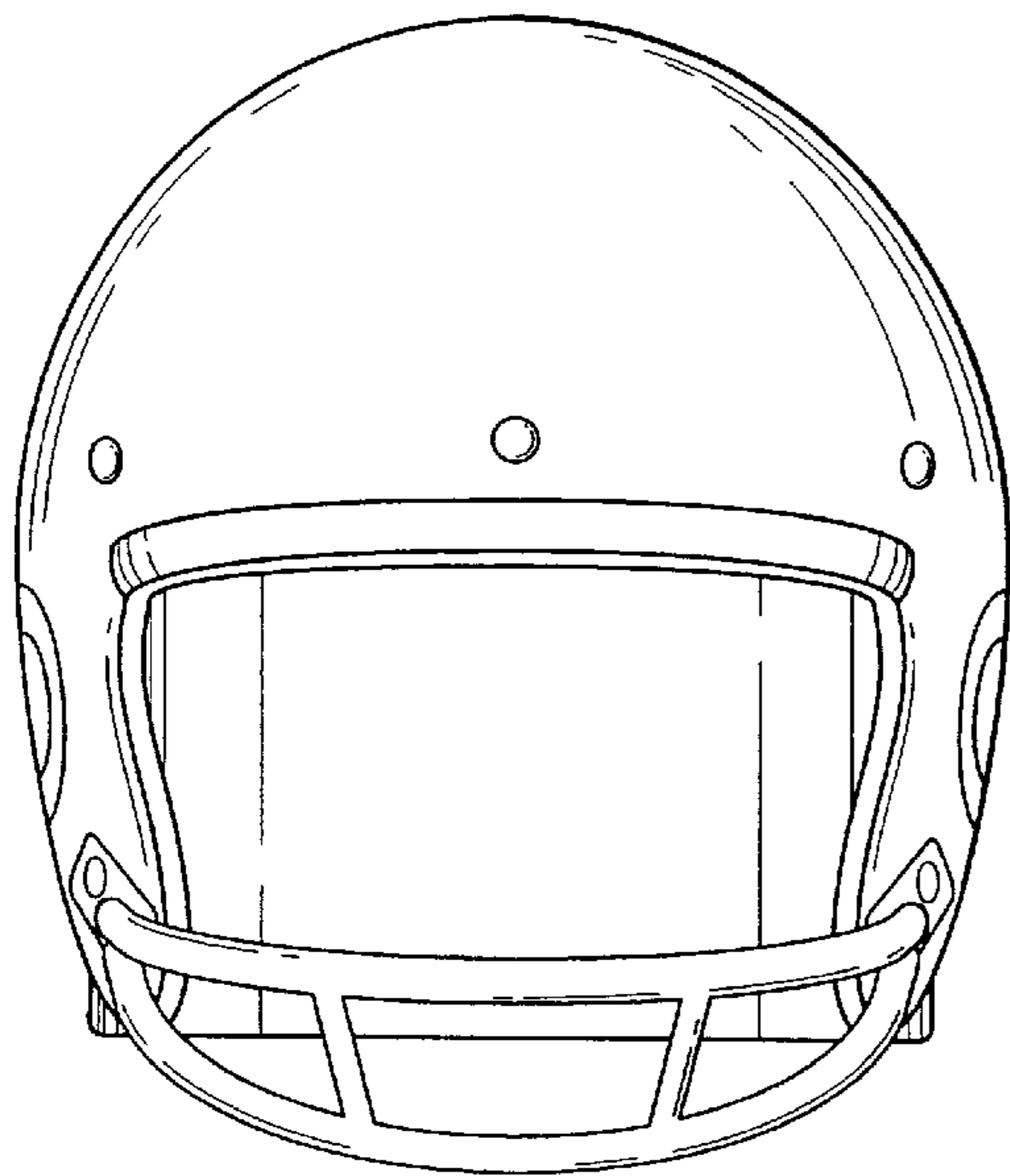
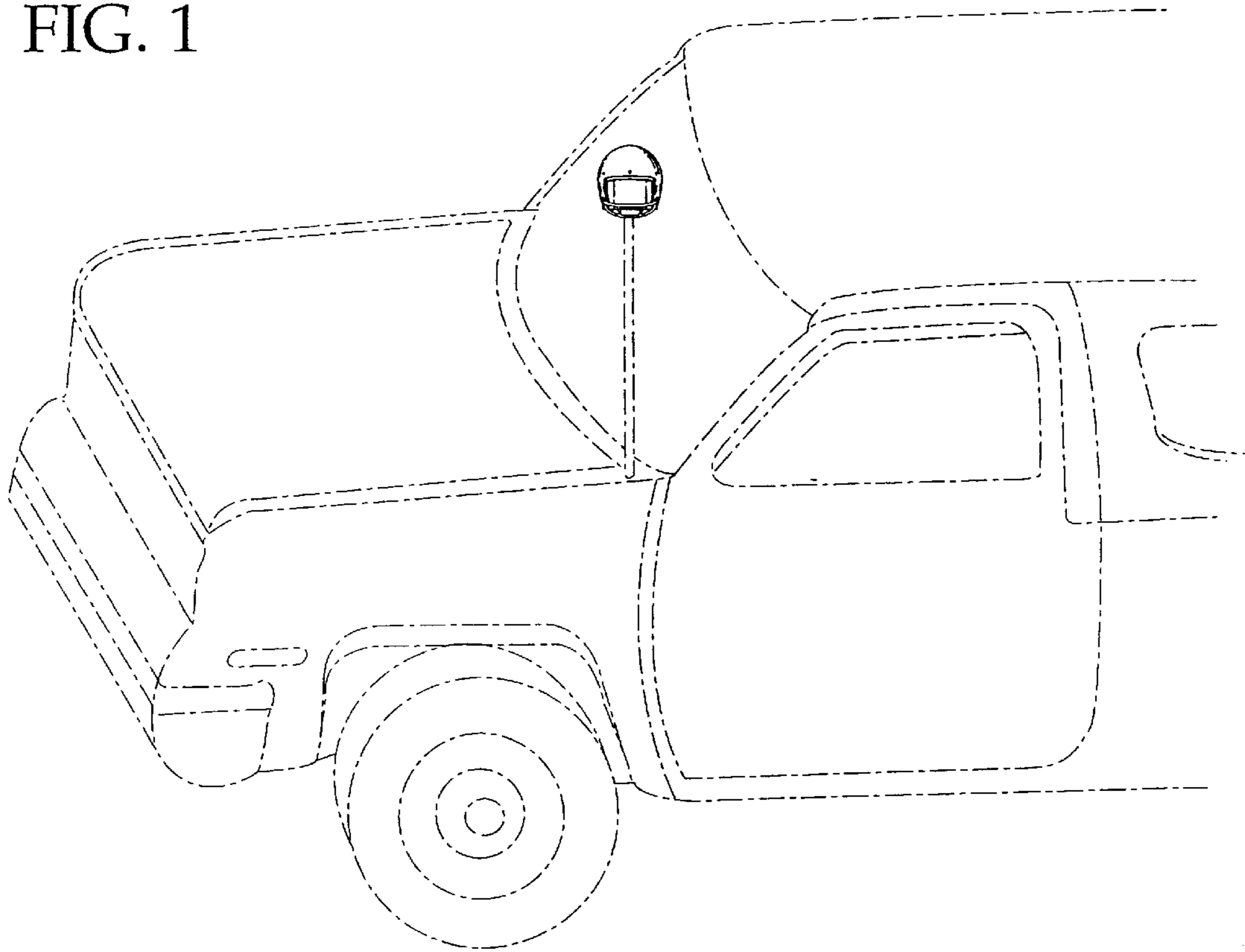

FIG. 2

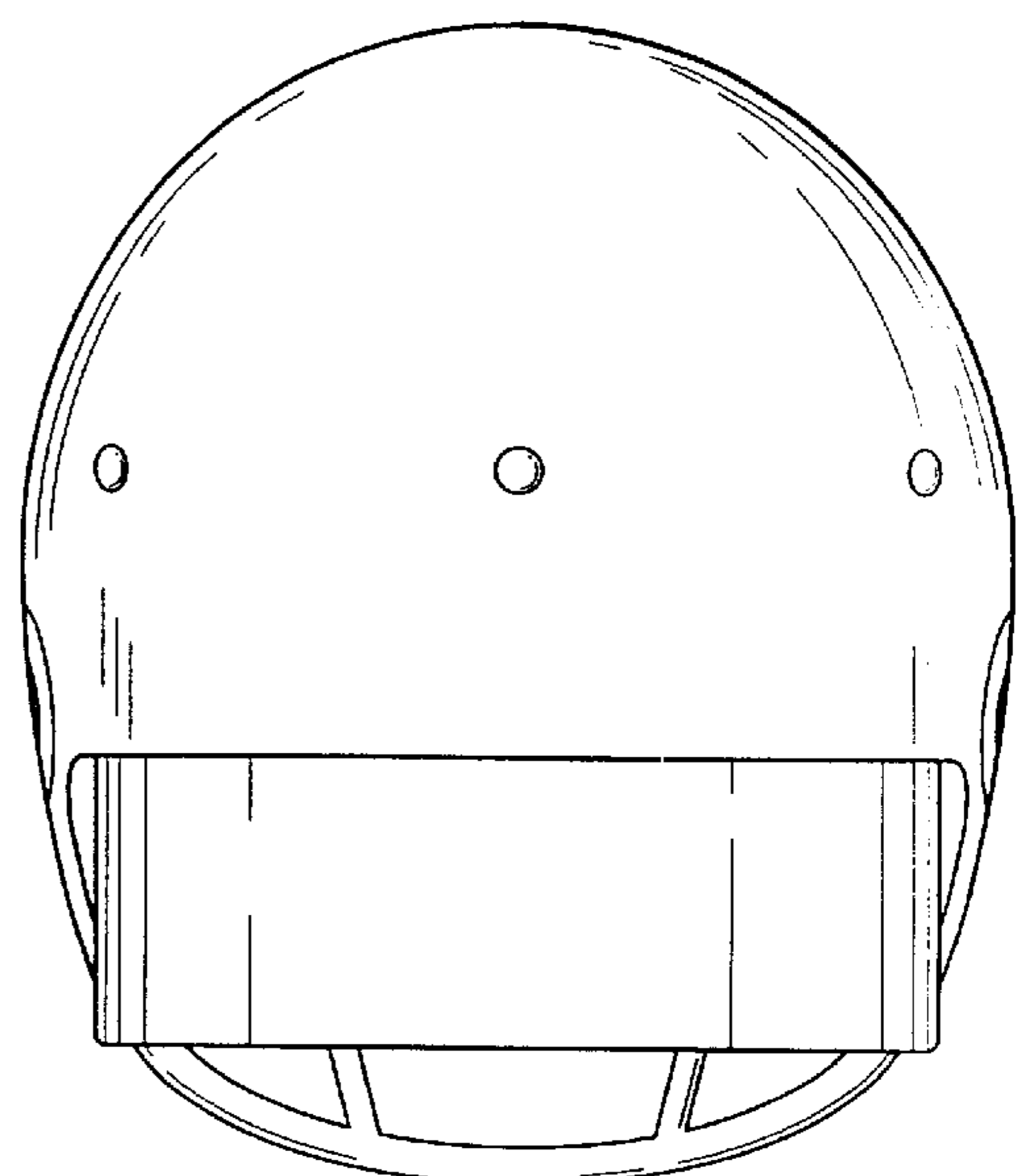

FIG. 3

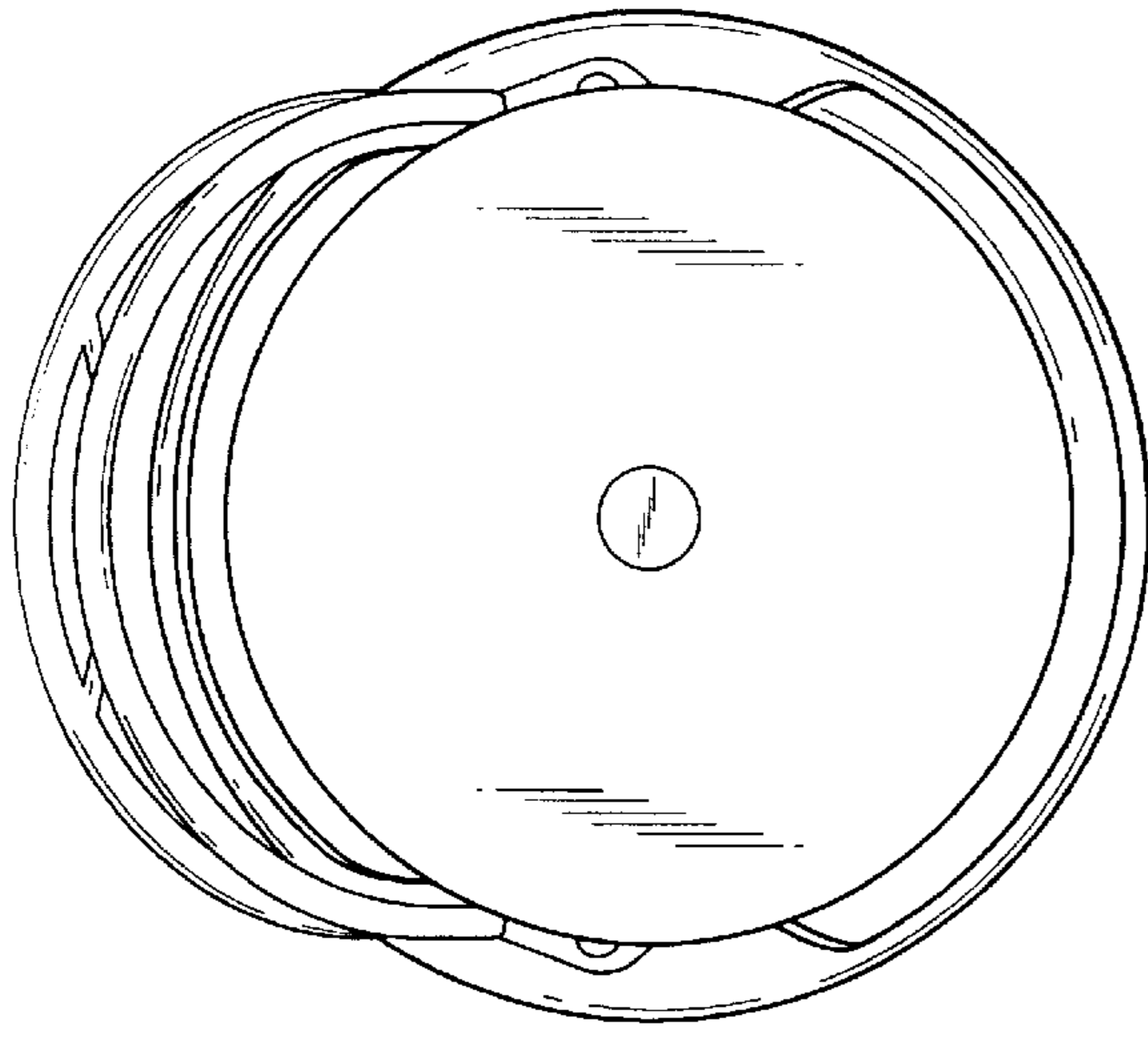

FIG. 5

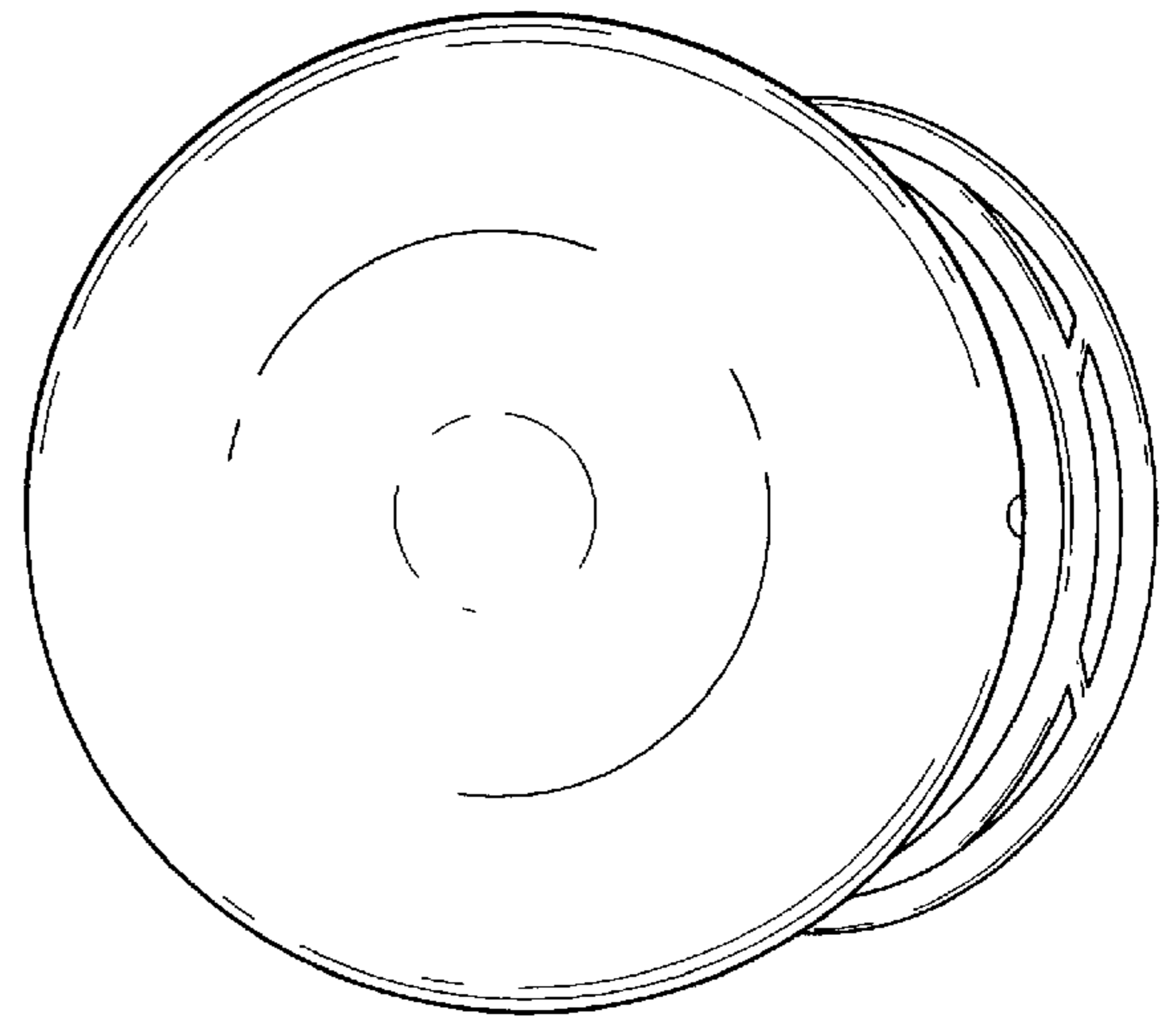

FIG. 6

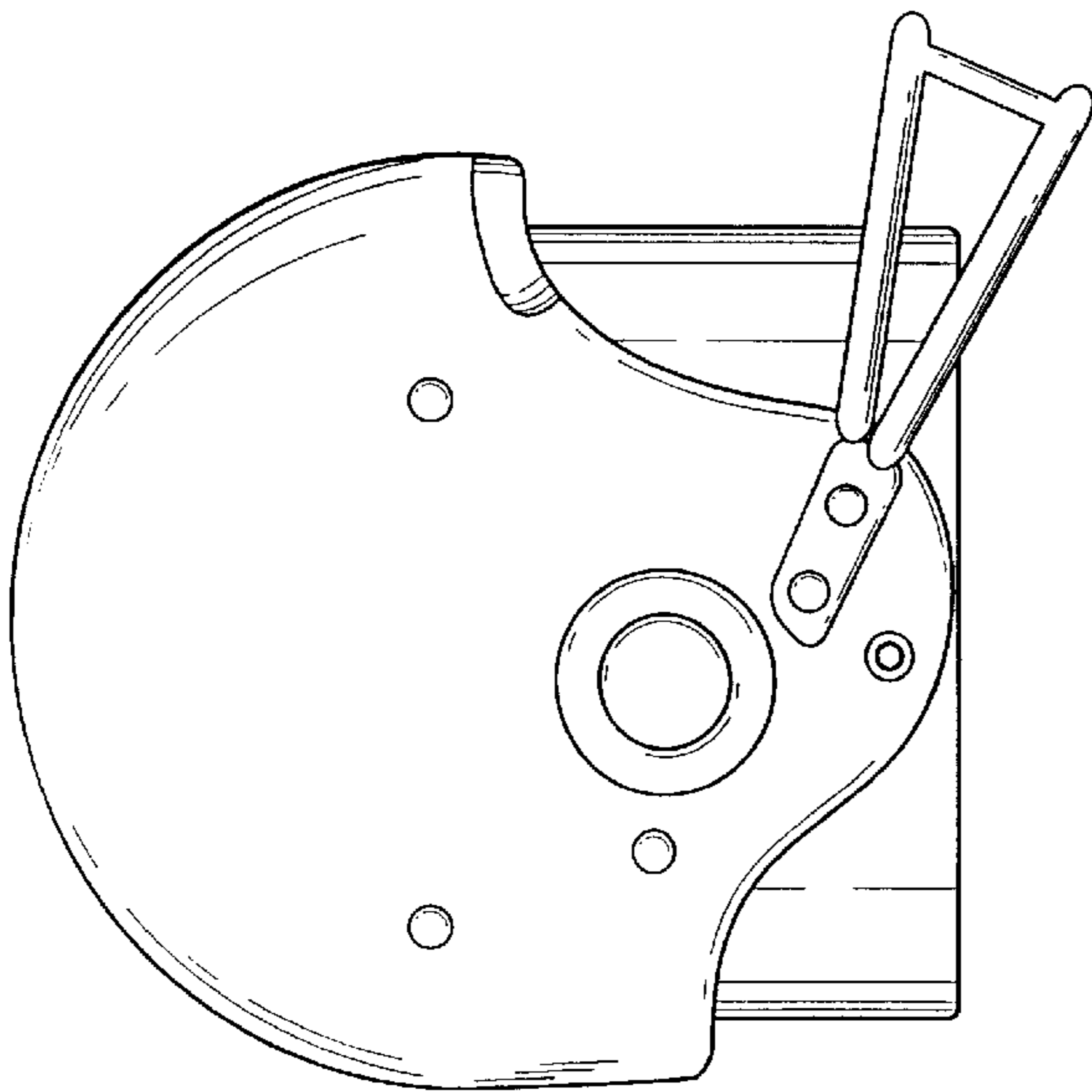

FIG. 4