



US00D425420S

United States Patent [19]

Klima, Jr. et al.

[11] Patent Number: **Des. 425,420**

[45] Date of Patent: **** *May 23, 2000**

[54] **CONCENTRATE CARTRIDGE**

[75] Inventors: **Walter F. Klima, Jr.**, Traveler's Rest, S.C.; **William L. Klima**, Spotsylvania, Va.

[73] Assignee: **Sprayex, Inc.**, Travelers Rest, S.C.

[*] Notice: This patent is subject to a terminal disclaimer.

[**] Term: **14 Years**

[21] Appl. No.: **29/097,556**

[22] Filed: **Dec. 9, 1998**

[51] LOC (7) Cl. **09-07**

[52] U.S. Cl. **D9/448**

[58] Field of Search D9/434, 448; 141/18, 141/19; 222/129-130, 383.1, 82; 239/304-5, 309

[56] **References Cited**

U.S. PATENT DOCUMENTS

D. 378,663 4/1997 Daansen D9/448

4,793,476	12/1988	Schrupp	239/309
5,125,534	6/1992	Rose et al.	222/129
5,275,310	1/1994	Mielnik et al.	222/130
5,529,216	6/1996	Klima et al.	222/130

Primary Examiner—Robin V. Taylor
Attorney, Agent, or Firm—Klima & Pezzlo, P.C.

[57] **CLAIM**

The ornamental design for a concentrate cartridge, as shown and described.

DESCRIPTION

FIG. 1 is a perspective view of the present invention. FIG. 2 is a side elevational view. FIG. 3 is a top planar view. FIG. 4 is a bottom planar view. FIG. 5 is a center vertical cross sectional elevational view of the concentrate cartridge as indicated in FIG. 3; and, FIG. 6 is a center vertical cross-sectional view of the concentrate cartridge as indicated in FIG. 3.

1 Claim, 2 Drawing Sheets

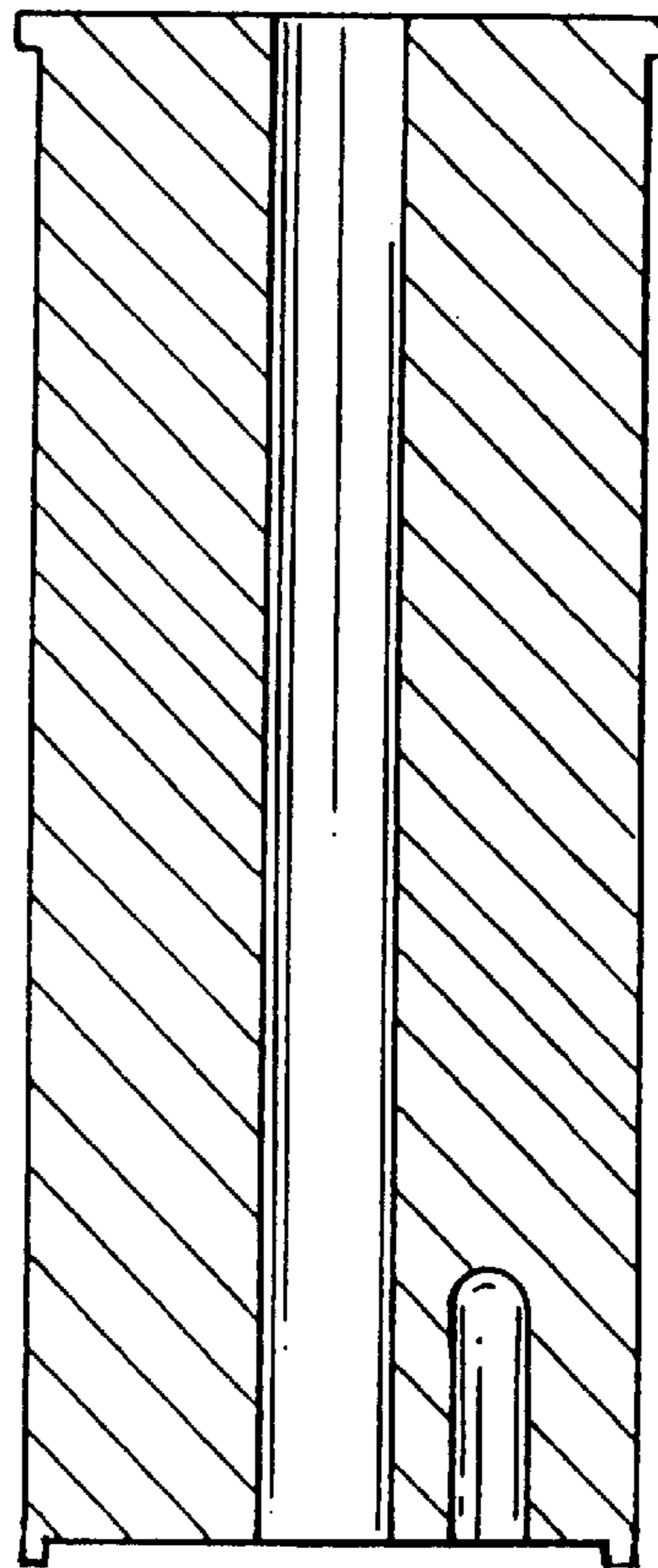
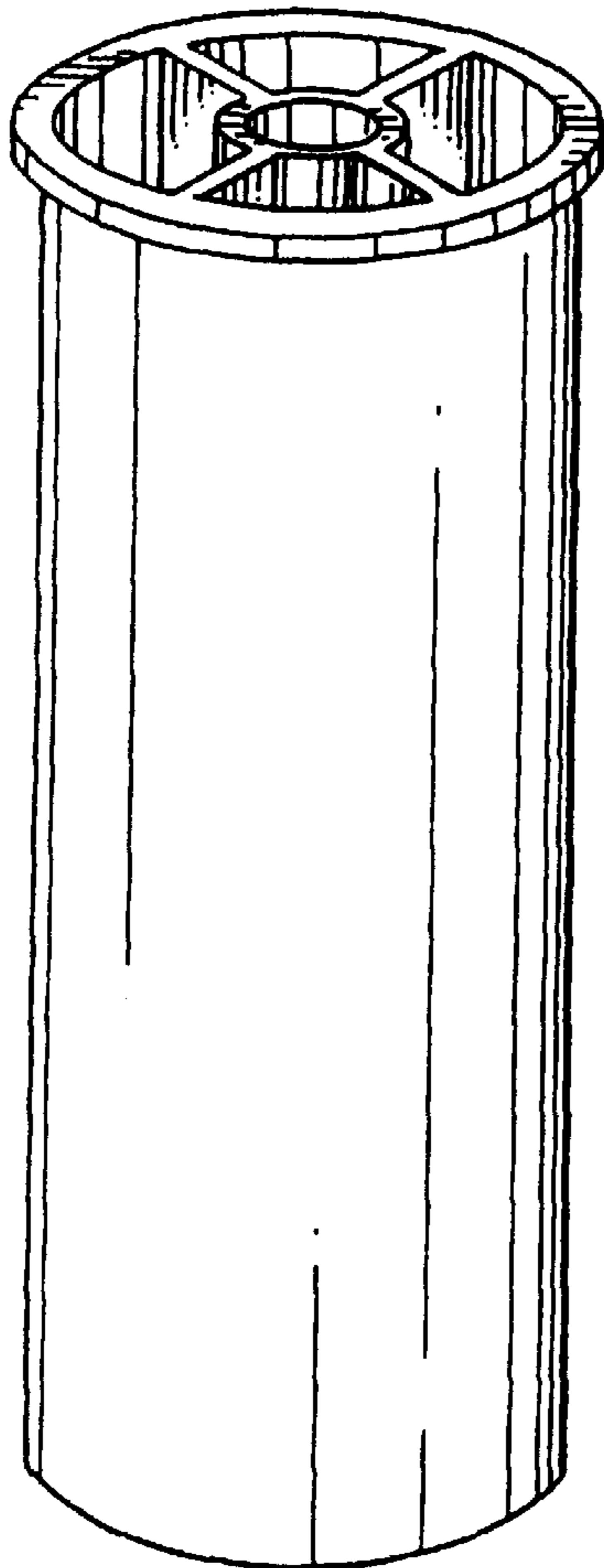

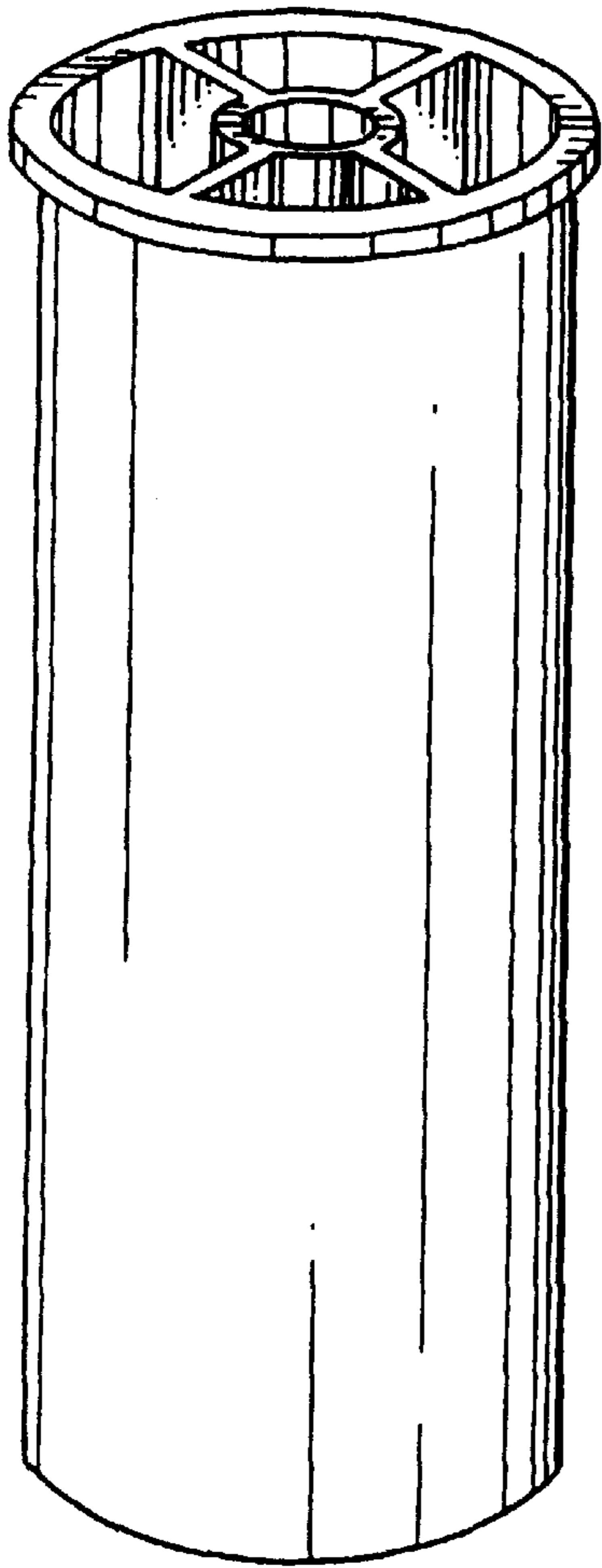

FIG. 1

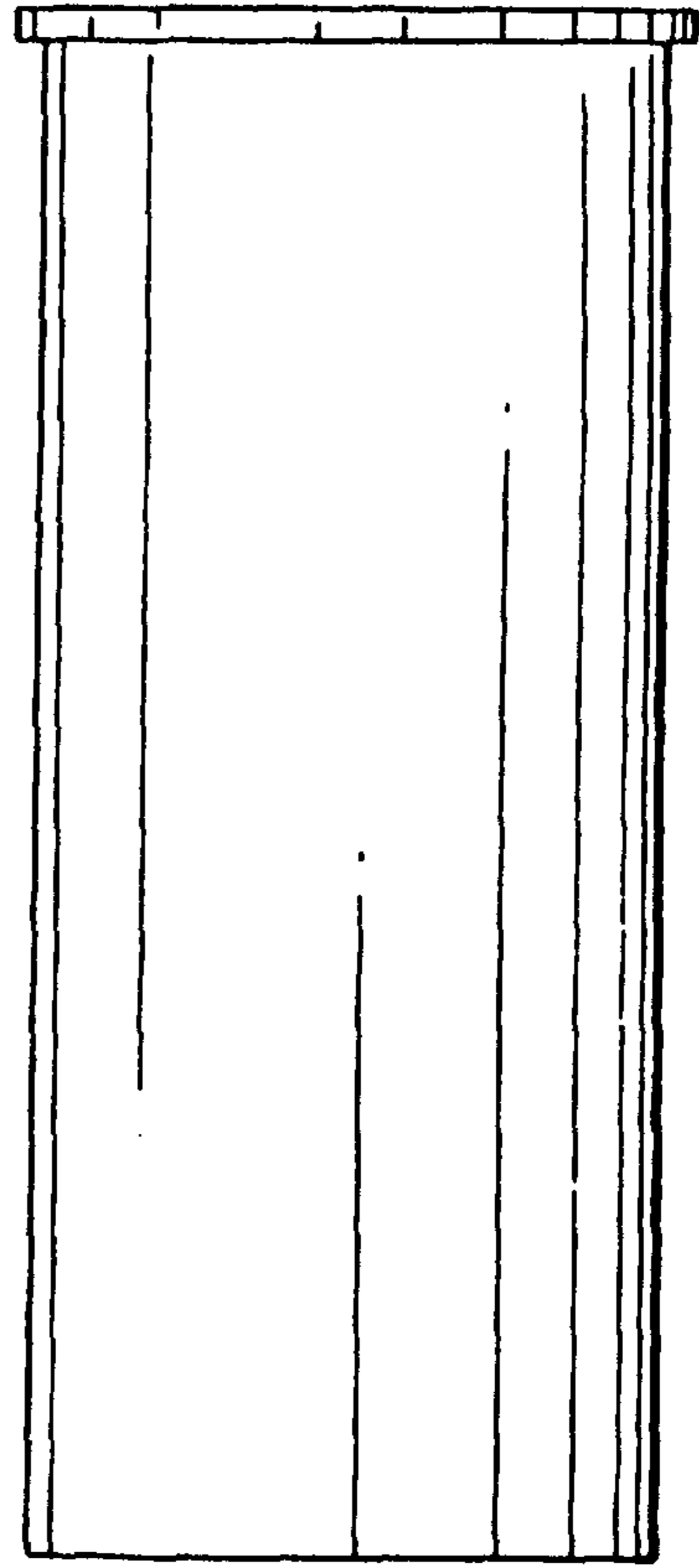

FIG. 2

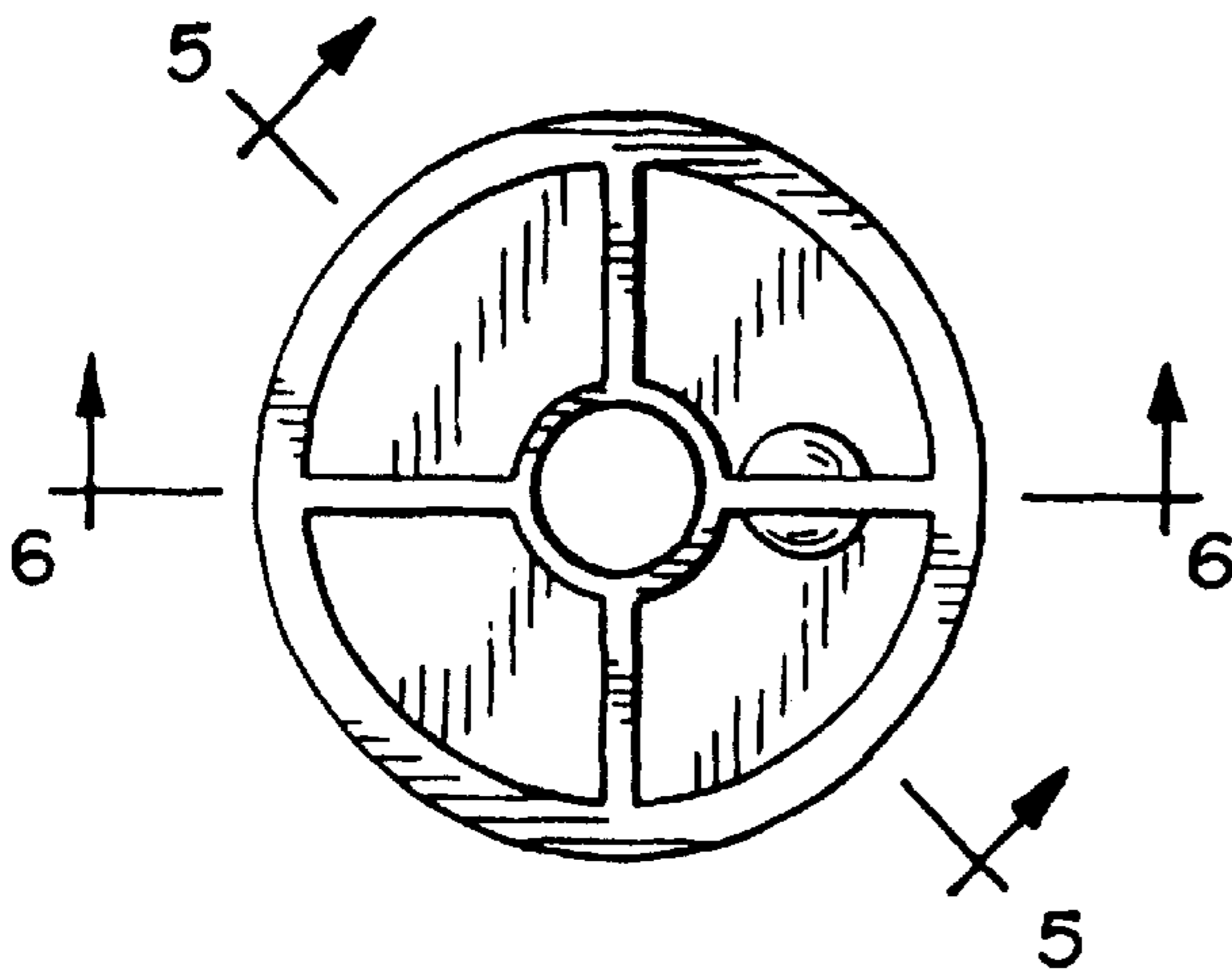

FIG. 3

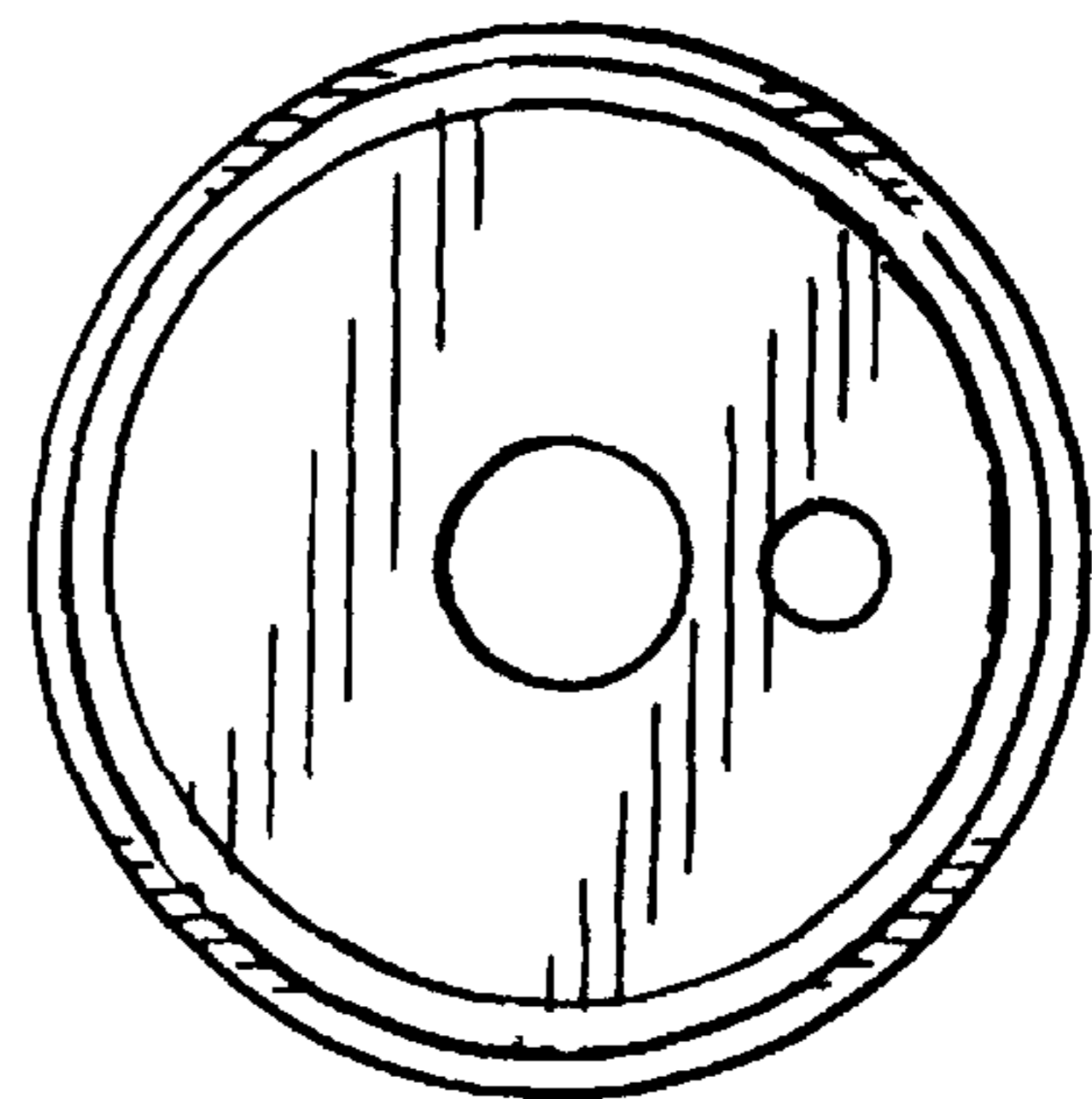

FIG. 4

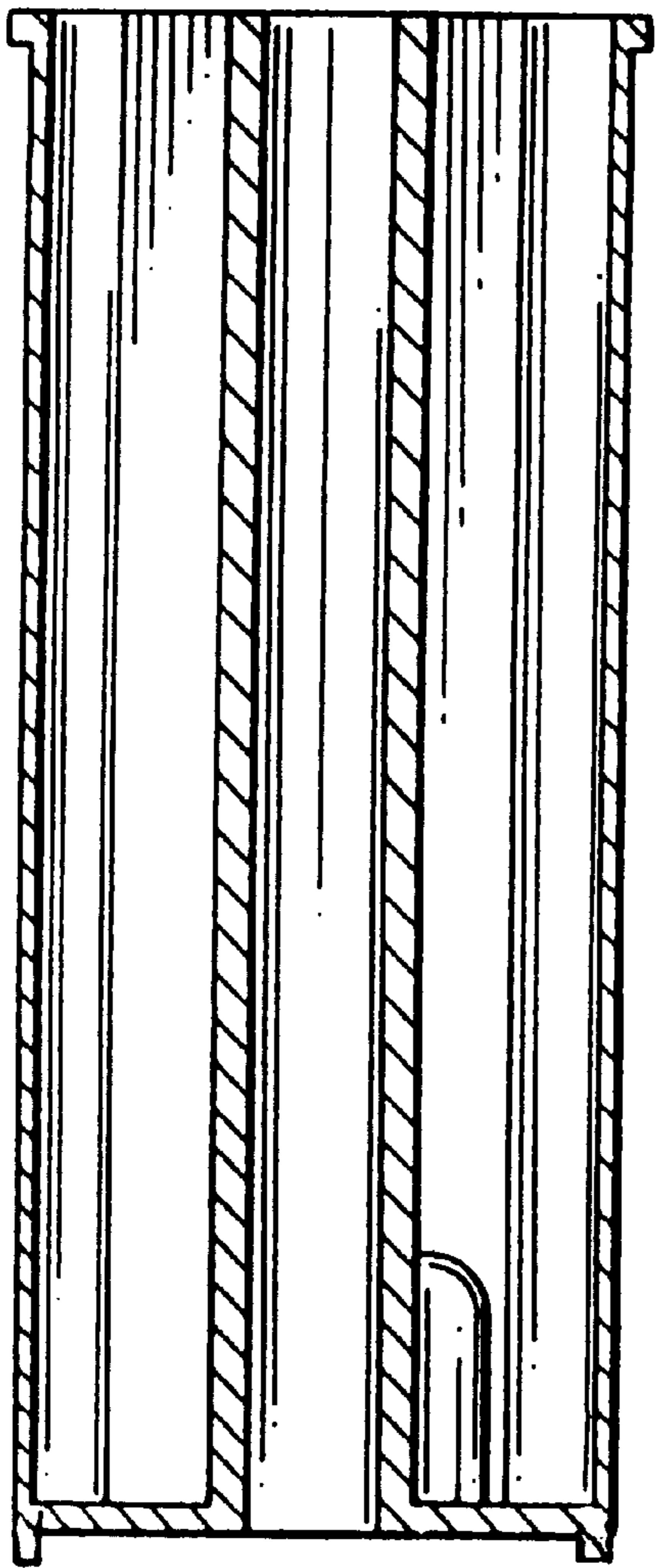

FIG. 5

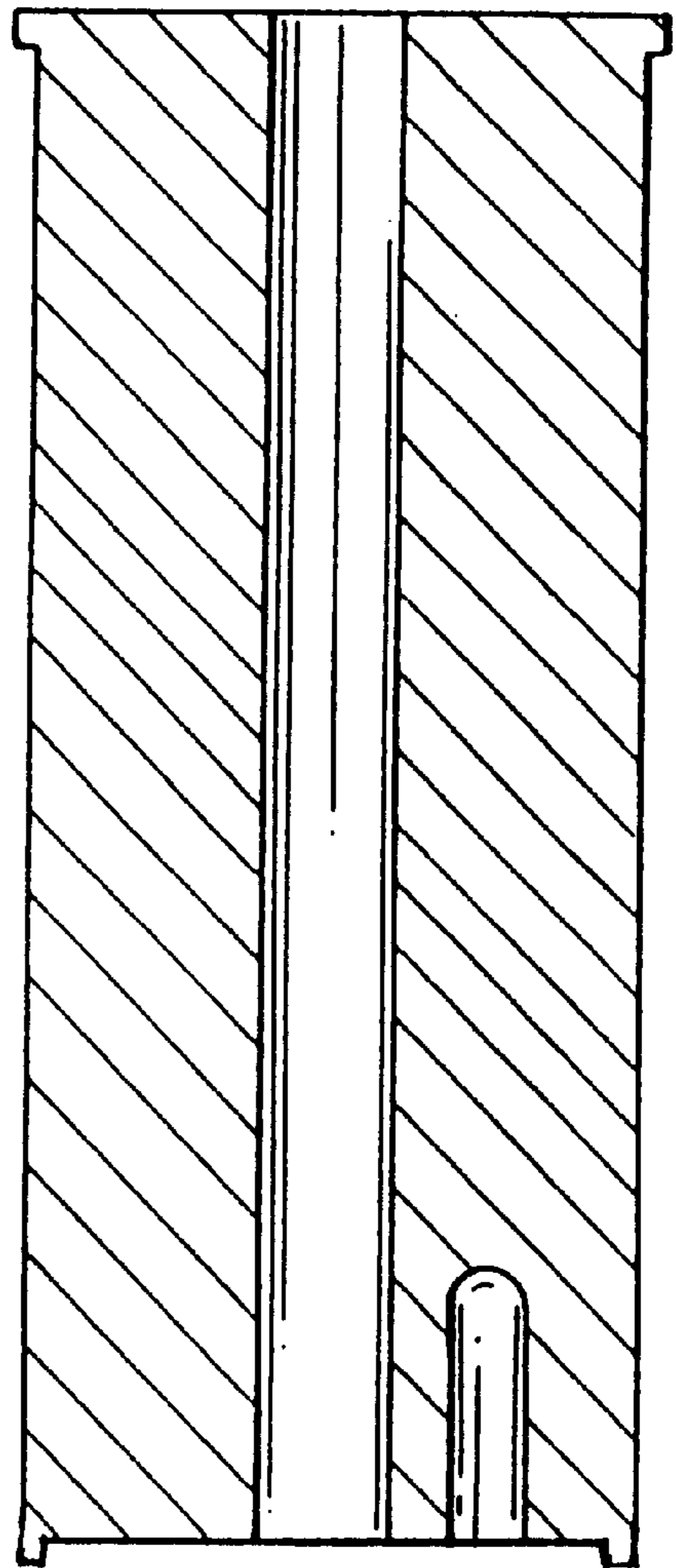

FIG. 6