



US00D425320S

# United States Patent [19]

Lindsay et al.

[11] Patent Number: **Des. 425,320**

[45] Date of Patent: **\*\* May 23, 2000**

[54] **COMBINED CHAIR AND STEPSTOOL**

[76] Inventors: **Jeffrey D. Lindsay; Marilyn Lindsay**,  
both of 18406 Friar St., Reseda, Calif.  
91335

[\*\*] Term: **14 Years**

[21] Appl. No.: **29/104,598**

[22] Filed: **May 6, 1999**

[51] **LOC (7) Cl.** ..... **06-01**

[52] **U.S. Cl.** ..... **D6/335**

[58] **Field of Search** ..... D6/334, 335, 336,  
D6/337, 338, 349, 350, 353, 374, 500-502;  
297/124, 126, 118

[56] **References Cited**

**U.S. PATENT DOCUMENTS**

D. 248,903	8/1978	O'Connor	.....	D6/337
D. 273,060	3/1984	Martin	.....	D6/338
D. 351,739	10/1994	Cannon	.....	D6/350
D. 368,171	3/1996	Snell	.....	D6/336
5,704,683	1/1998	Cooper et al.	.....	297/124

*Primary Examiner*—Jeffrey Asch  
*Assistant Examiner*—Mimosa De

[57] **CLAIM**

The ornamental design for a combined chair and stepstool,  
as shown and described.

**DESCRIPTION**

FIG. 1 is a front elevational view of the combined chair and stepstool of the present invention;  
FIG. 2 is a back elevational view of the combined chair and stepstool of FIG. 1;  
FIG. 3 is a left side elevational view of the combined chair and stepstool of FIG. 1;  
FIG. 4 is a right side elevational view of the combined chair and stepstool of FIG. 1;  
FIG. 5 is a top plan view of the combined chair and stepstool of FIG. 1; and  
FIG. 6 is a bottom plan view of the combined chair and stepstool of FIG. 1; and,  
FIG. 7 is a top, front, right side perspective view of the combined chair and stepstool of FIG. 1 in an alternate position.

**1 Claim, 4 Drawing Sheets**

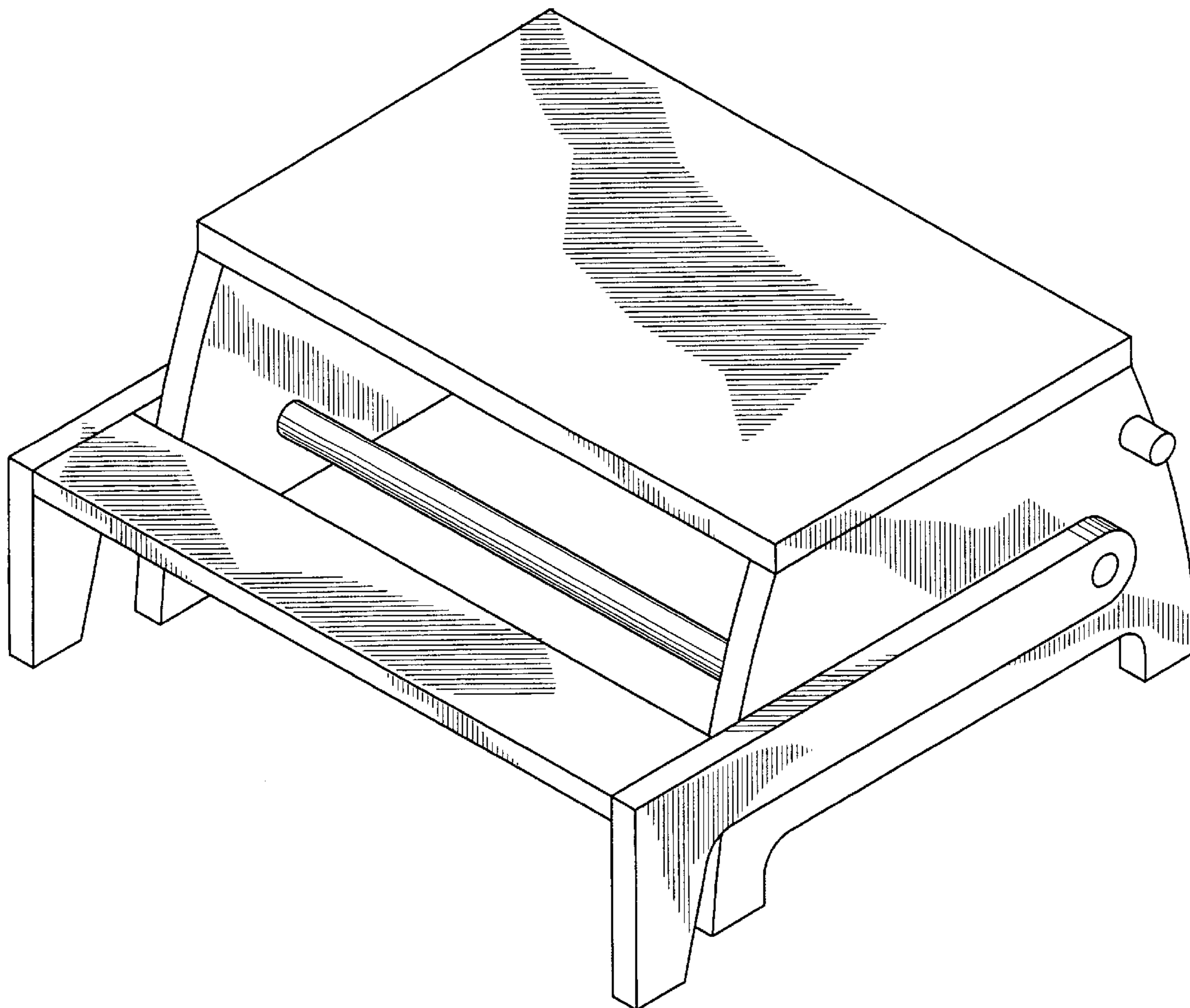

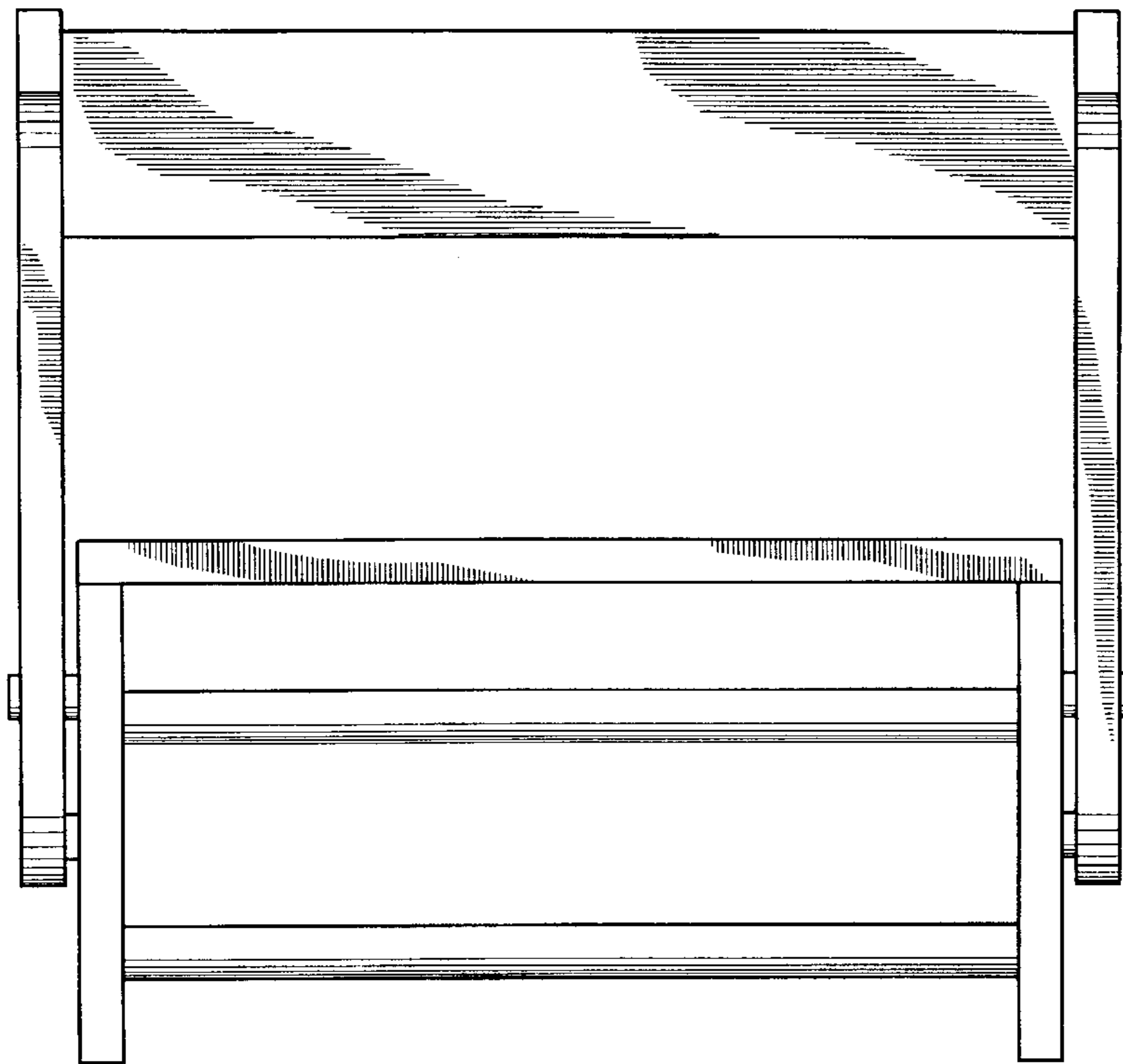
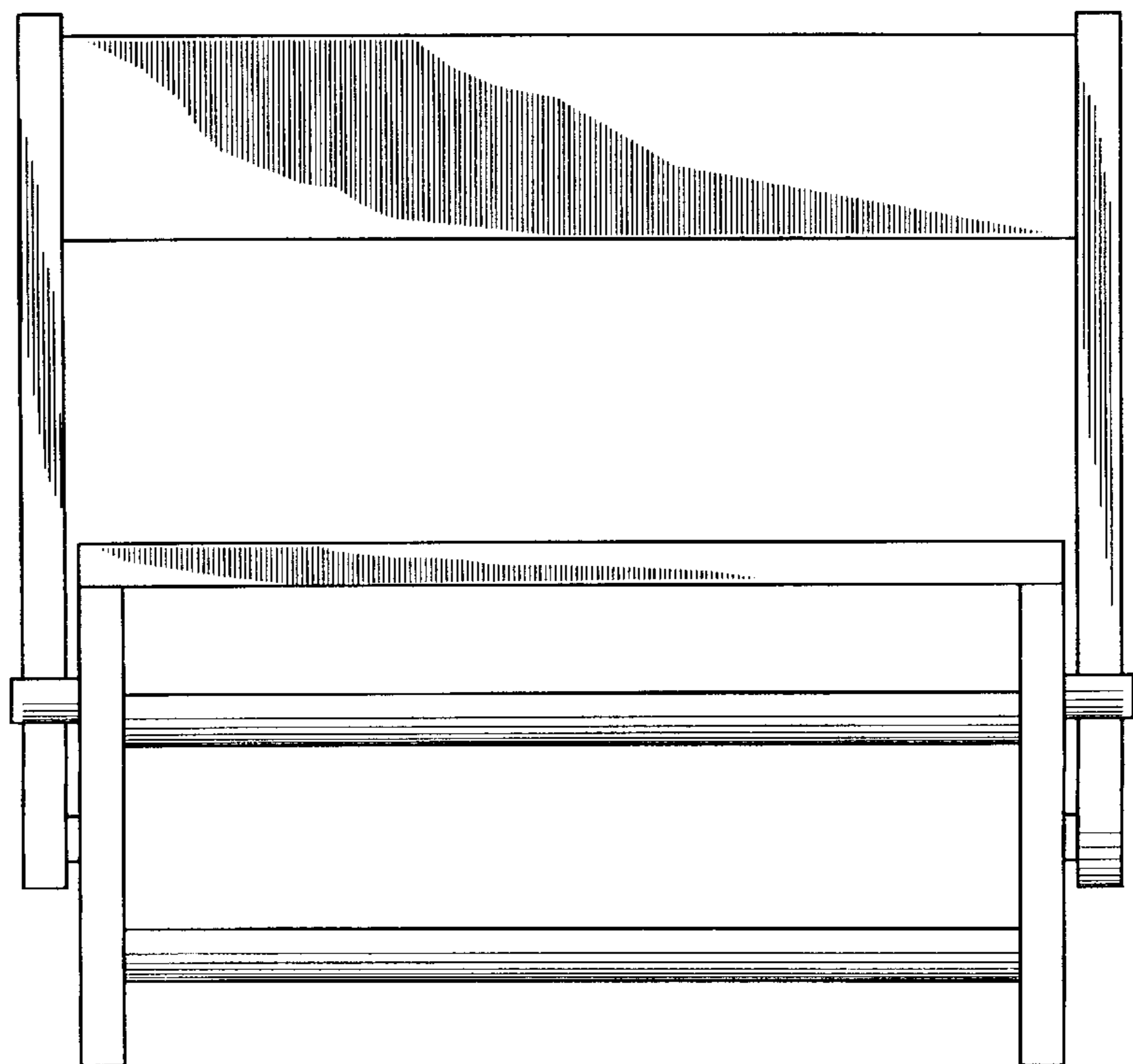

FIG. 1

FIG. 2



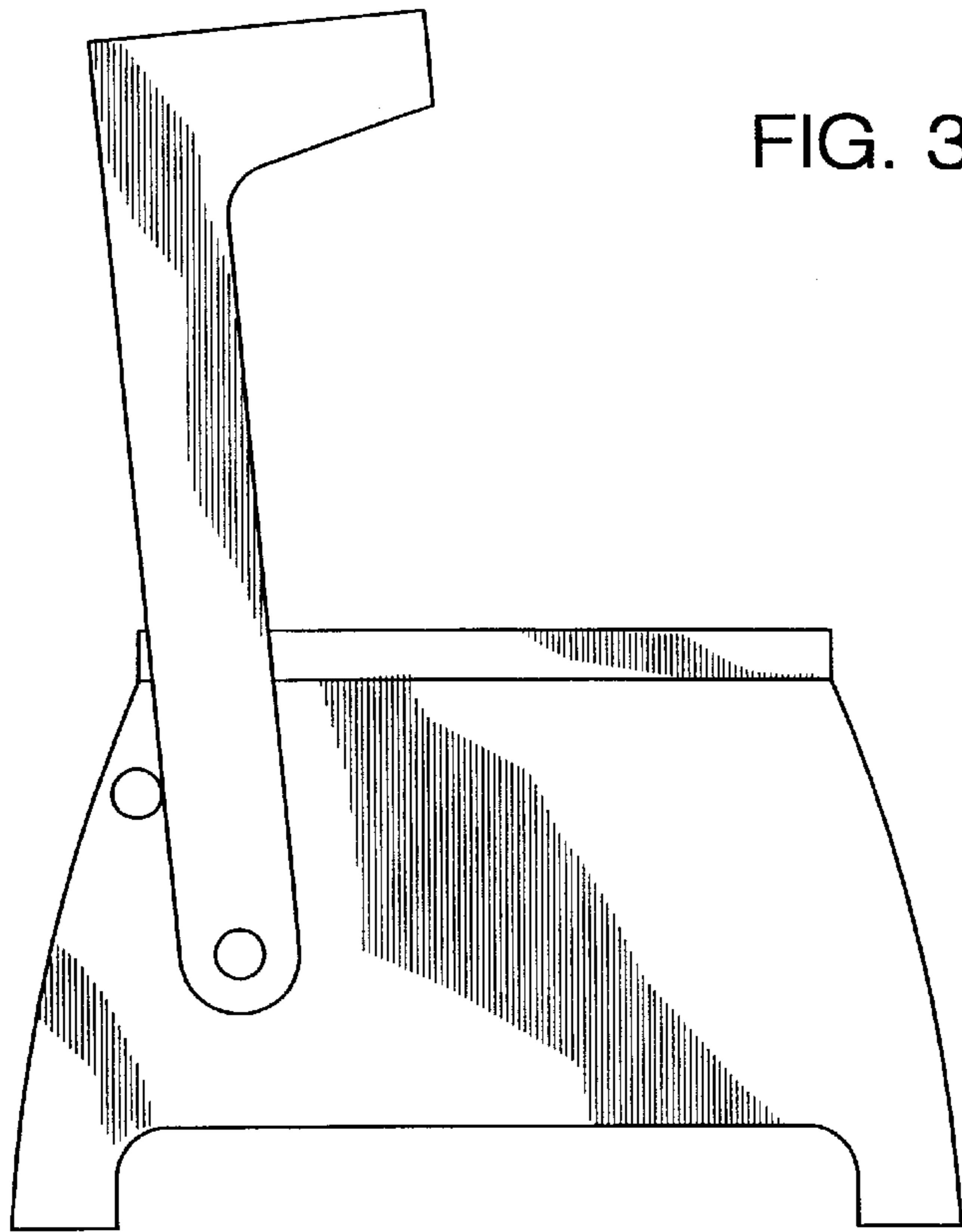

FIG. 3

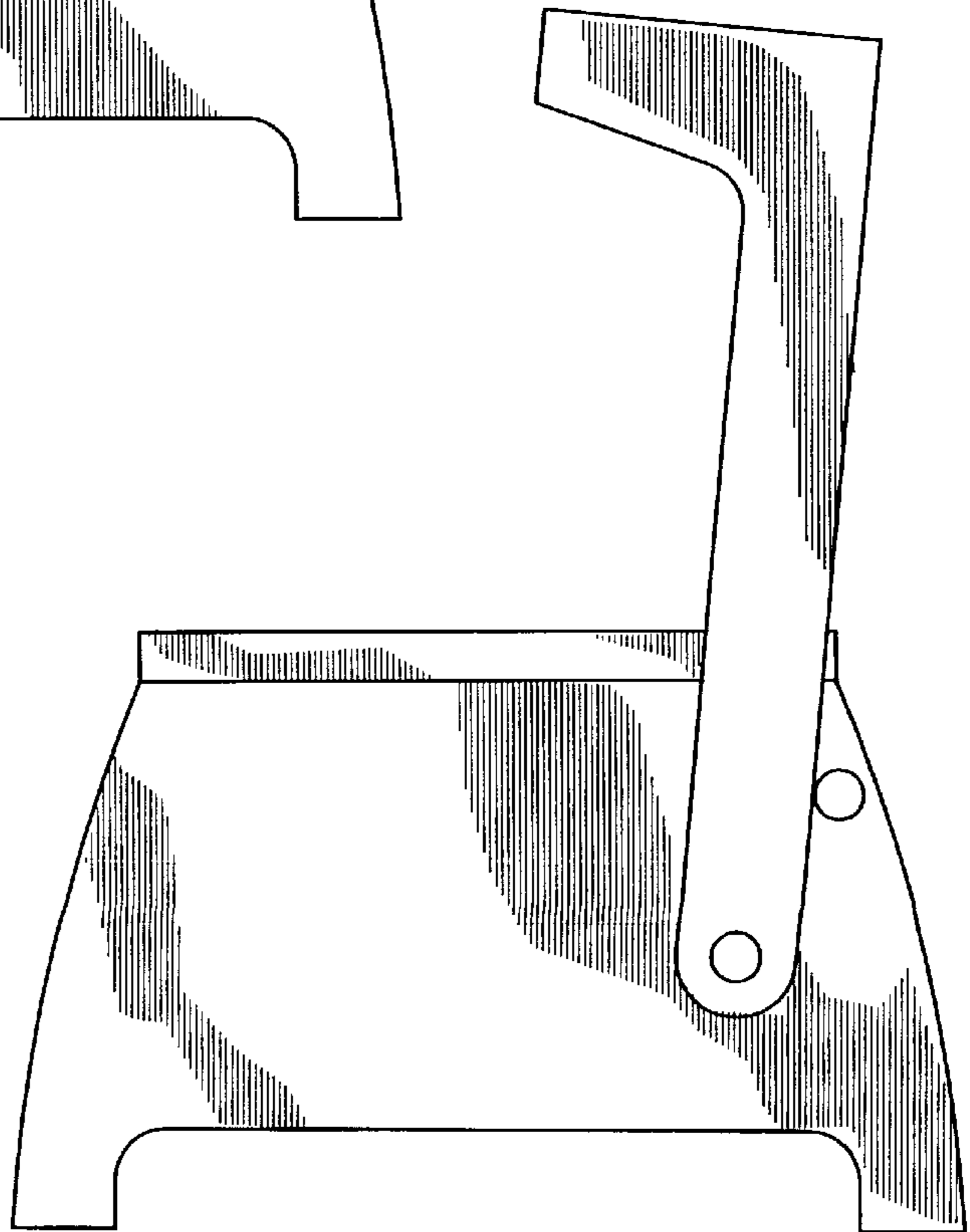

FIG. 4

FIG. 5

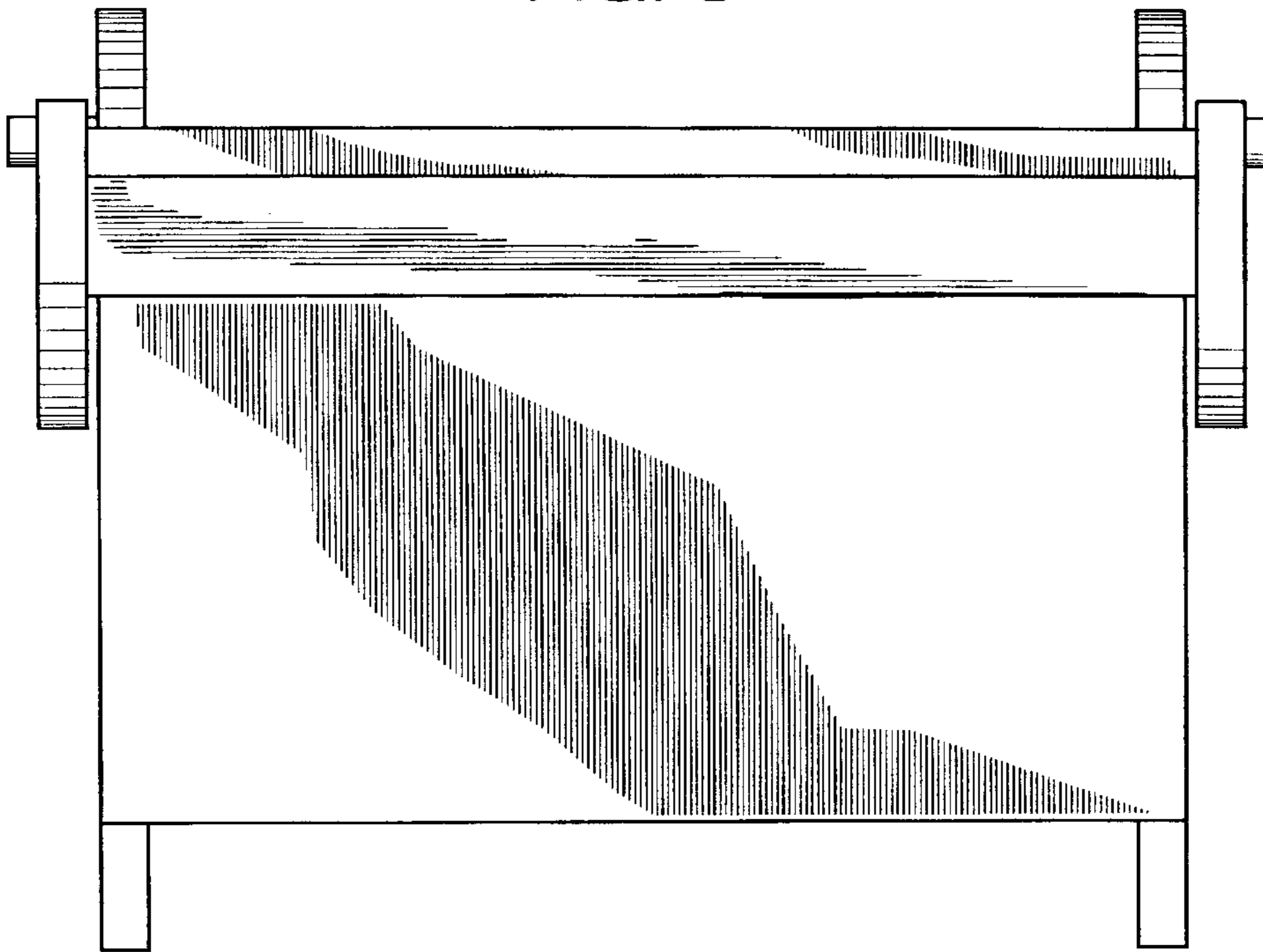

FIG. 6

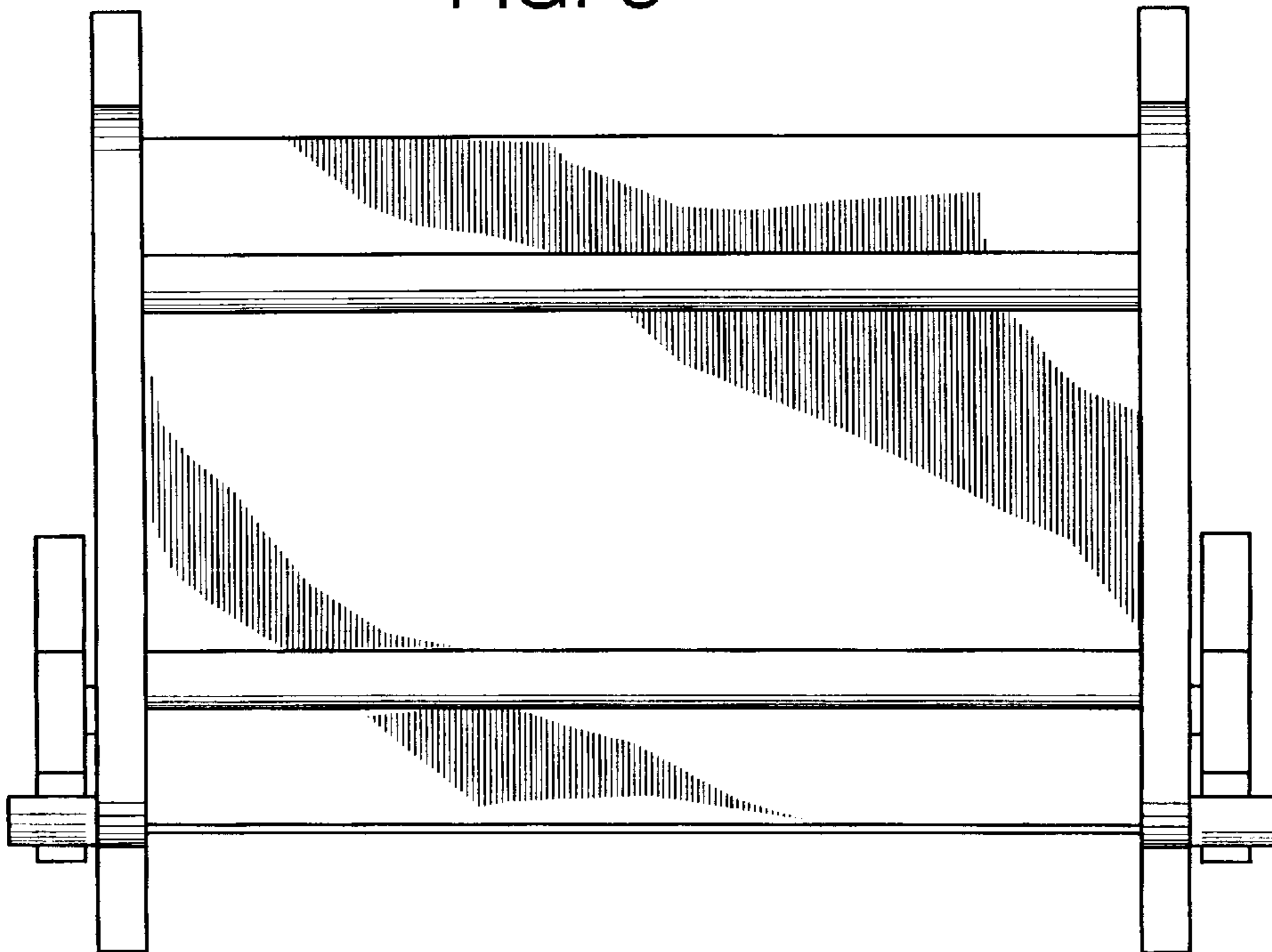

FIG. 7

