



US00D425140S

United States Patent [19] Bao

[11] **Patent Number: Des. 425,140**

[45] **Date of Patent: ** May 16, 2000**

[54] **TOY TANK**

[75] Inventor: **Wei Gang Bao**, Hefei, China

[73] Assignee: **Golden Bright Manufacturer Ltd.**,
Kowloon, The Hong Kong Special
Administrative Region of the People's
Republic of China

[**] Term: **14 Years**

[21] Appl. No.: **29/100,902**

[22] Filed: **Feb. 22, 1999**

[30] **Foreign Application Priority Data**

Jan. 6, 1999 [HK] The Hong Kong Special Administra-
tive Region of the People's Republic
of China 9910008.7M001

[51] **LOC (7) Cl.** **21-01**

[52] **U.S. Cl.** **D21/539**

[58] **Field of Search** D21/539, 427,
D21/419; D12/1, 12; 446/433, 429, 430,
465, 470, 435

[56] **References Cited**

U.S. PATENT DOCUMENTS

D. 169,229 3/1953 Tober D12/12

D. 258,223 2/1981 Itakura D21/539
3,065,569 11/1962 Nielsen et al. D12/12
3,869,825 3/1975 Heberlein 446/433
4,458,444 7/1984 Dudley 446/433

OTHER PUBLICATIONS

Popular Science, P96, Sep. 1976.

Road and Space, P13, 1995.

Primary Examiner—Raphael Barkai
Attorney, Agent, or Firm—Merchant & Gould P.C.

[57] **CLAIM**

The ornamental design for toy tank, as shown and described.

DESCRIPTION

FIG. 1 is a front elevational view of an embodiment of a toy tank showing my new design;

FIG. 2 is a rear elevational view thereof;

FIG. 3 is a top elevational view thereof;

FIG. 4 is a bottom elevational view thereof;

FIG. 5 is a left side elevational view thereof; and,

FIG. 6 is a right side elevational view thereof.

1 Claim, 6 Drawing Sheets

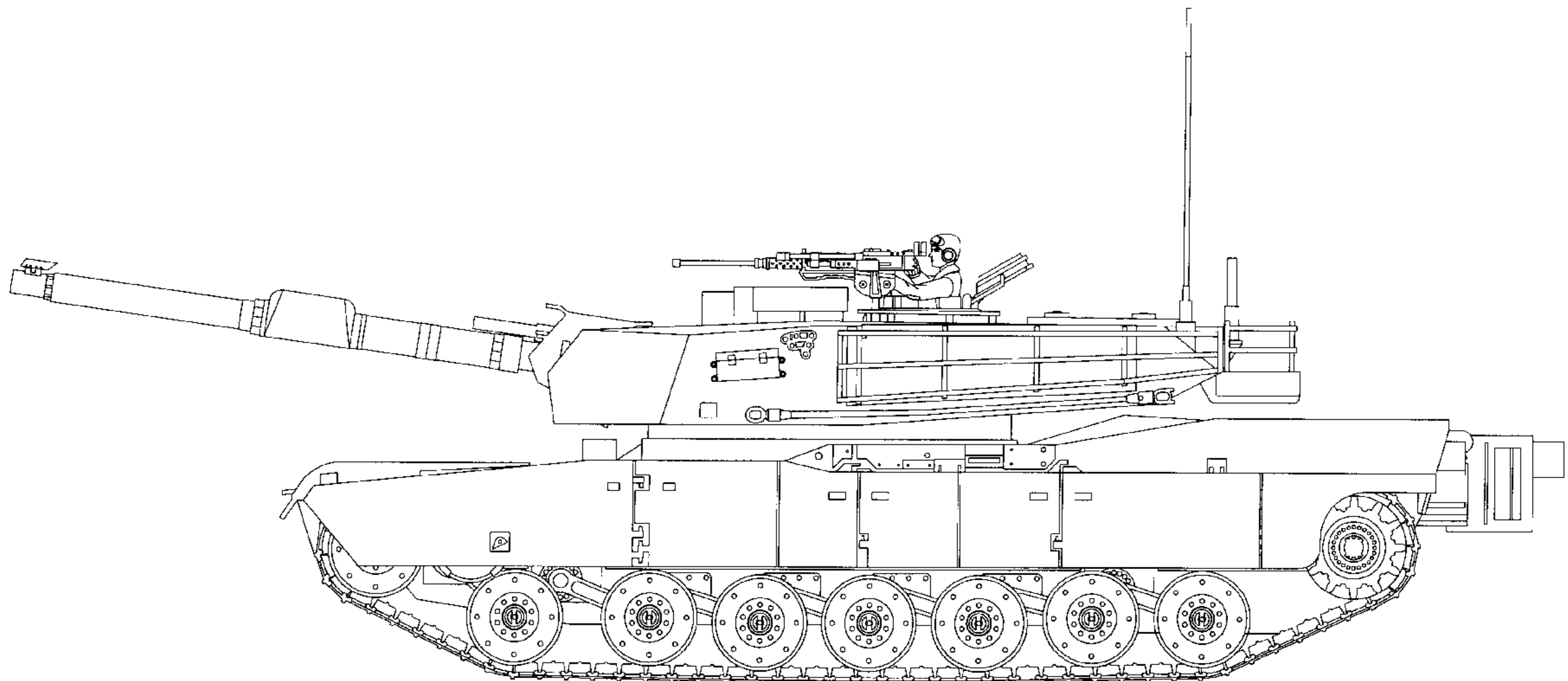

FIG. 1

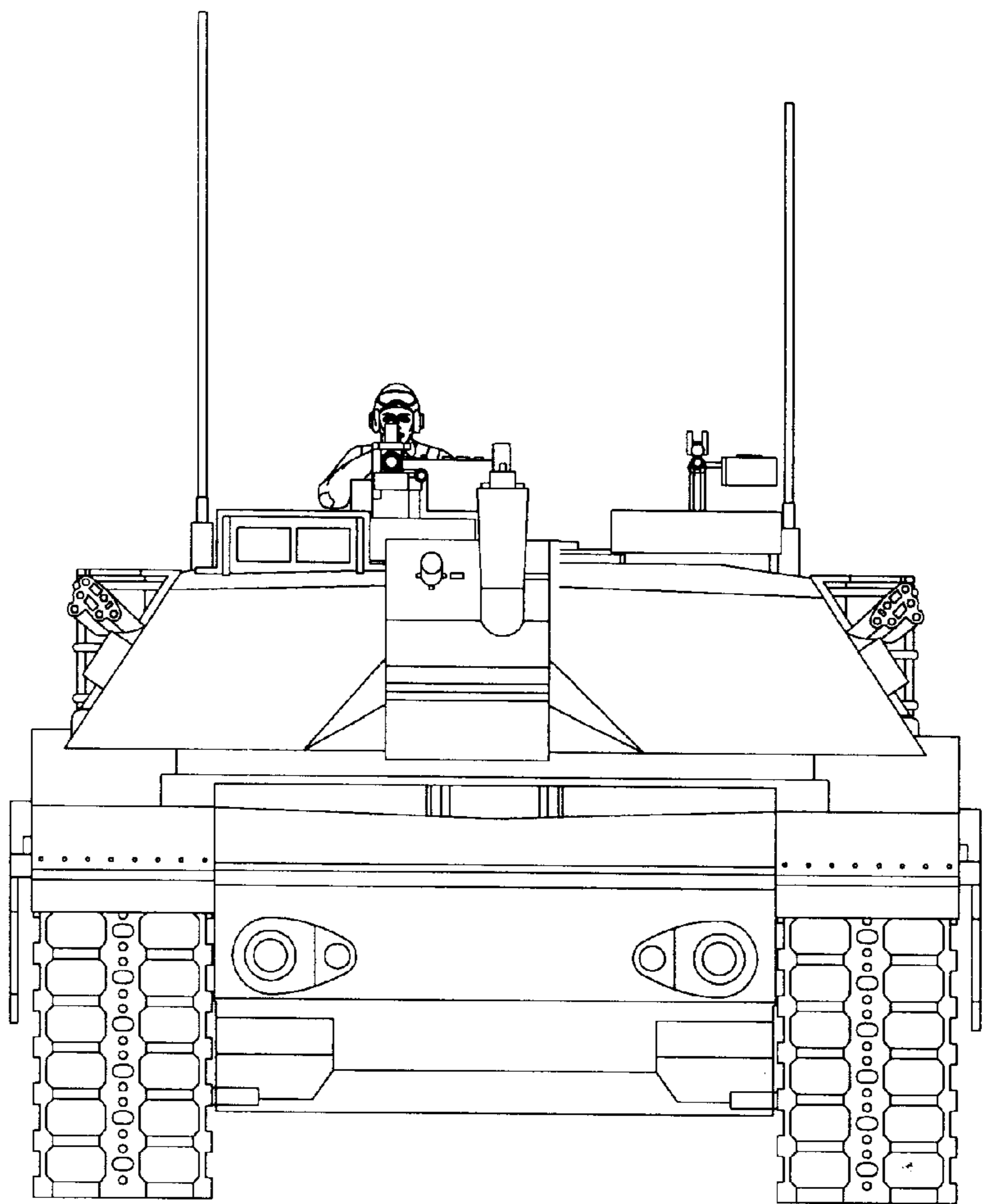

FIG. 2

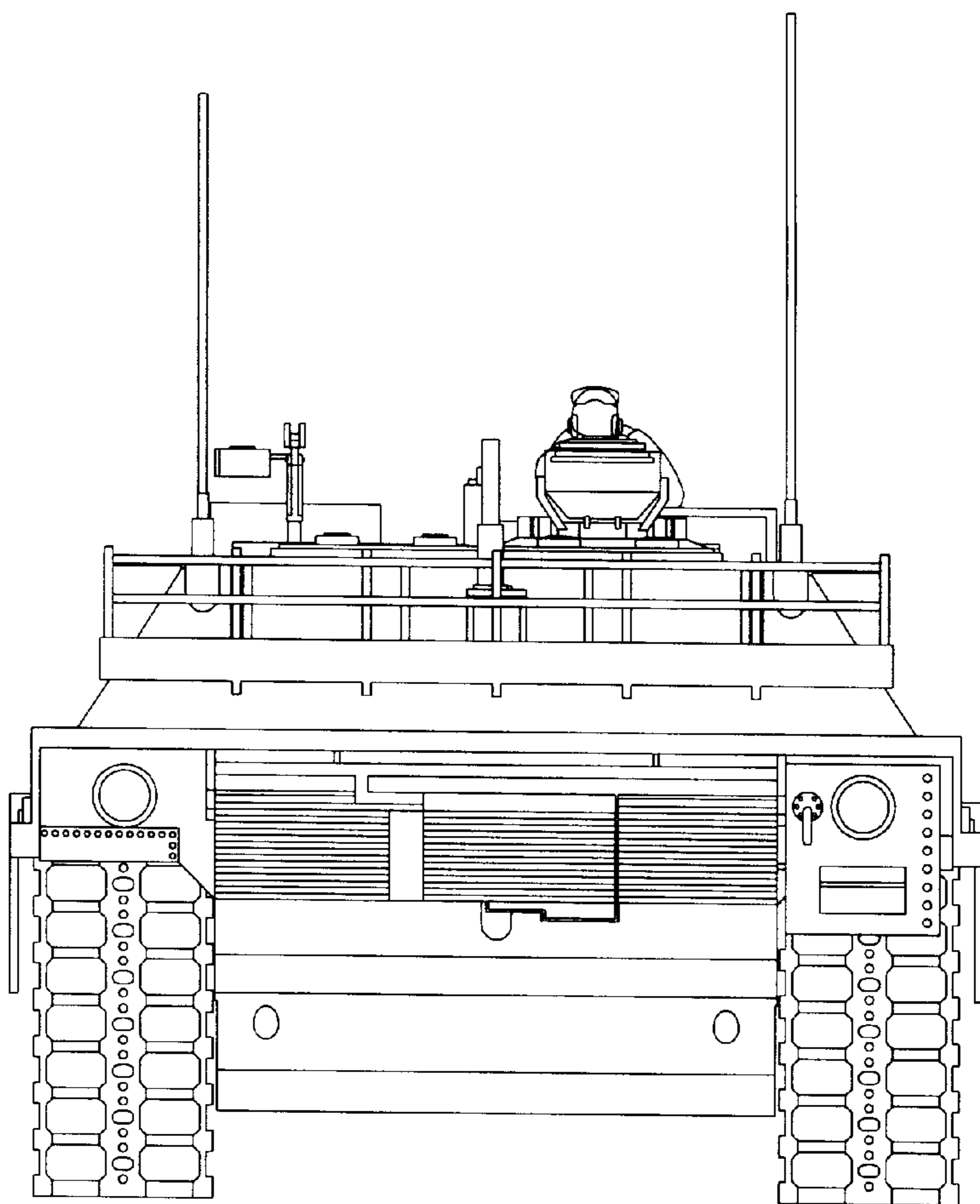

FIG. 3

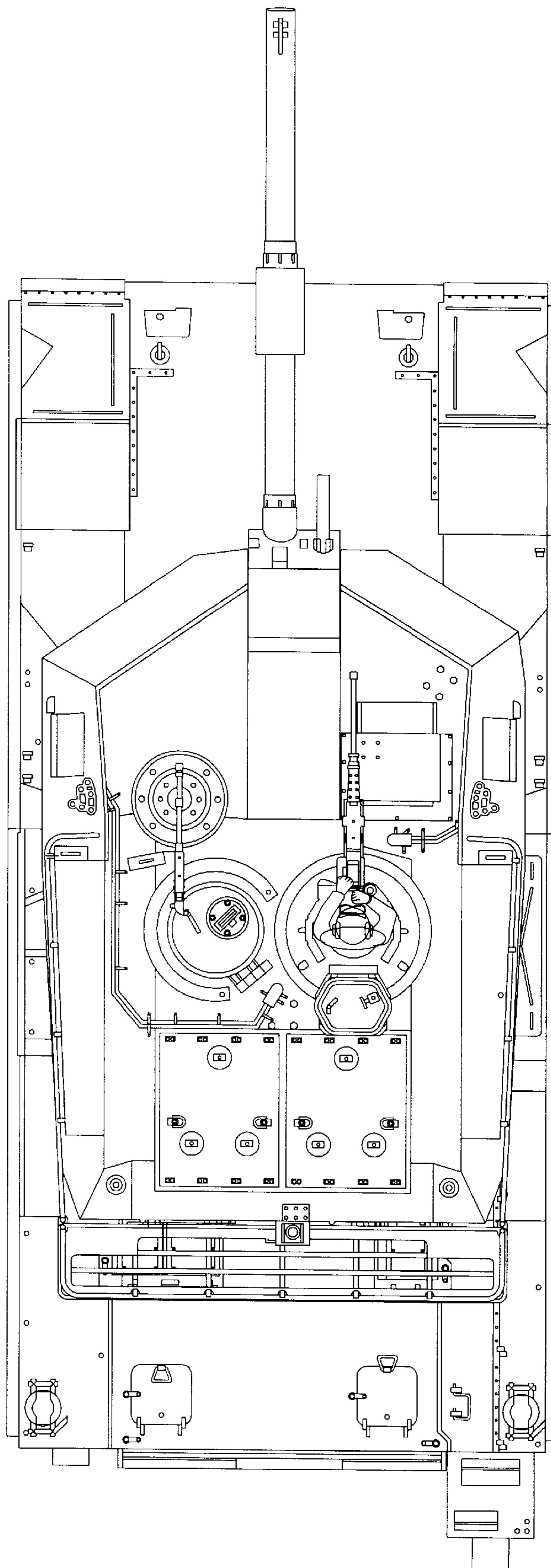
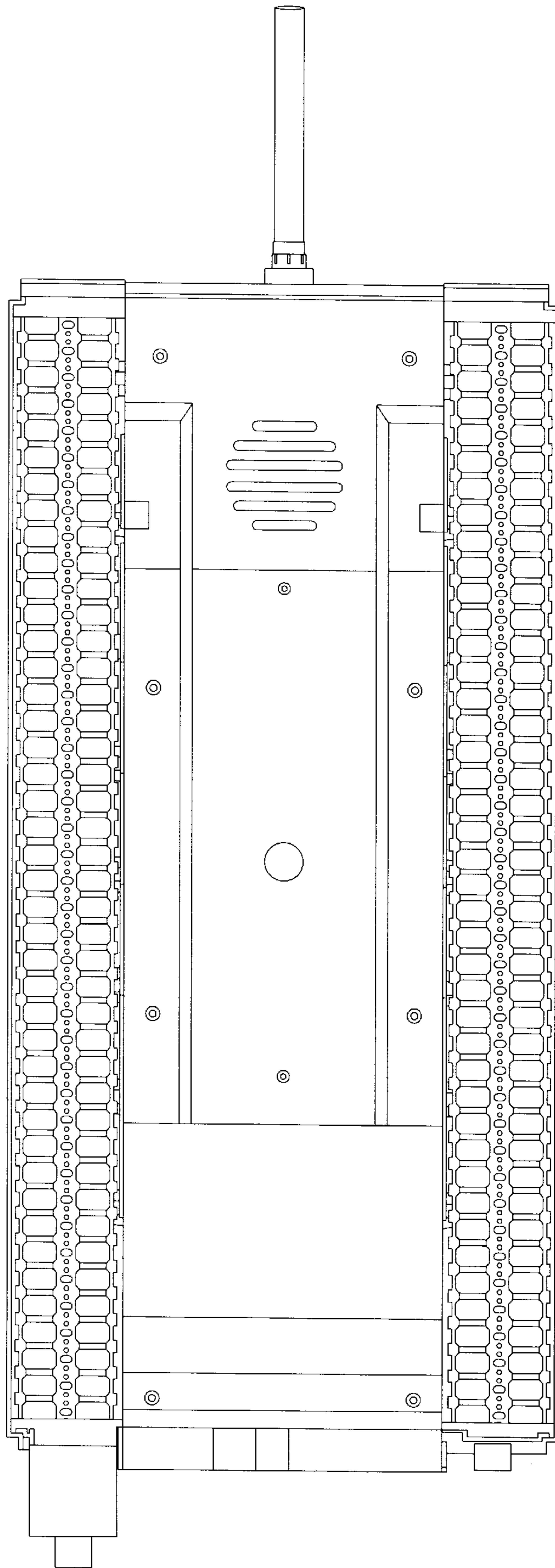

FIG. 4



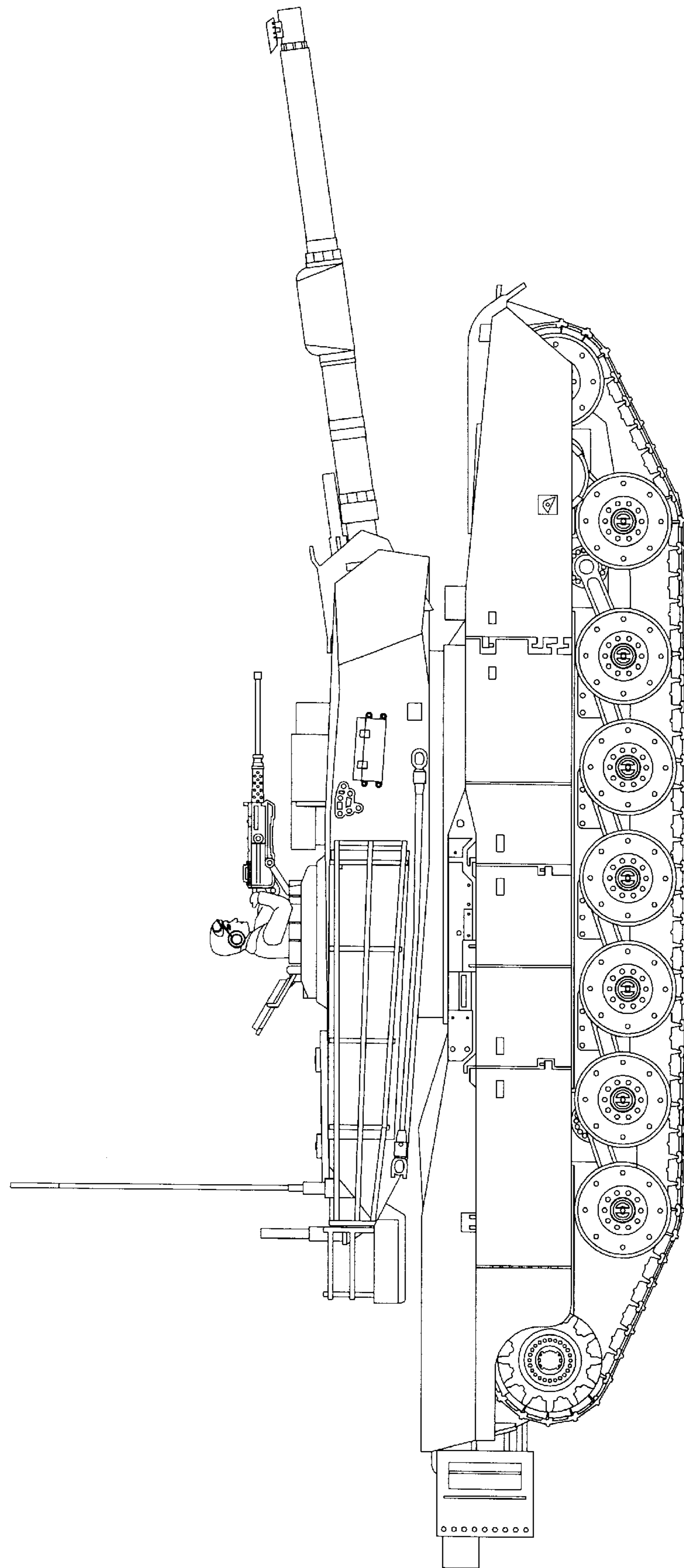

FIG. 5

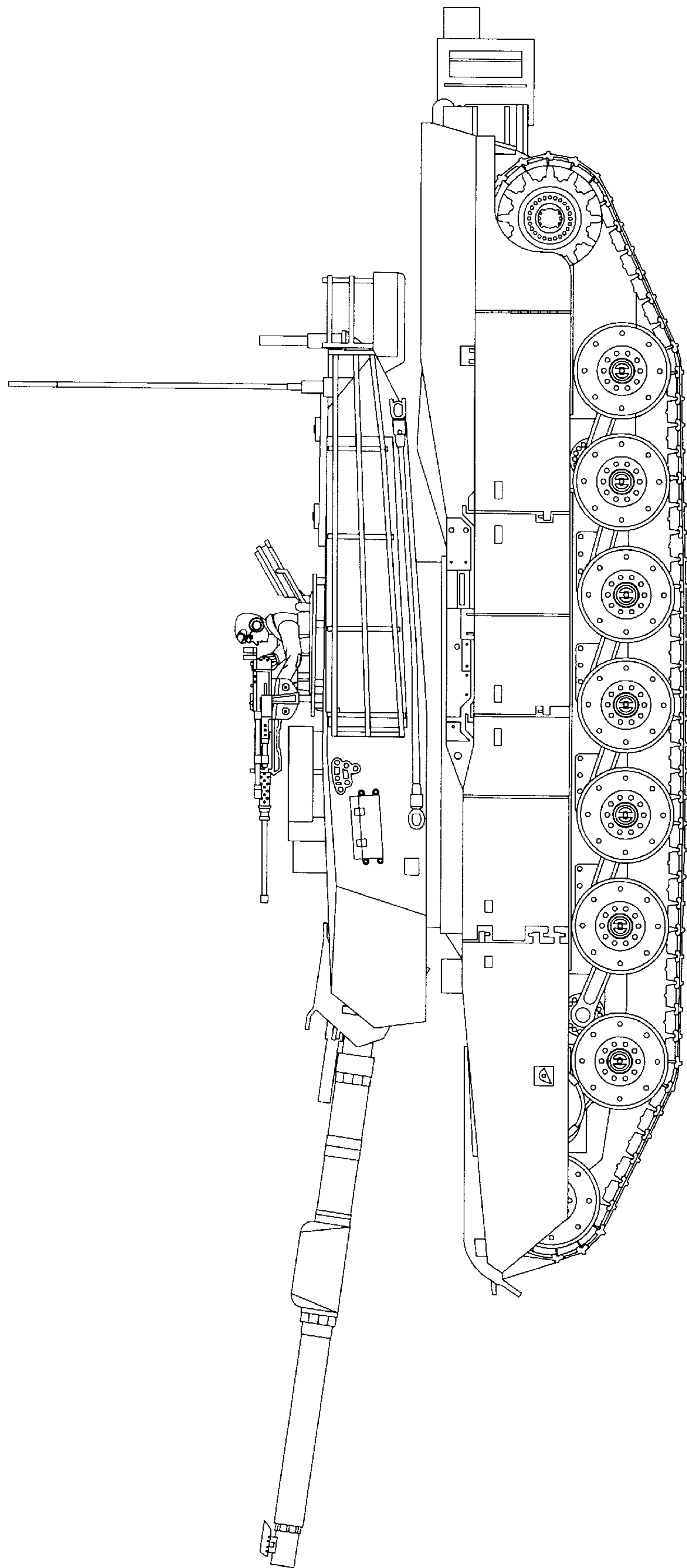

FIG. 6