



US00D425112S

# United States Patent [19]

[11] **Patent Number: Des. 425,112**

**Shinada et al.**

[45] **Date of Patent: \*\* May 16, 2000**

[54] **INK CARTRIDGE FOR PRINTER**

[75] Inventors: **Satoshi Shinada; Takeo Seino**, both of Suwa, Japan

[73] Assignee: **Seiko Epson Corporation**, Tokyo, Japan

[\*\*] Term: **14 Years**

[21] Appl. No.: **29/105,294**

[22] Filed: **May 21, 1999**

[30] **Foreign Application Priority Data**

Nov. 25, 1998 [JP] Japan ..... 10-33855

[51] **LOC (7) Cl.** ..... **18-02**

[52] **U.S. Cl.** ..... **D18/56; 347/86**

[58] **Field of Search** ..... **D18/56; 347/86, 347/87**

[56] **References Cited**

**U.S. PATENT DOCUMENTS**

D. 378,760	4/1997	Shinada et al. ....	D18/56
D. 382,296	8/1997	Shinada et al. ....	D18/56
D. 387,801	12/1997	Miyazawa et al. .	
D. 390,261	2/1998	Miyazawa et al. ....	D18/56
D. 397,143	8/1998	Kobayashi et al. ....	D18/56
D. 400,575	11/1998	Kobayashi et al. ....	D18/56
5,606,354	2/1997	Bekki et al. ....	347/33

*Primary Examiner*—Cathy Anne MacCormac  
*Attorney, Agent, or Firm*—Stroock & Stroock & Lavan LLP

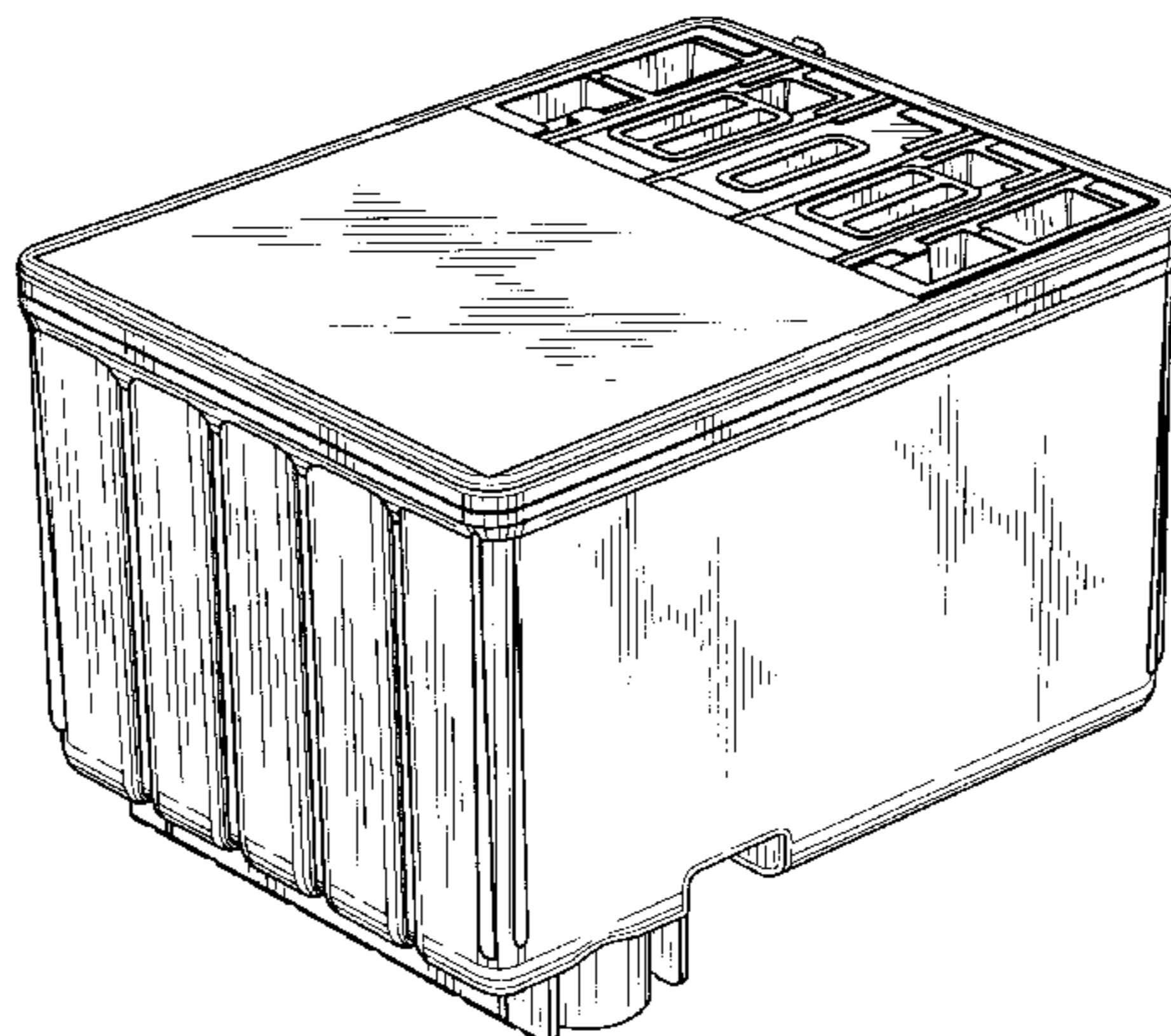
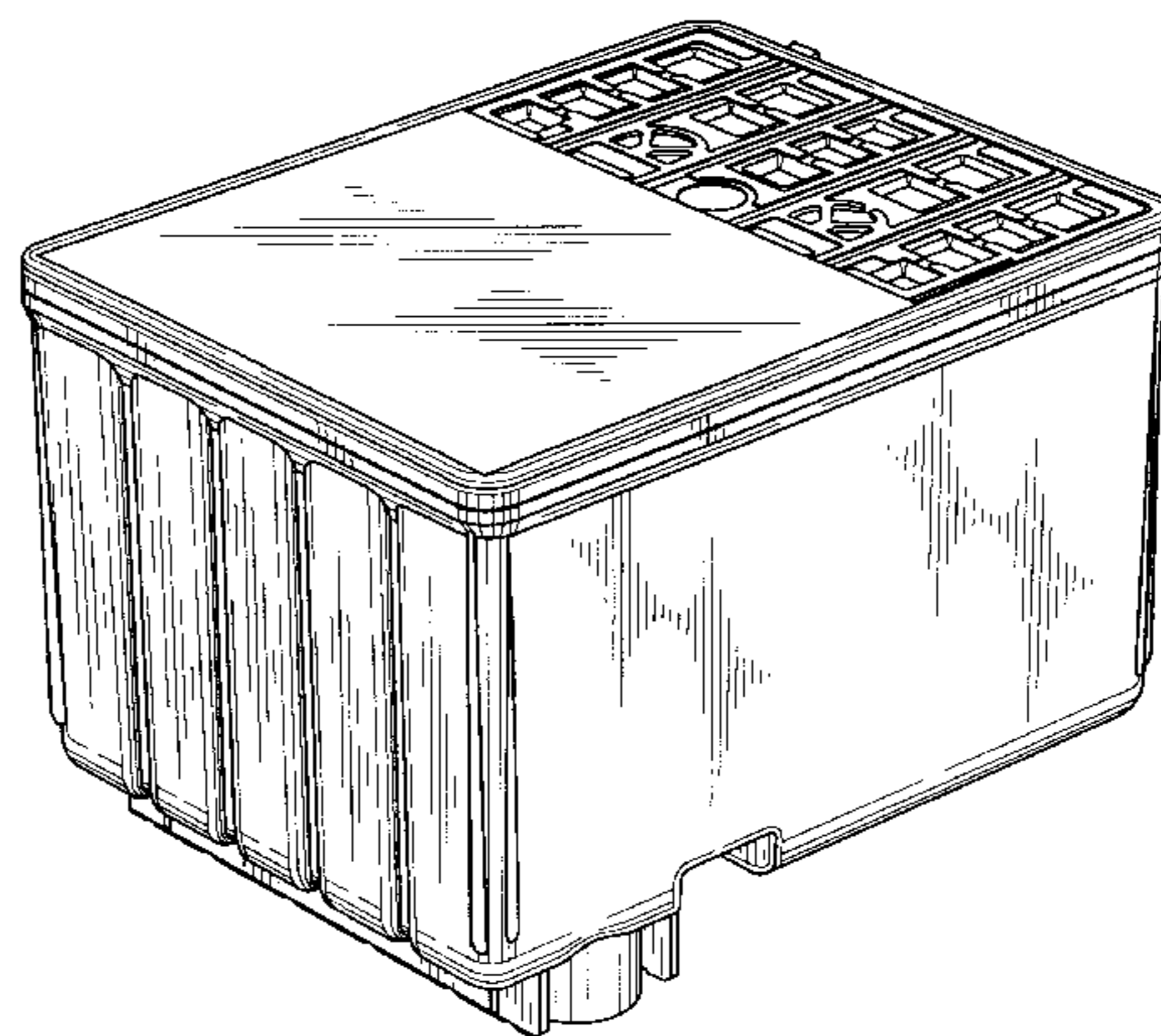
[57] **CLAIM**

The ornamental design for an ink cartridge for printer, as shown.

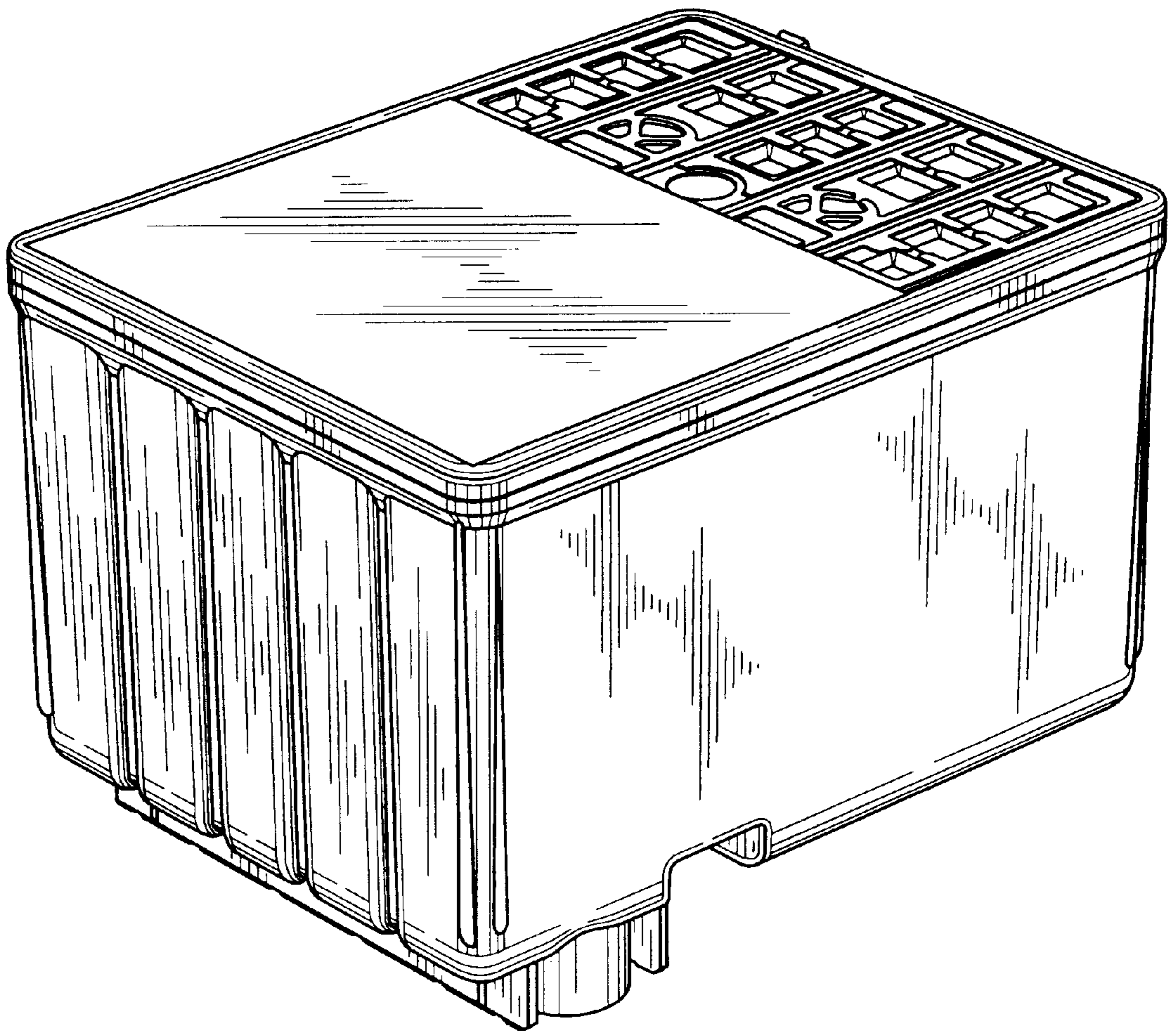
**DESCRIPTION**

FIG. 1 is a perspective view of the top, front and right side of an ink cartridge for printer showing our new design; FIG. 2 is a front elevational view thereof; FIG. 3 is a rear elevational view thereof; FIG. 4 is a top plan view thereof; FIG. 5 is a right side elevational view thereof; FIG. 6 is a left side elevation view thereof; FIG. 7 is a bottom view thereof; FIG. 8 is a perspective view of the top, front and right side of a second embodiment of FIG. 1; FIG. 9 is a front view of the second embodiment of FIG. 8; FIG. 10 is a rear view of the second embodiment of FIG. 8; FIG. 11 is a top plan view of the second embodiment of FIG. 8; FIG. 12 is a right side view of the second embodiment of FIG. 8; FIG. 13 is a left side view of the second embodiment of FIG. 8; and, FIG. 14 is a bottom view of the second embodiment of FIG. 8.

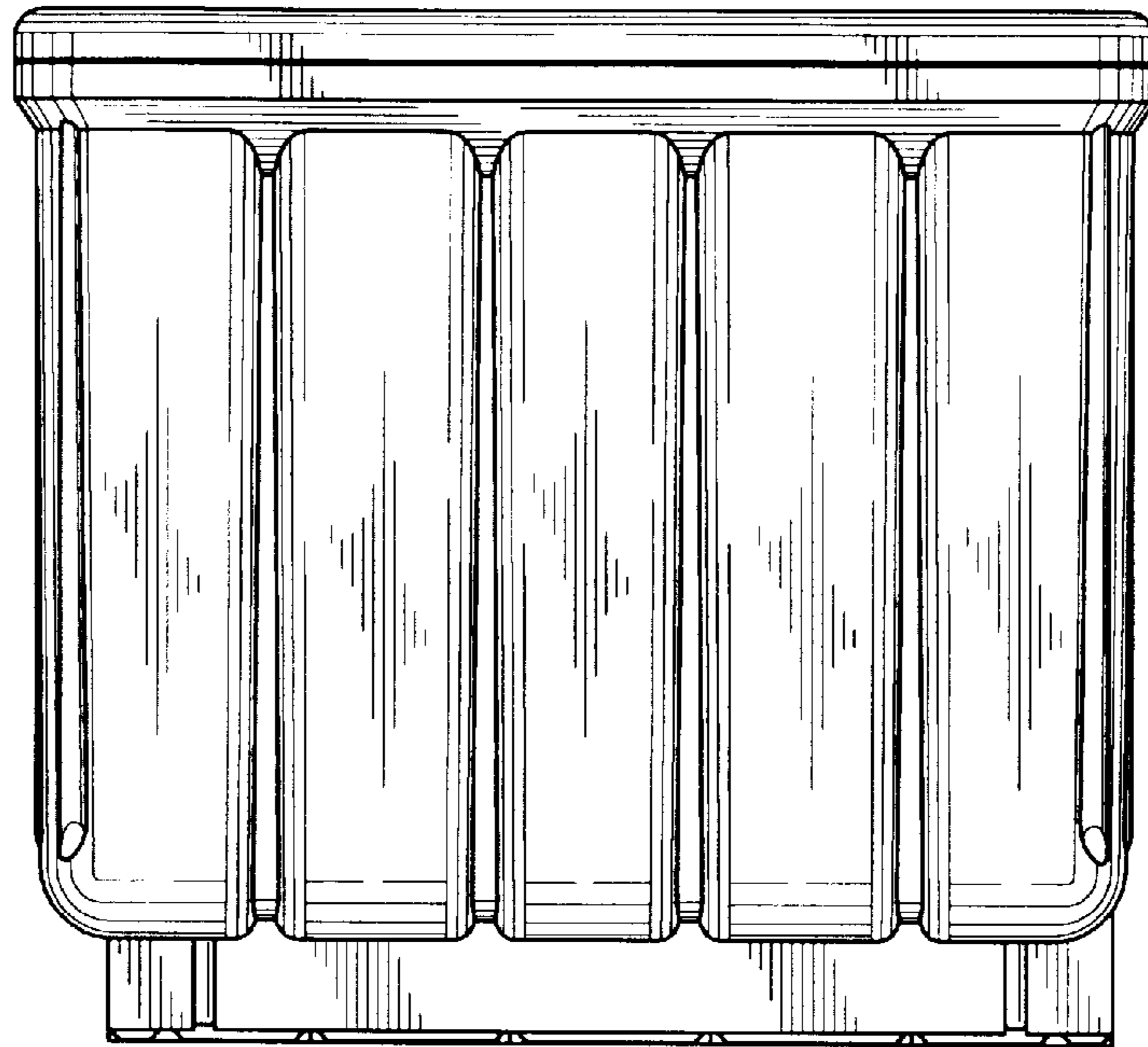
**1 Claim, 8 Drawing Sheets**



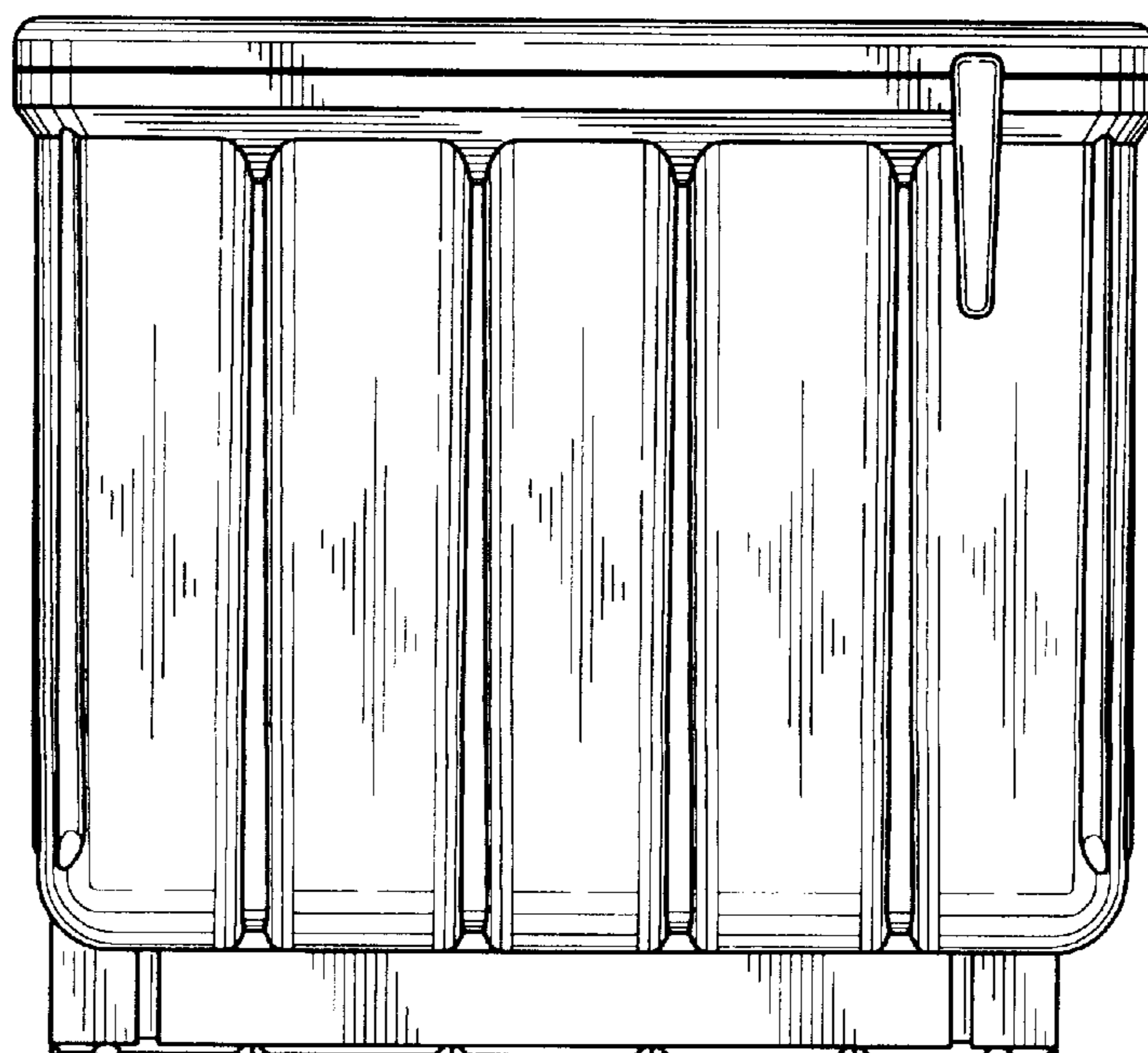
*FIG. 1*



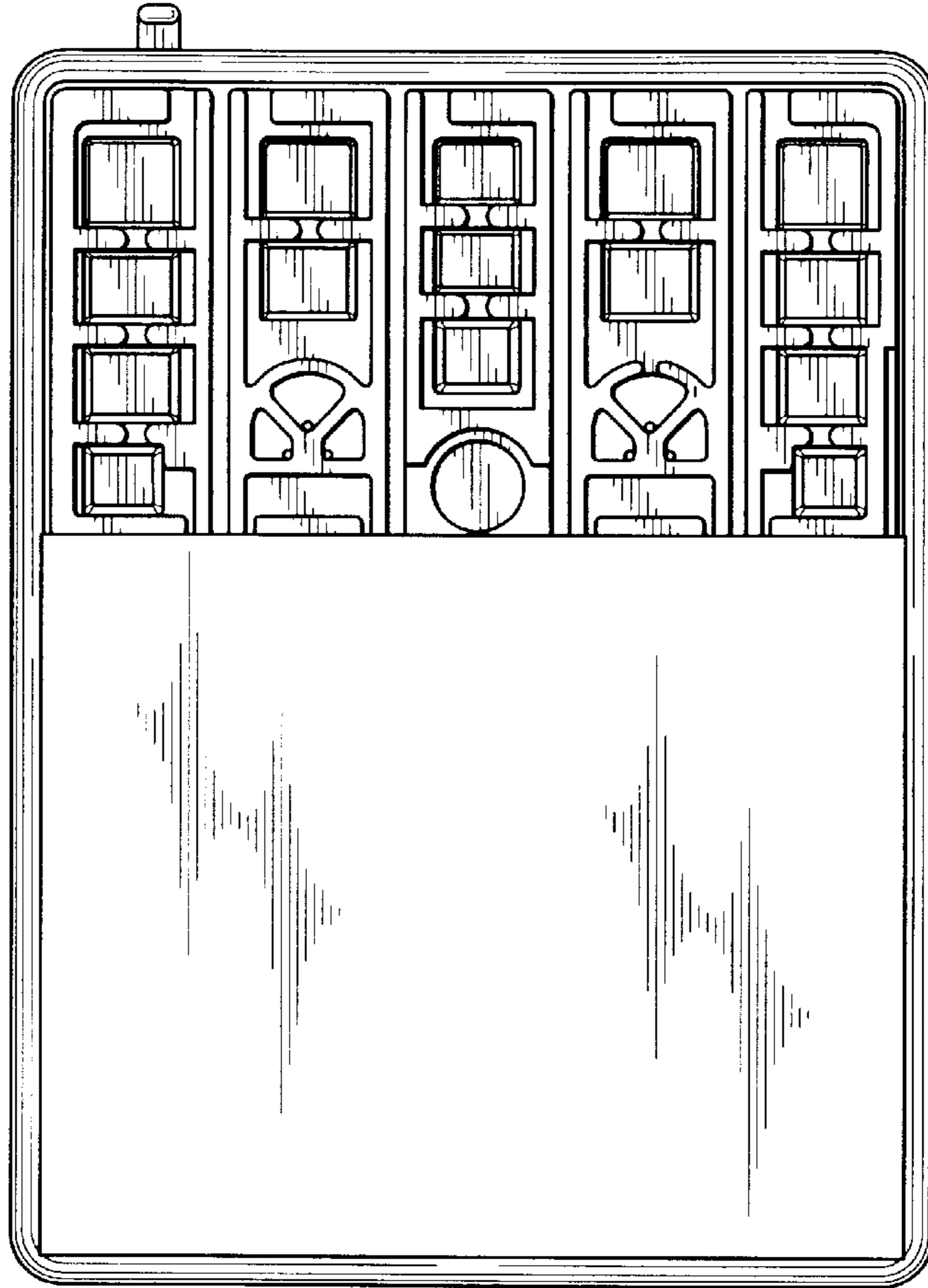
*FIG. 2*



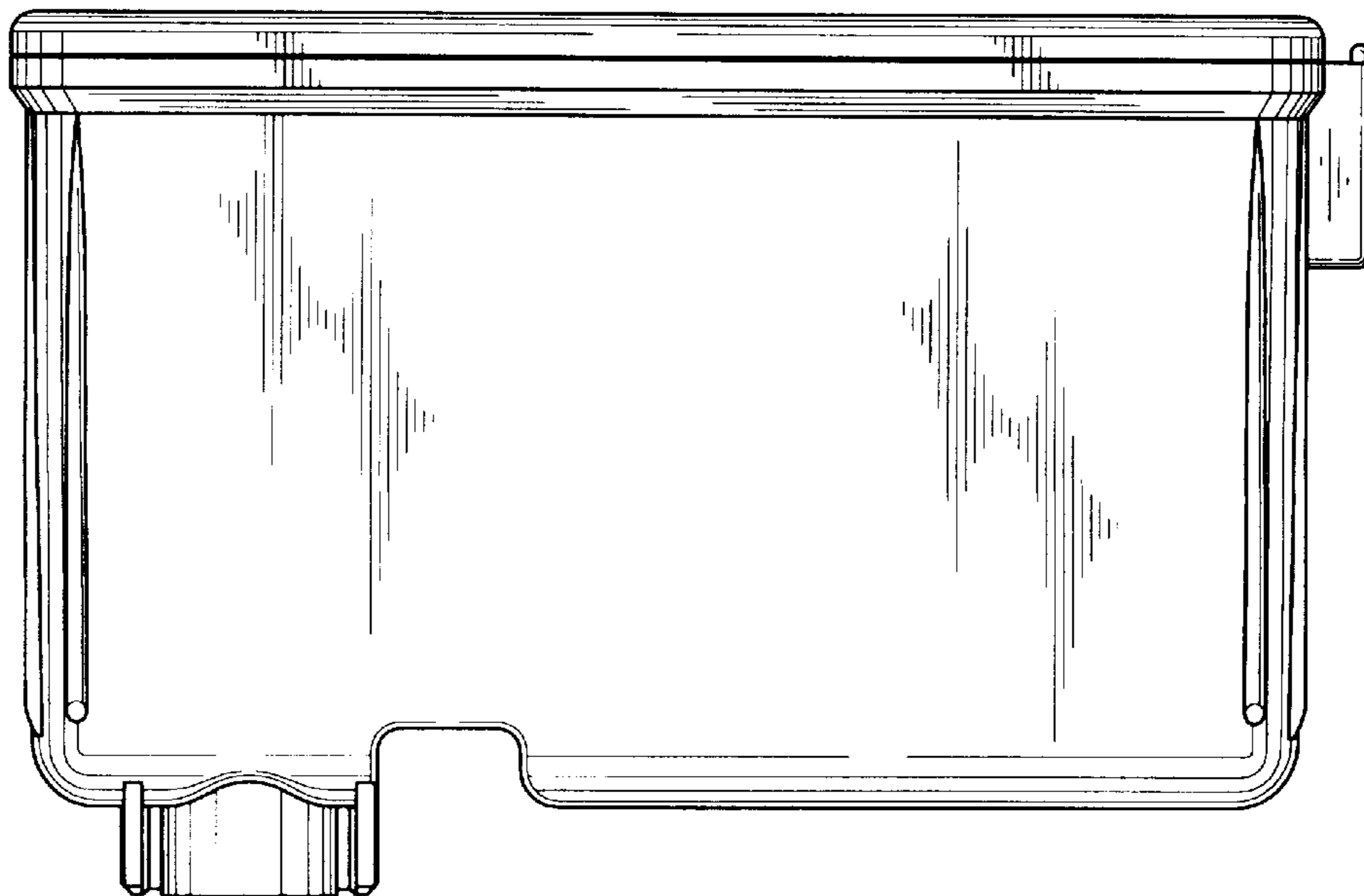
*FIG. 3*



**FIG. 4**

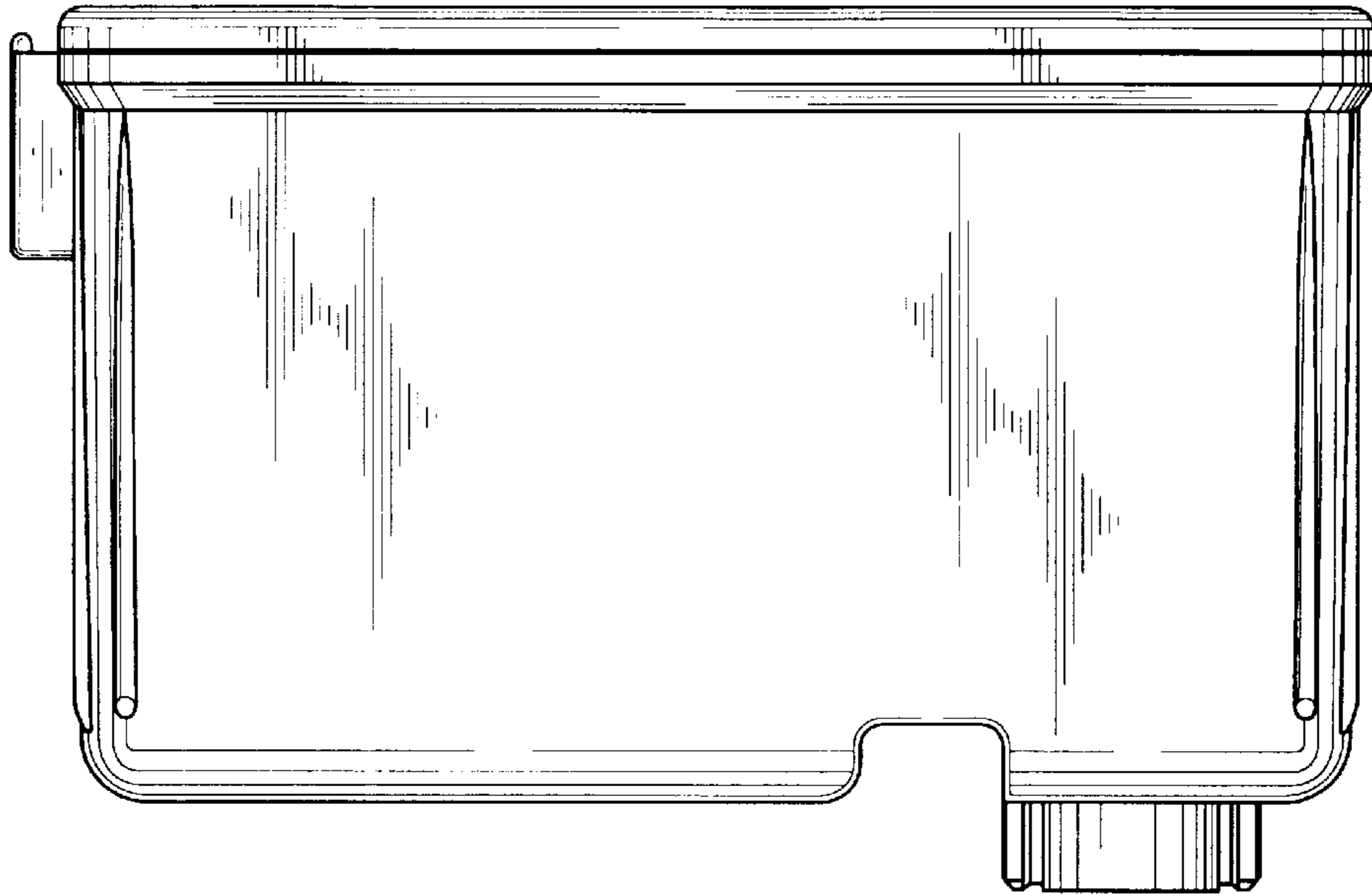


**FIG. 5**

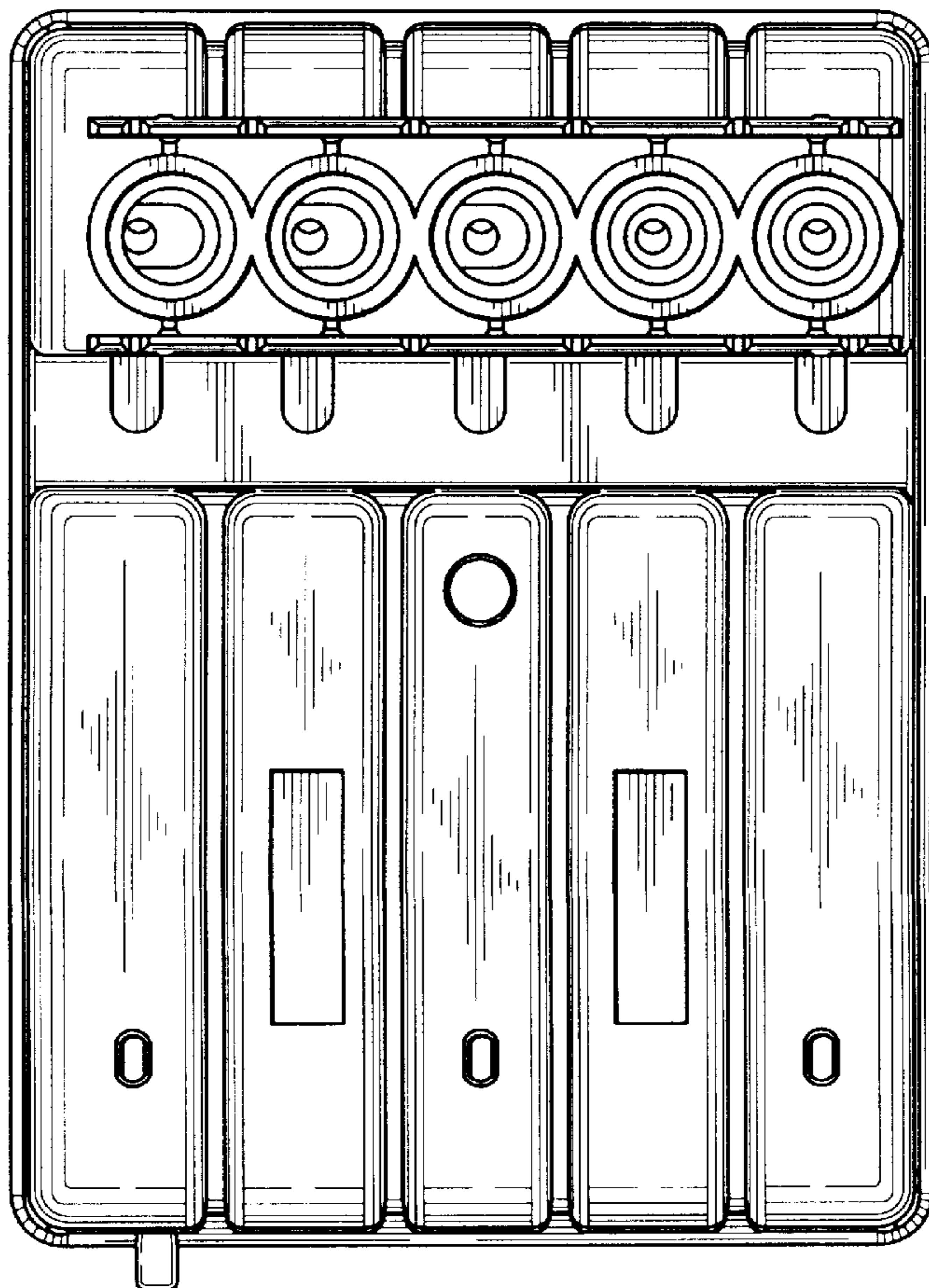




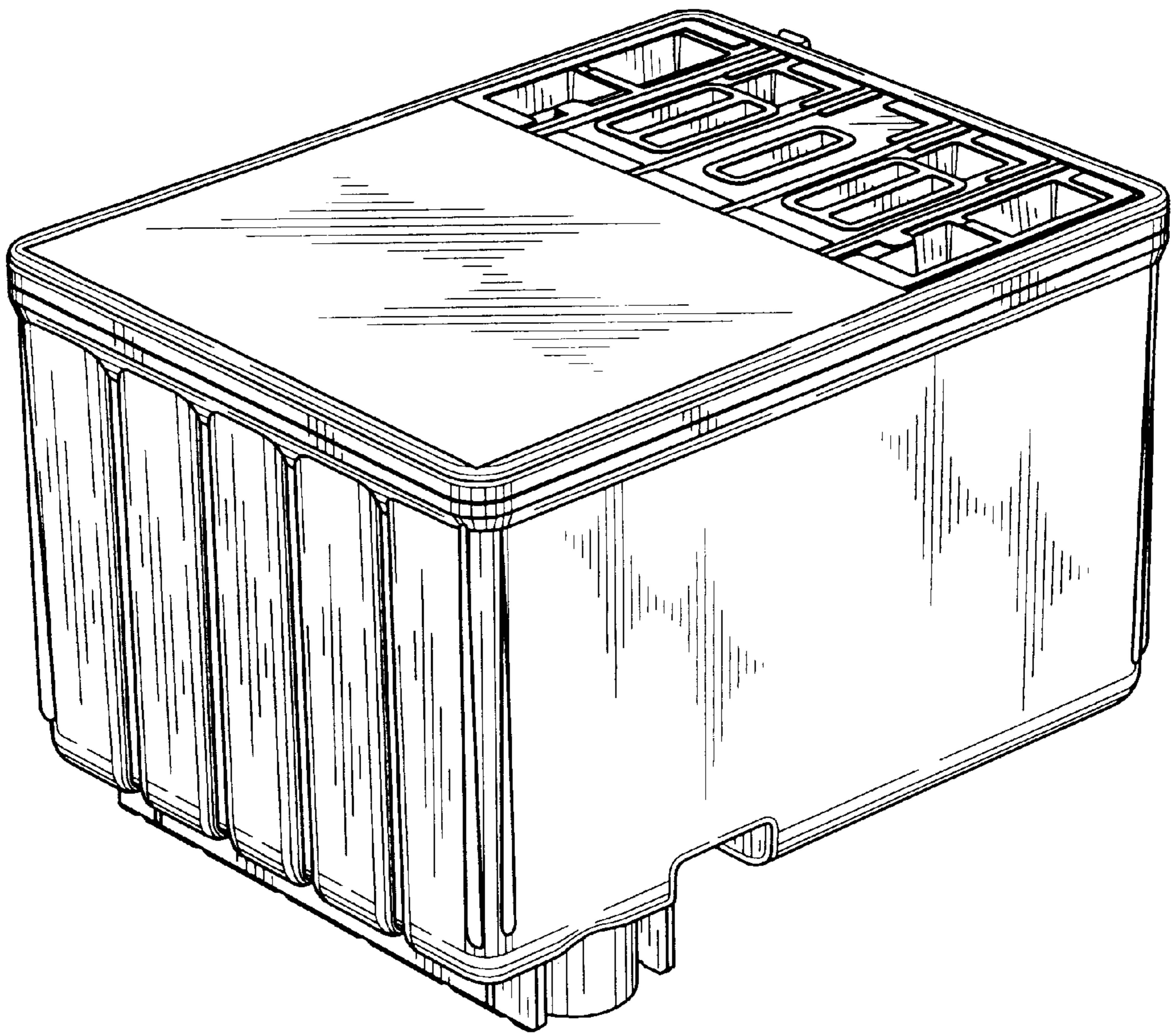
*FIG. 6*



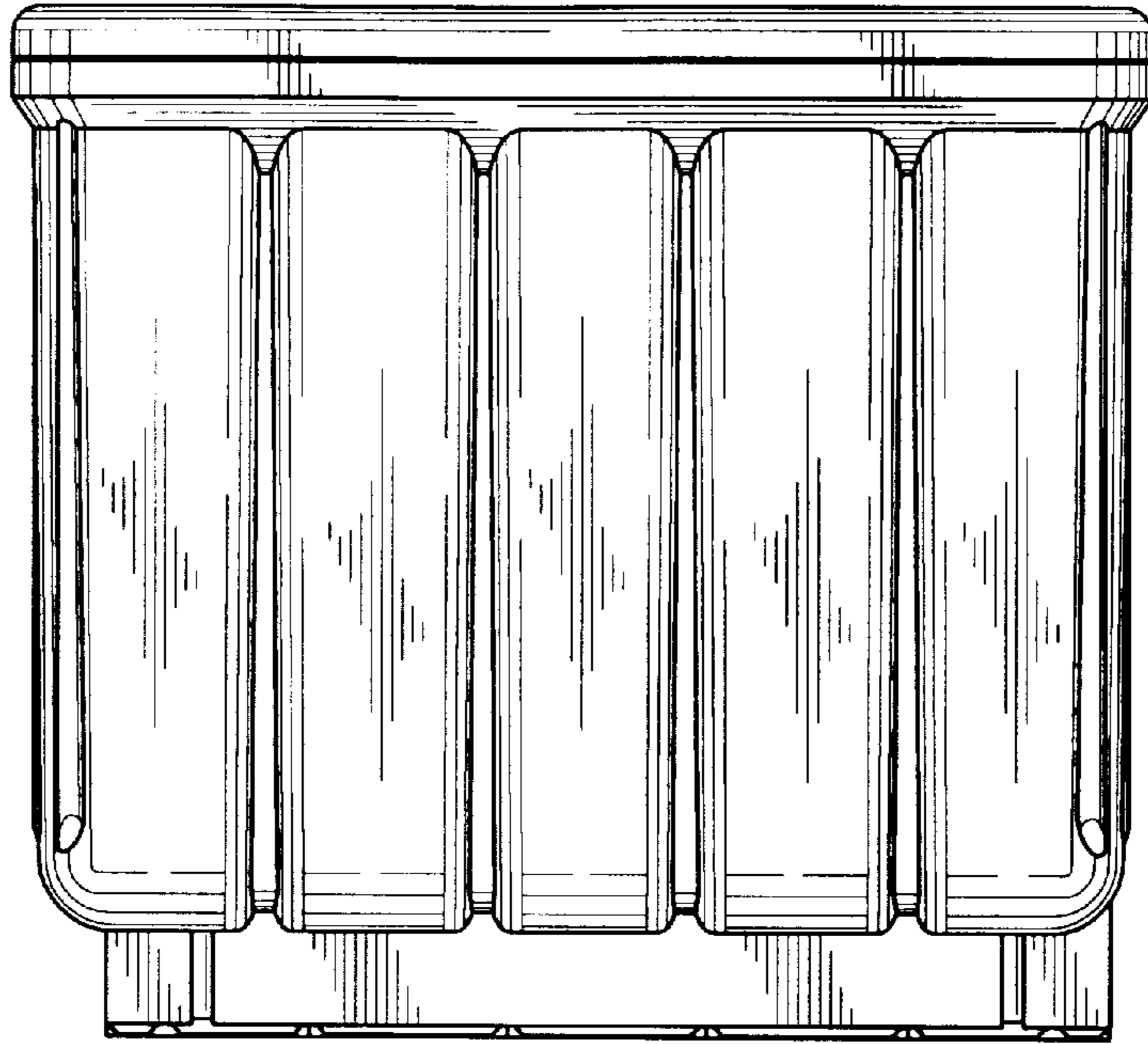
*FIG. 7*



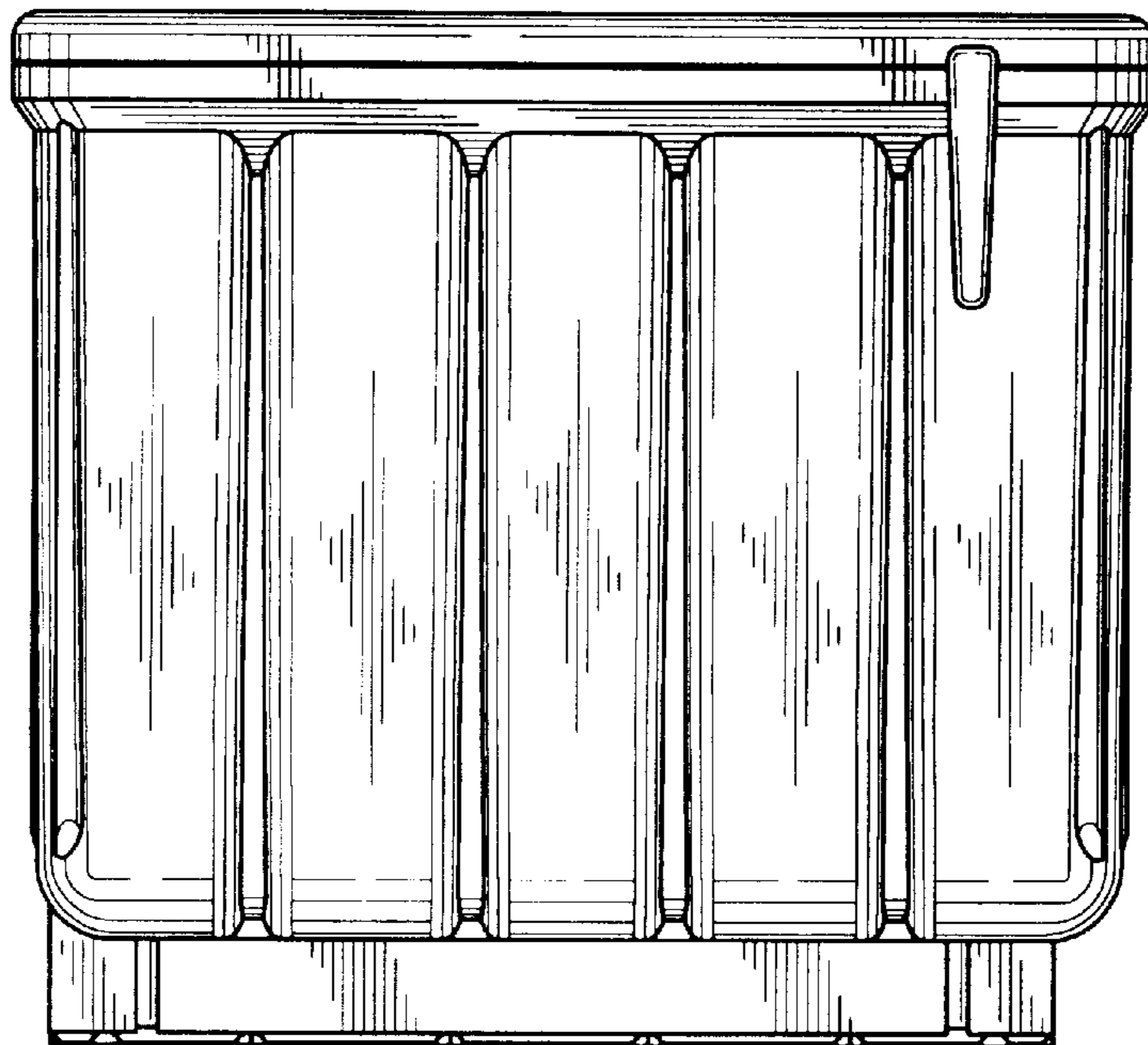
*FIG. 8*



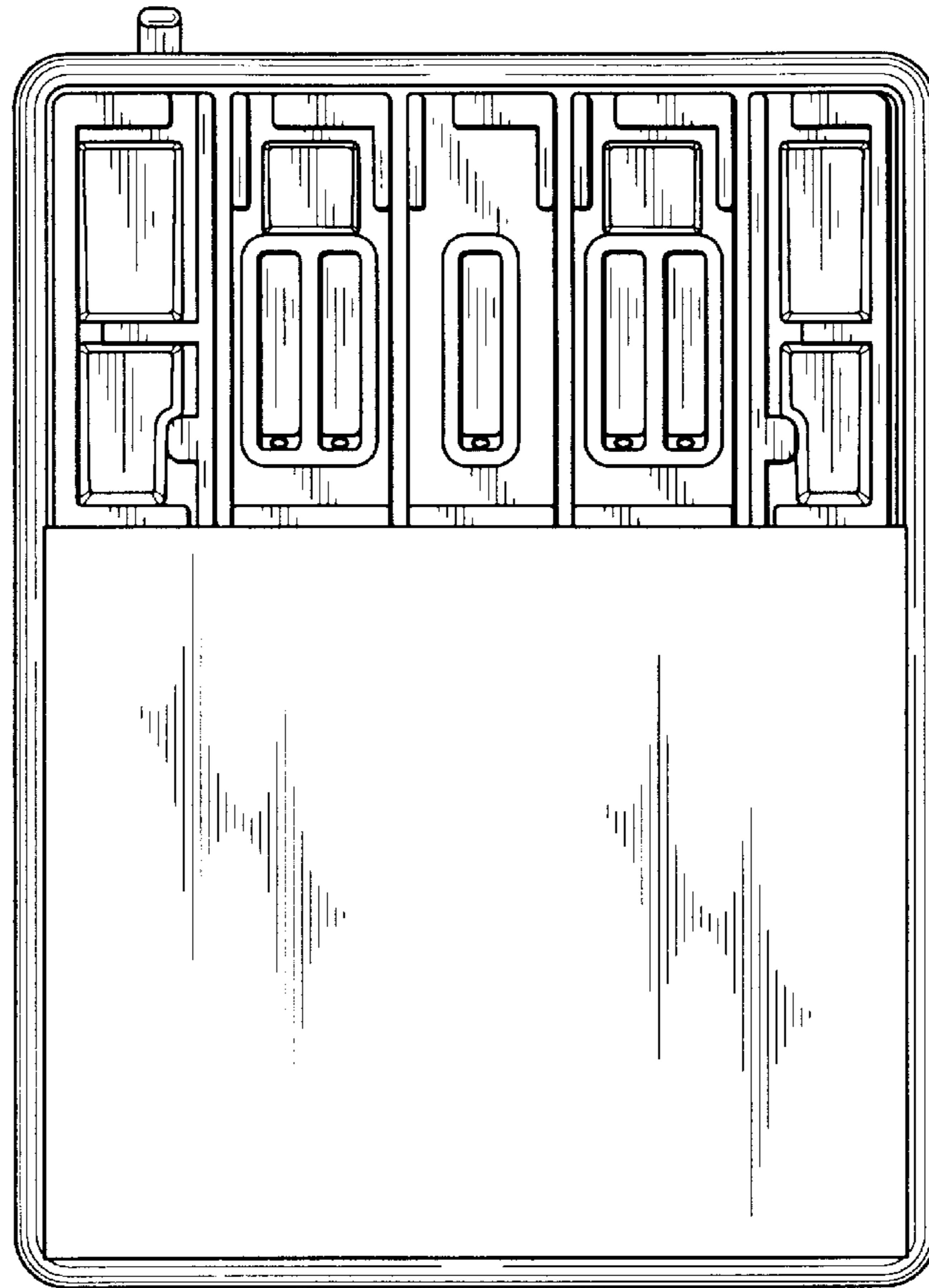
*FIG. 9*



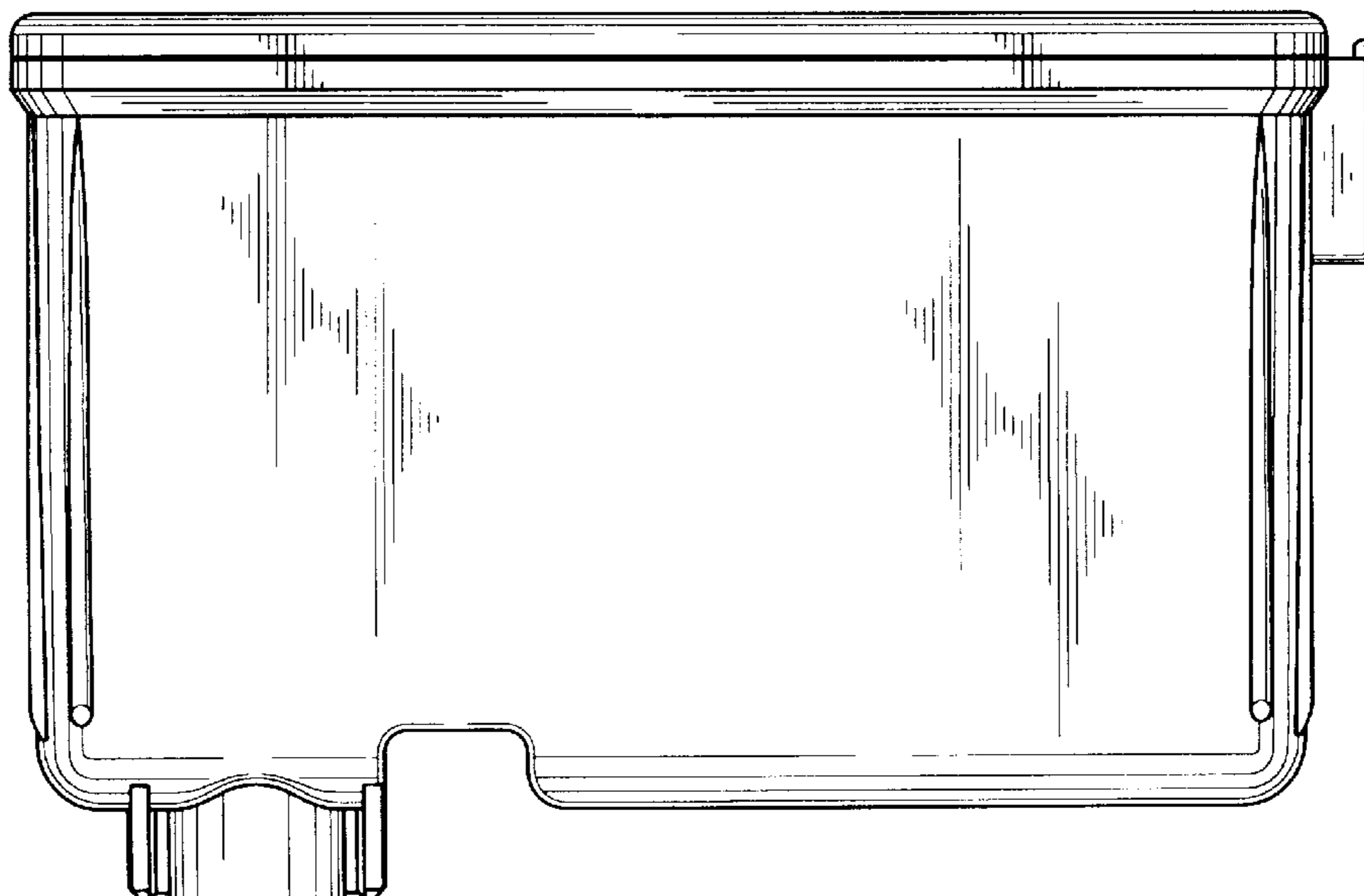
*FIG. 10*



*FIG. 11*

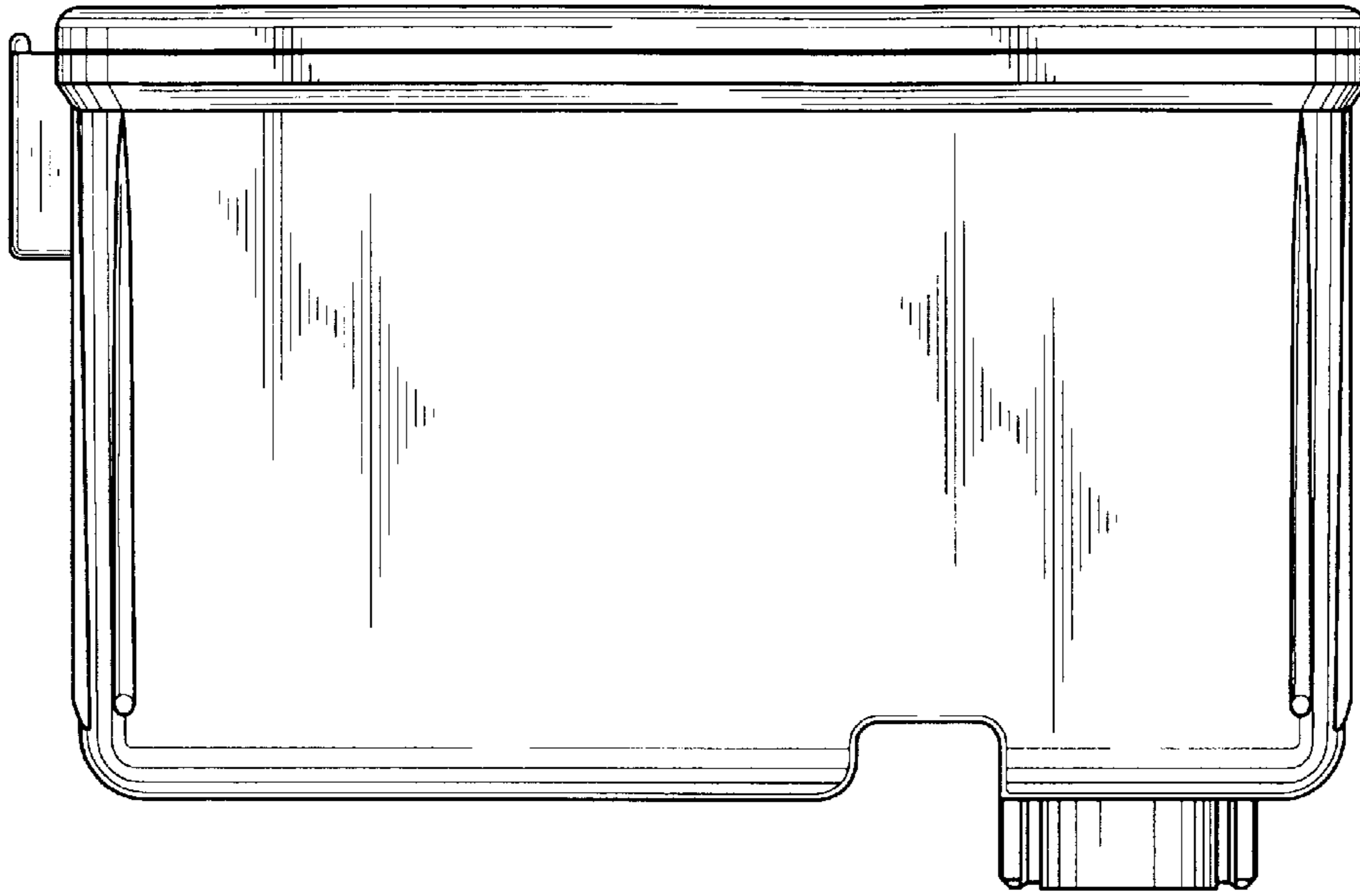


*FIG. 12*





*FIG. 13*



*FIG. 14*

