



US00D425101S

United States Patent [19] Wang

[11] **Patent Number: Des. 425,101**

[45] **Date of Patent: ** May 16, 2000**

[54] **RIM OF GLASSES**

D. 413,616 9/1999 Wang D16/307

[76] Inventor: **Wen-Te Wang**, No. 246-1, Kang-Kou, Kang-Kou Tsun, An-Ting Hsiang, Tainan Hsien, Taiwan

Primary Examiner—Raphael Barkai
Attorney, Agent, or Firm—Rosenberg, Klein & Lee

[**] Term: **14 Years**

[57] **CLAIM**

The ornamental design for rim of glasses, as shown and described.

[21] Appl. No.: **29/111,314**

DESCRIPTION

[22] Filed: **Sep. 28, 1999**

[51] **LOC (7) Cl.** **16-01**

[52] **U.S. Cl.** **D16/307**

[58] **Field of Search** D16/101, 900, D16/300–330; 351/41, 44, 51, 52, 158; 446/97, 268, 371; D21/659–661, 606, 609

FIG. 1 is a perspective view of rim of glasses showing my new design;

FIG. 2 is a front elevation view thereof;

FIG. 3 is a rear elevation view thereof;

FIG. 4 is a left side elevation view thereof;

FIG. 5 is a right side elevation view thereof;

FIG. 6 is a top plan view thereof;

FIG. 7 is an underneath plan view thereof; and,

FIG. 8 is a perspective view thereof, the broken lines shown are for illustrative purposes only and form no part of the claimed design.

[56] **References Cited**

U.S. PATENT DOCUMENTS

D. 393,652 4/1998 Wang D16/307
D. 396,873 8/1998 Wang D16/307
D. 413,347 8/1999 Wang D16/307

1 Claim, 3 Drawing Sheets

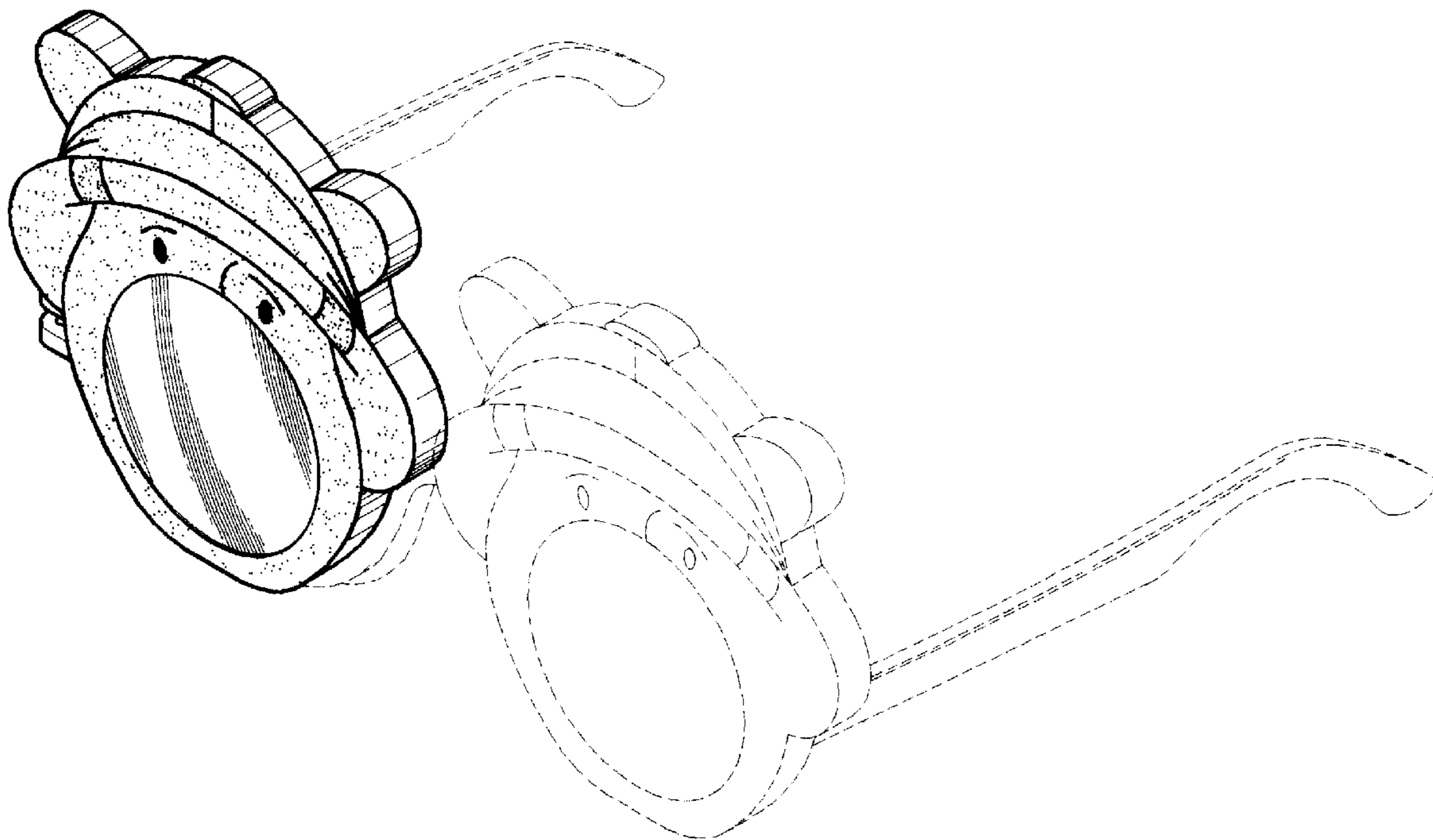

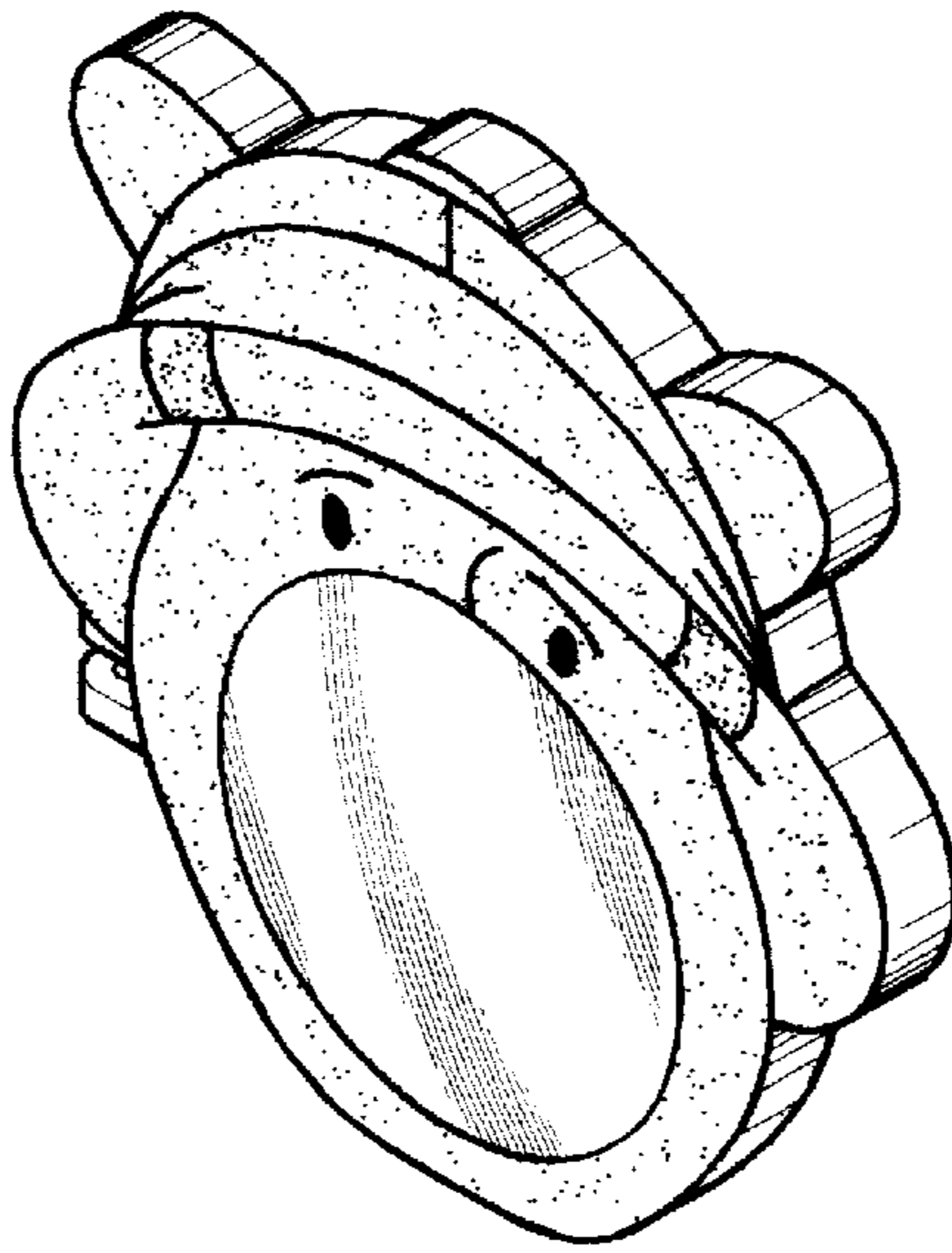

FIG. 1

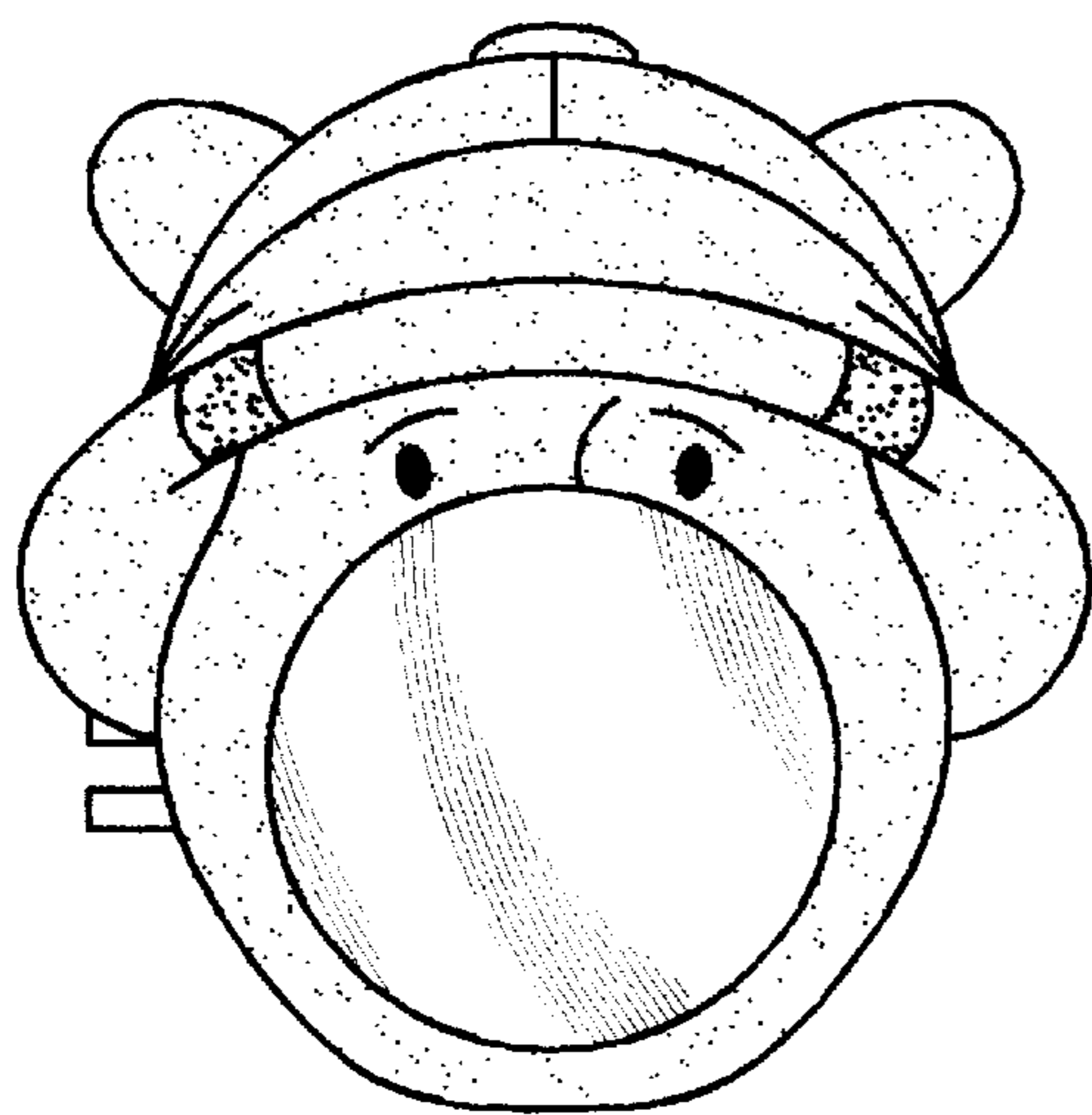

FIG. 2

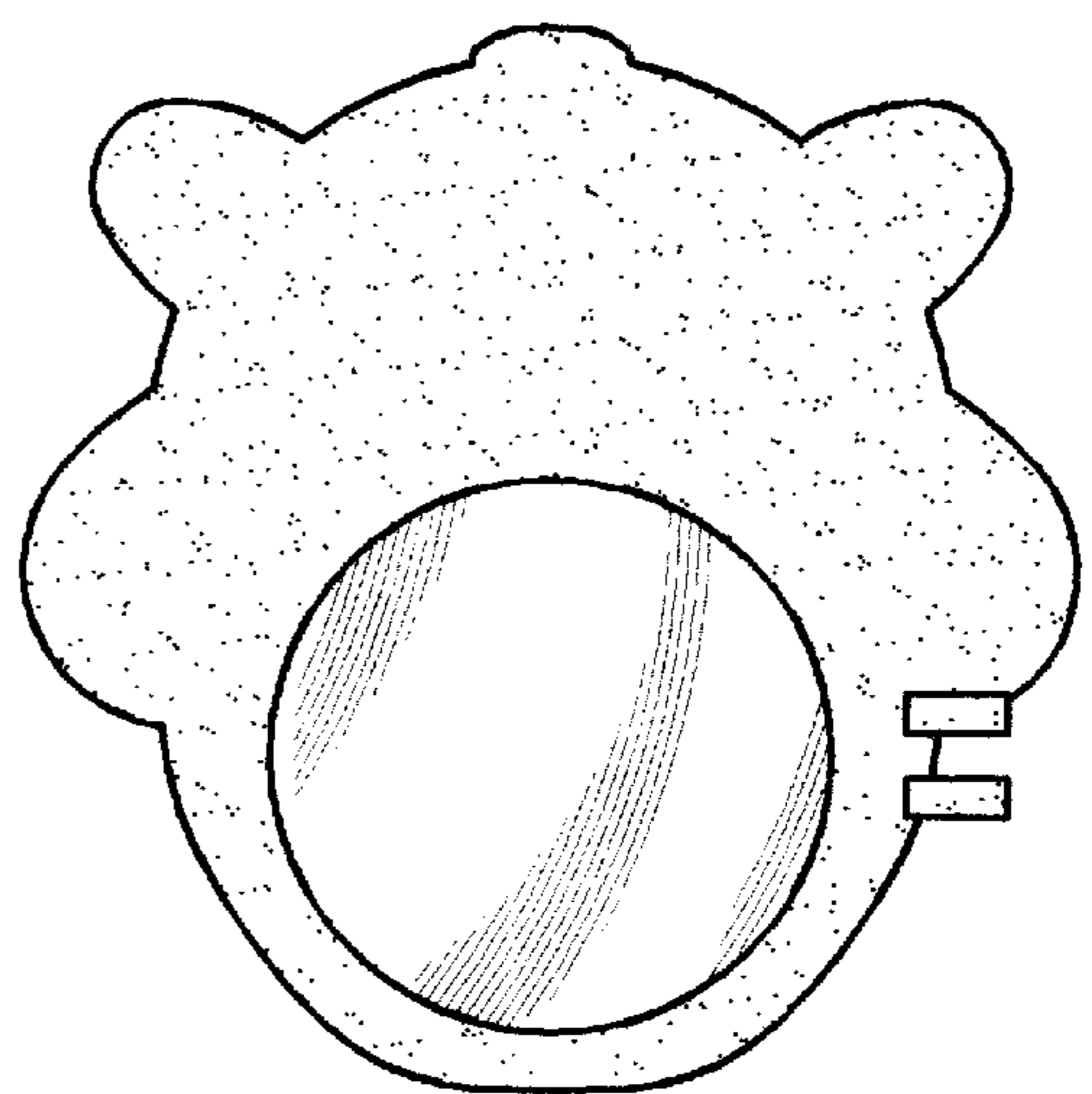

FIG. 3

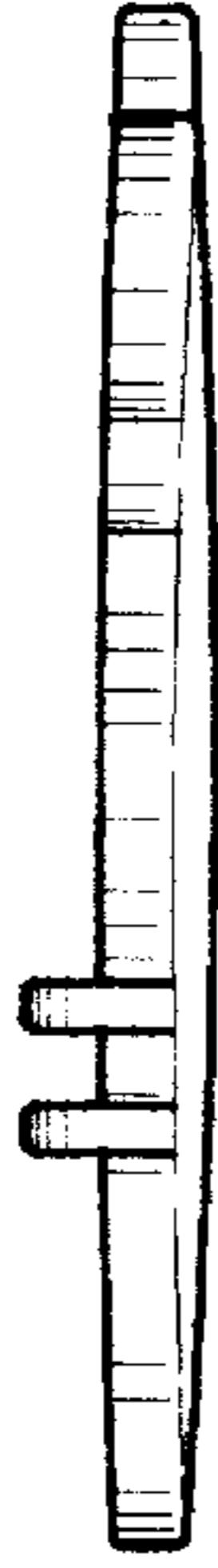

FIG. 4



FIG. 5



FIG. 6

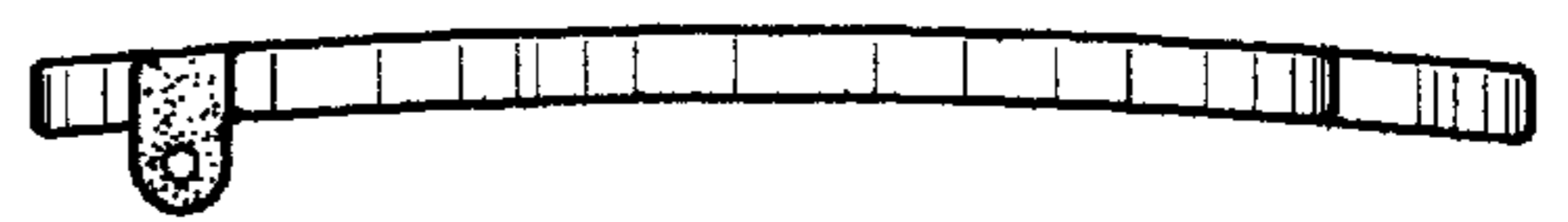

FIG. 7

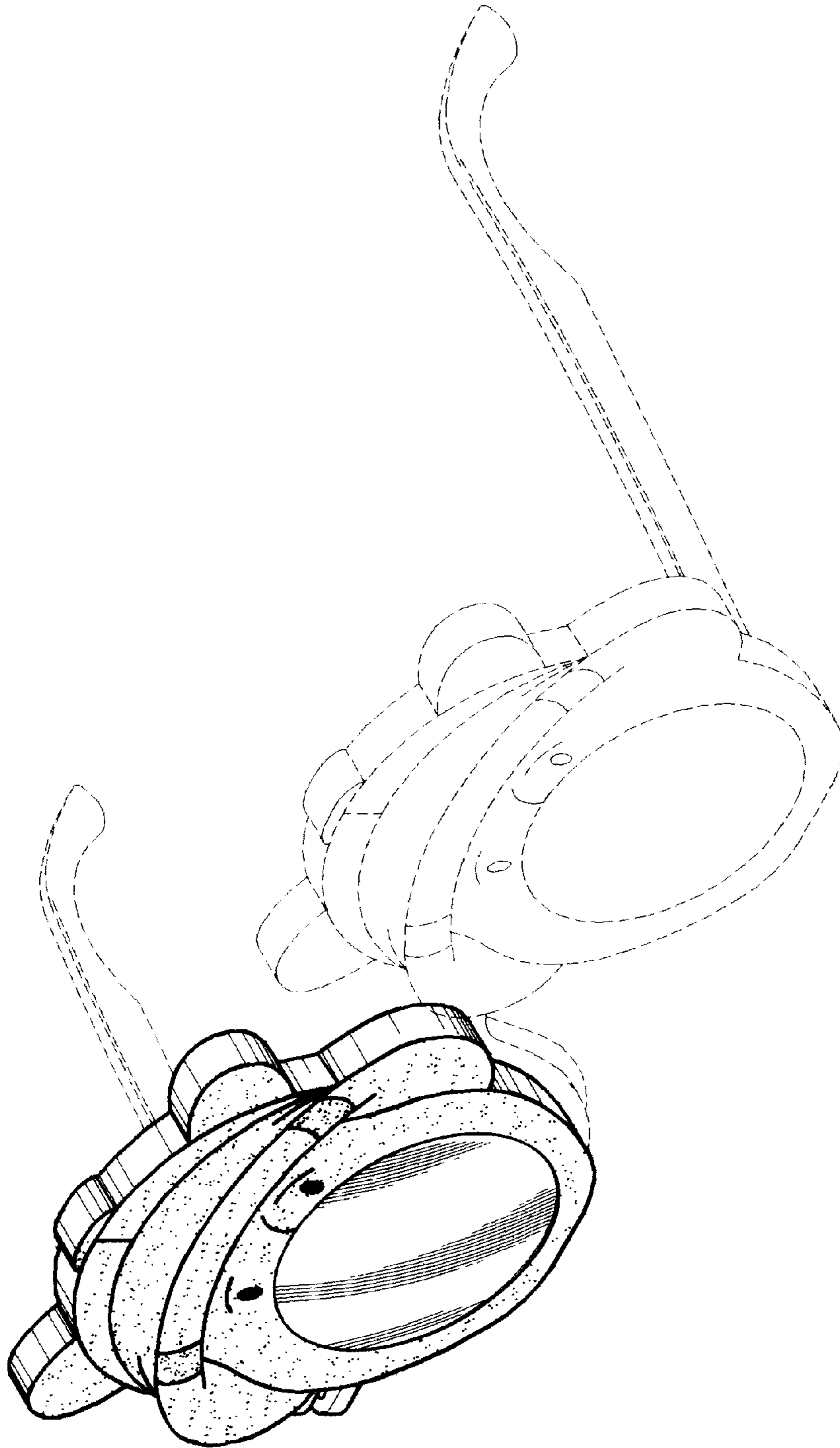

FIG. 8