



US00D424978S

United States Patent [19]
Yoshiguchi

[11] **Patent Number: Des. 424,978**

[45] **Date of Patent: ** *May 16, 2000**

[54] **BUCKLE**

[75] Inventor: **Manabu Yoshiguchi**, Yokohama, Japan

[73] Assignee: **Nifco Inc.**, Yokohama, Japan

[*] Notice: This patent is subject to a terminal disclaimer.

[**] Term: **14 Years**

[21] Appl. No.: **29/105,425**

[22] Filed: **May 24, 1999**

[30] **Foreign Application Priority Data**

Nov. 26, 1998 [JP] Japan 10-33716

[51] **LOC (7) Cl.** **02-07**

[52] **U.S. Cl.** **D11/218**

[58] **Field of Search** D11/200; D8/383;
24/196, 616, 625, 633, 650, 580, 525, 174,
573.1

[56] **References Cited**

U.S. PATENT DOCUMENTS

D. 341,105 11/1993 Lovato D11/218
D. 385,826 11/1997 Anscher D11/200
5,590,444 1/1997 Krauss 24/625

Primary Examiner—Ralf Seifert
Attorney, Agent, or Firm—Kaensaka & Takeuchi

[57] **CLAIM**

The ornamental design for a buckle, as shown and described.

DESCRIPTION

FIG. 1 is a perspective view of a buckle showing my new design;
FIG. 2 is a perspective view thereof in a state that a male member thereof and a female member thereof are detached from each other and separately shown;
FIG. 3 is a front view of the female member of the buckle shown separately for convenience of illustration;
FIG. 4 is a rear view thereof;
FIG. 5 is a right side view thereof, the left side view thereof being symmetrical to the right side view;
FIG. 6 is a top plan view thereof;
FIG. 7 is a bottom plan view thereof;
FIG. 8 is a front view of the male member of the buckle shown separately for convenience of illustration;
FIG. 9 is a rear view thereof;
FIG. 10 is a right side view thereof, the left side view being symmetrical to the right side view;
FIG. 11 is a top plan view thereof; and,
FIG. 12 is a bottom plan view thereof.

1 Claim, 4 Drawing Sheets

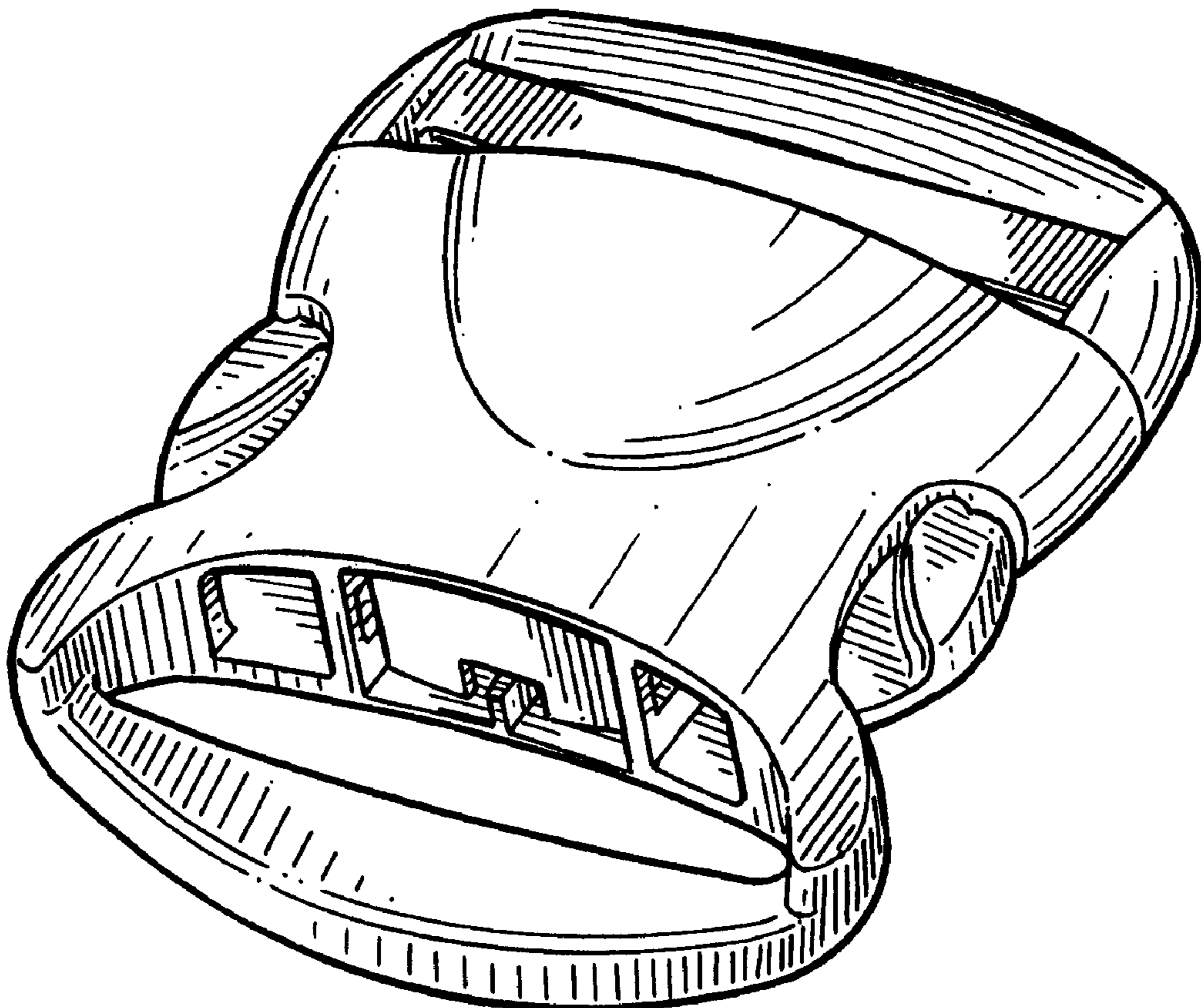

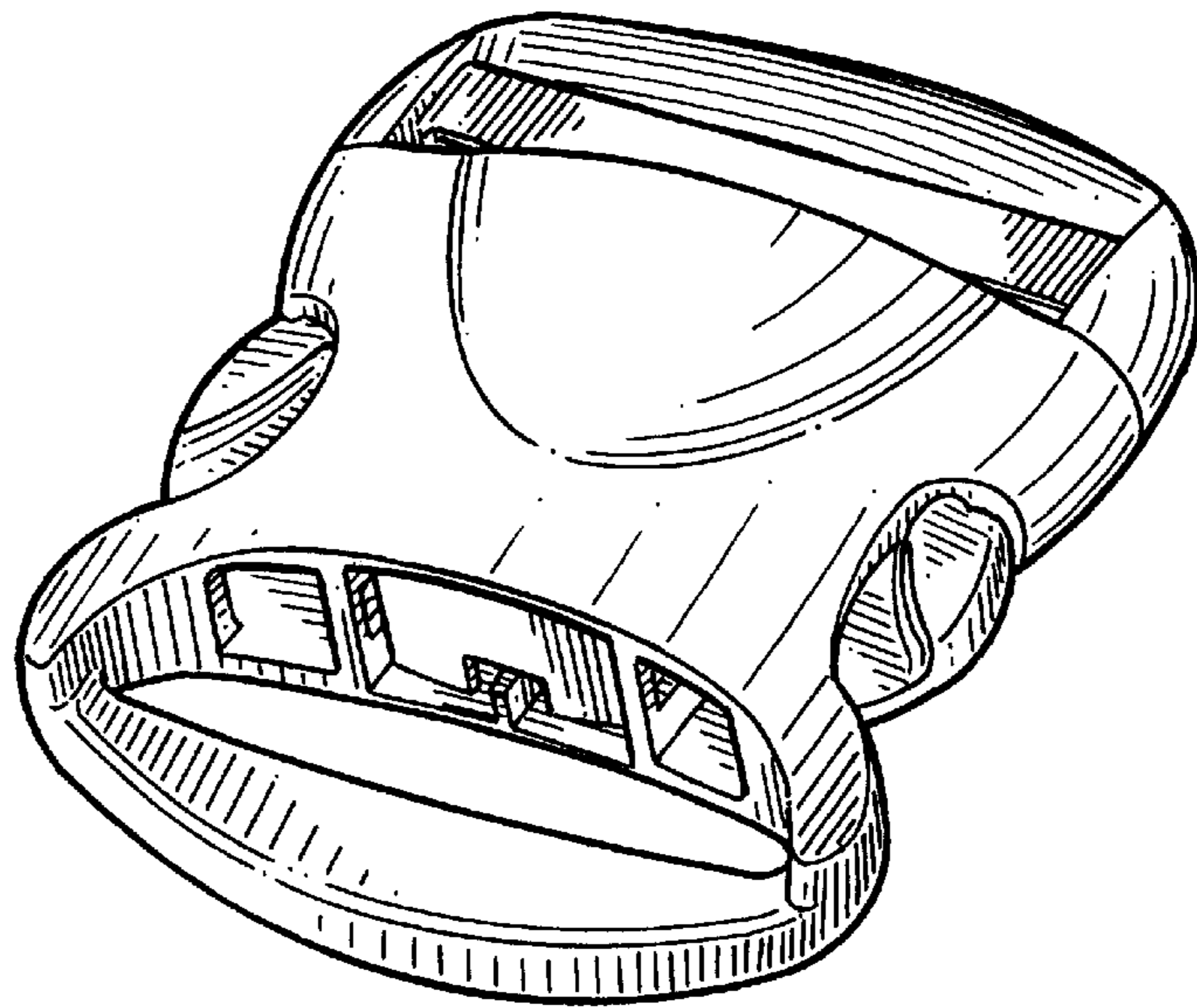

FIG. 1

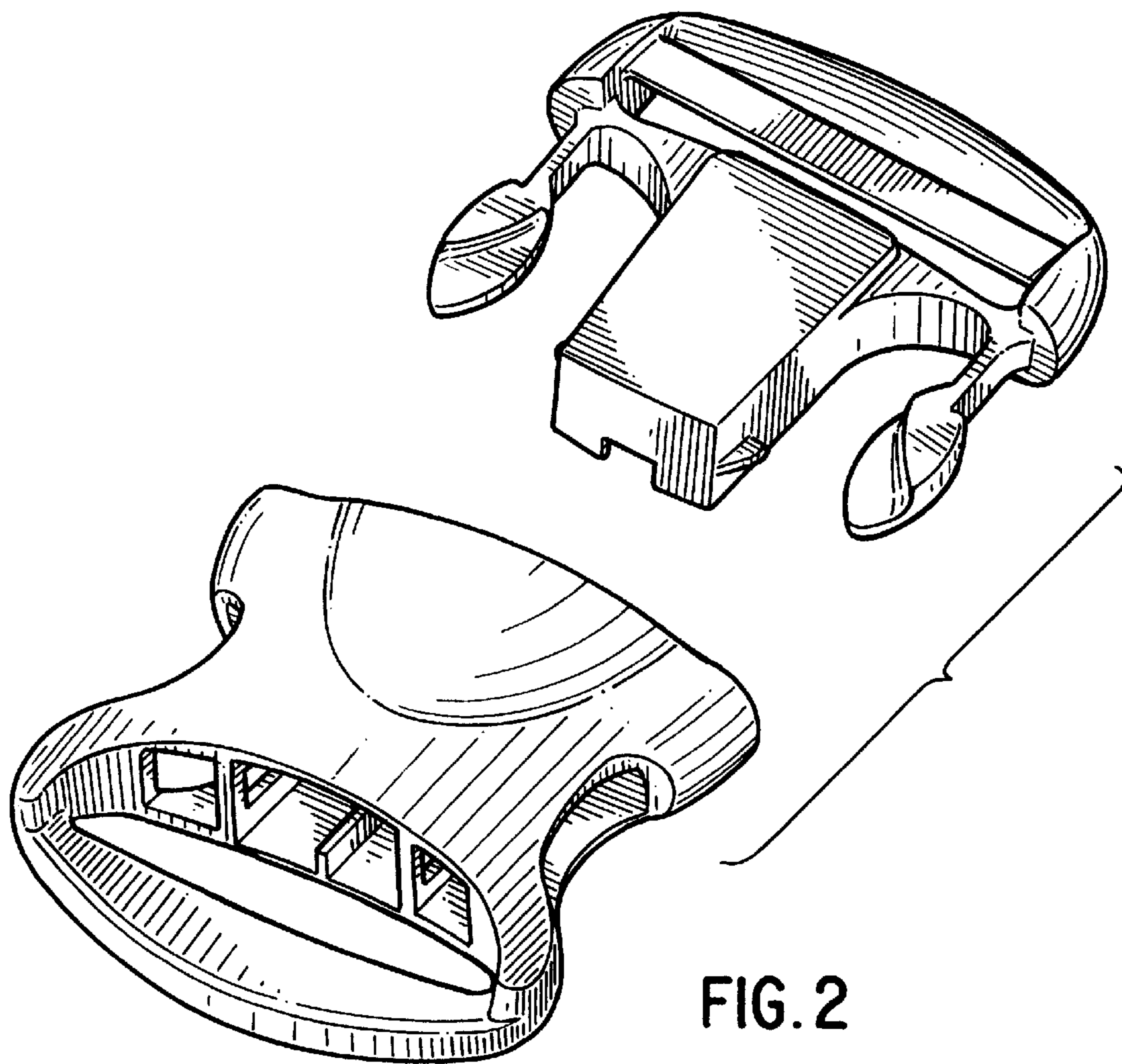

FIG. 2

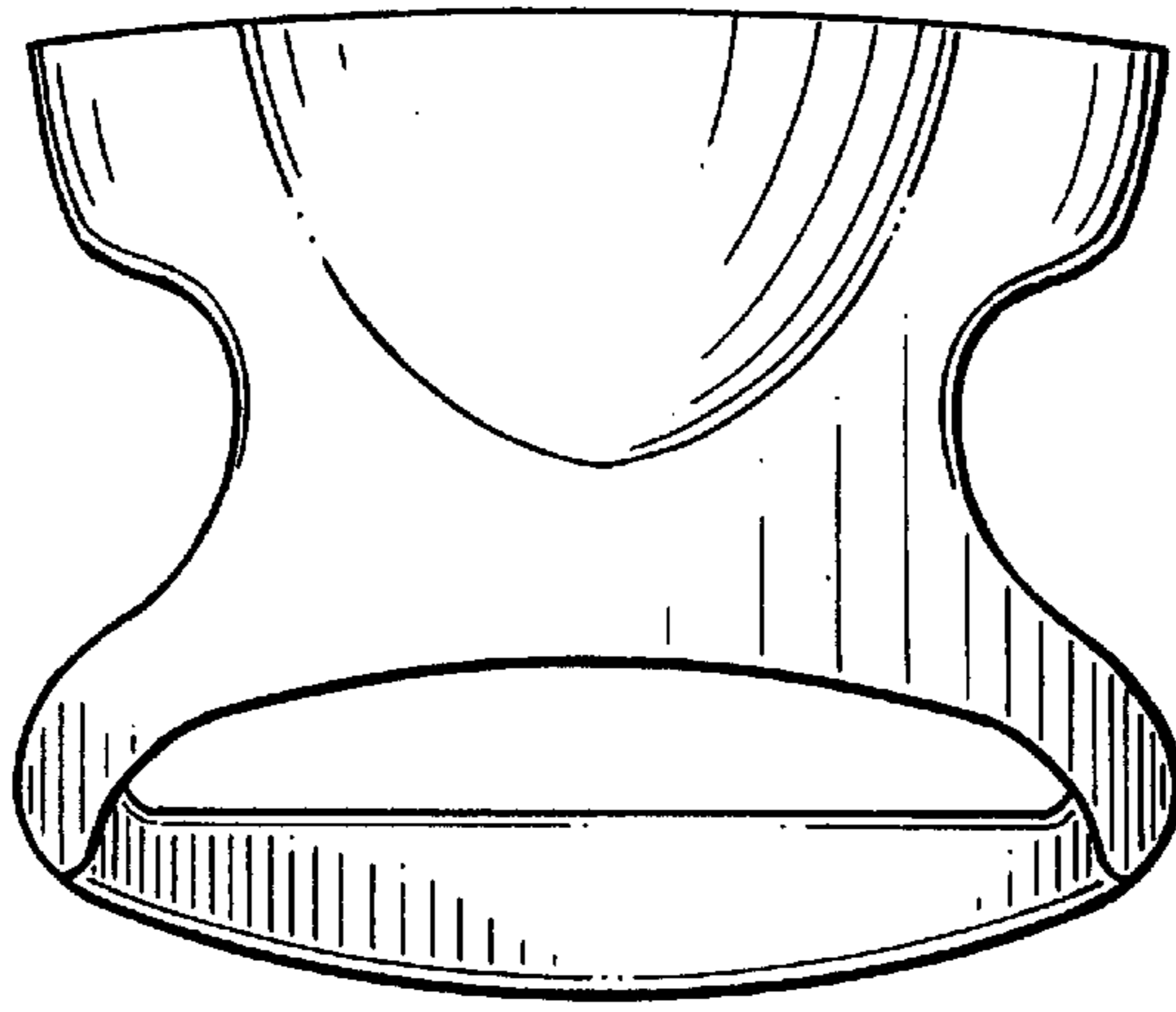

FIG. 3

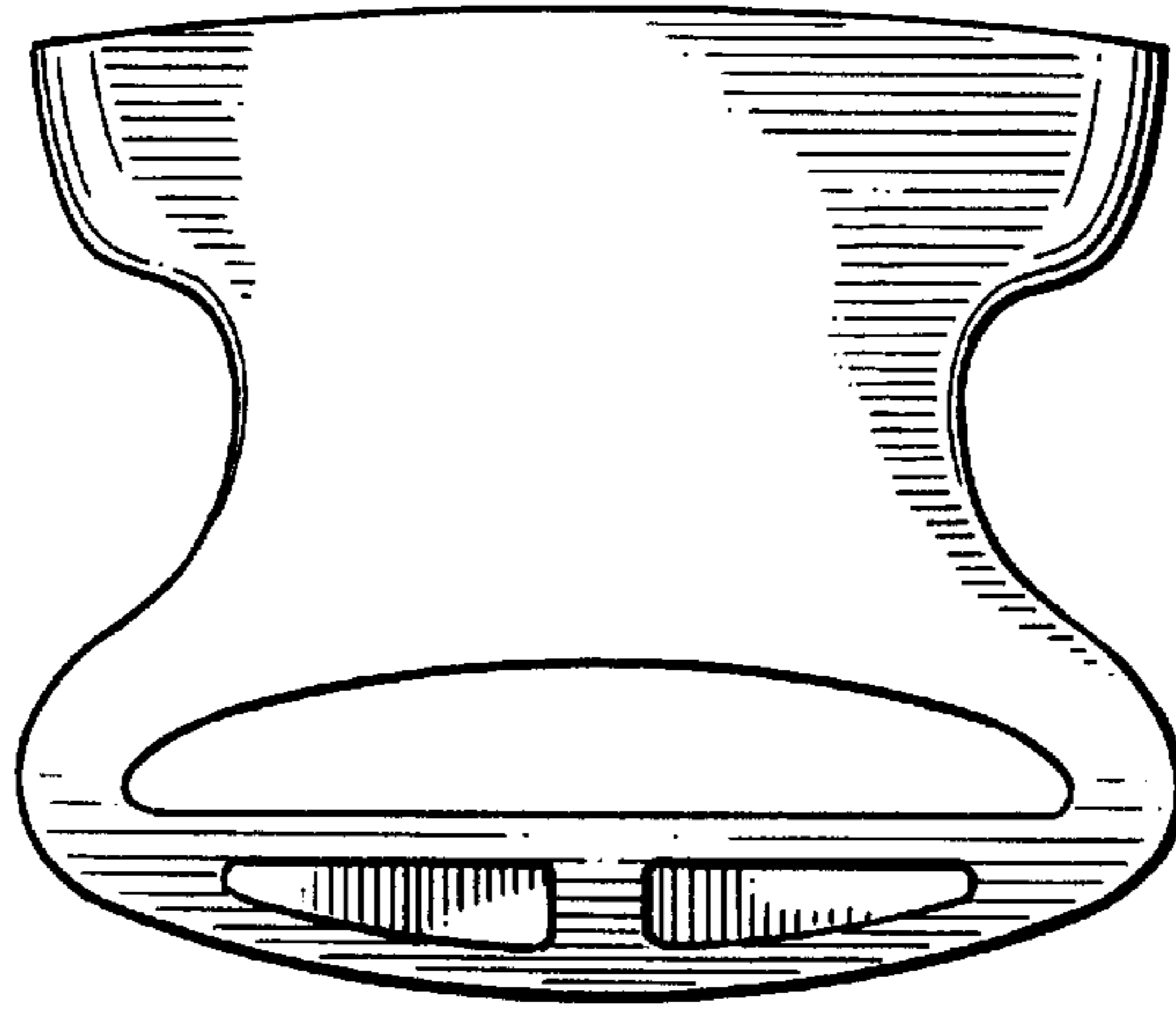

FIG. 4

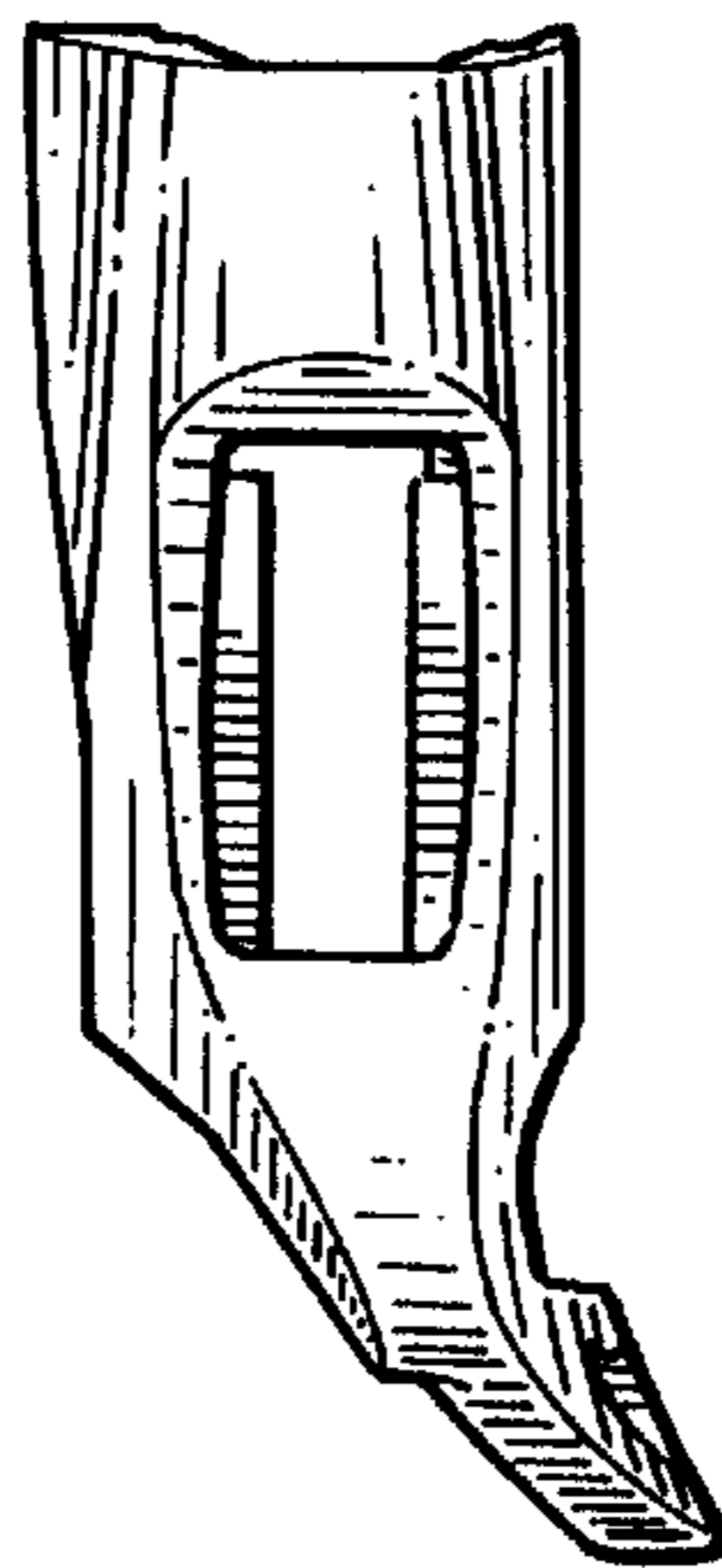

FIG. 5

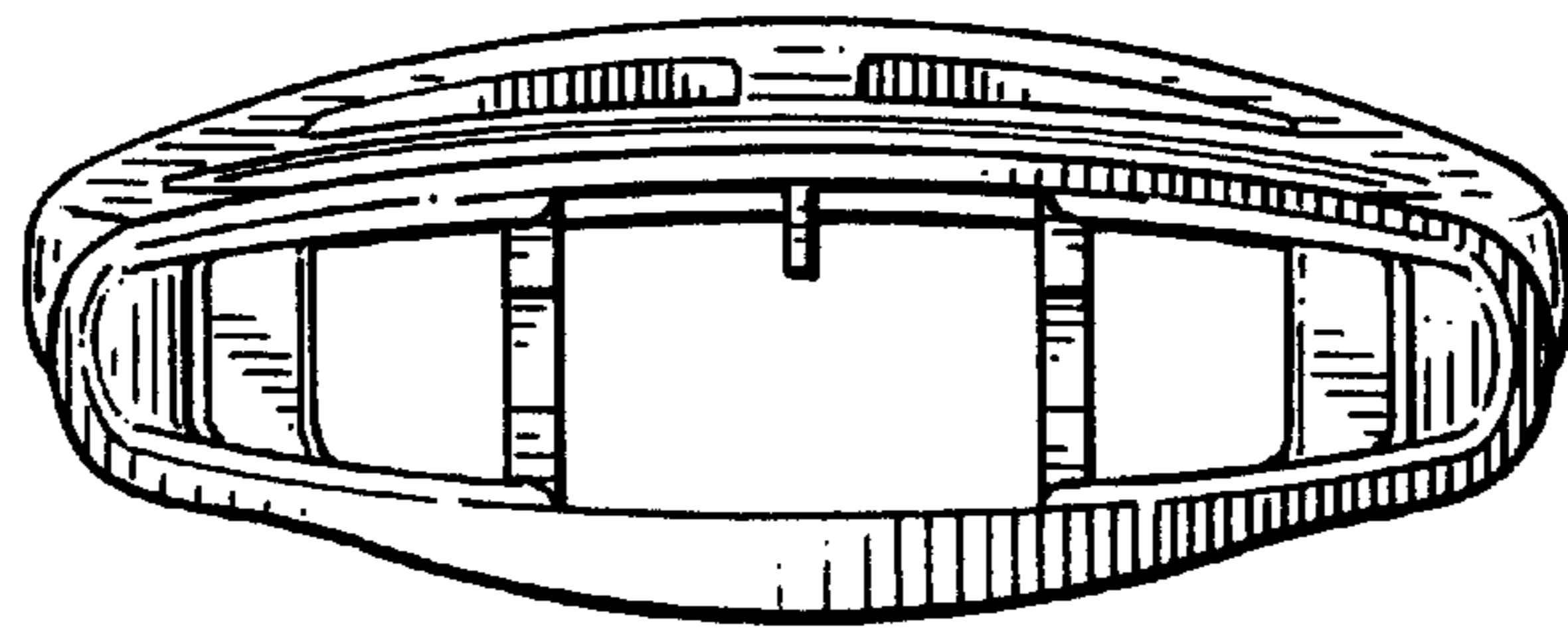

FIG. 6

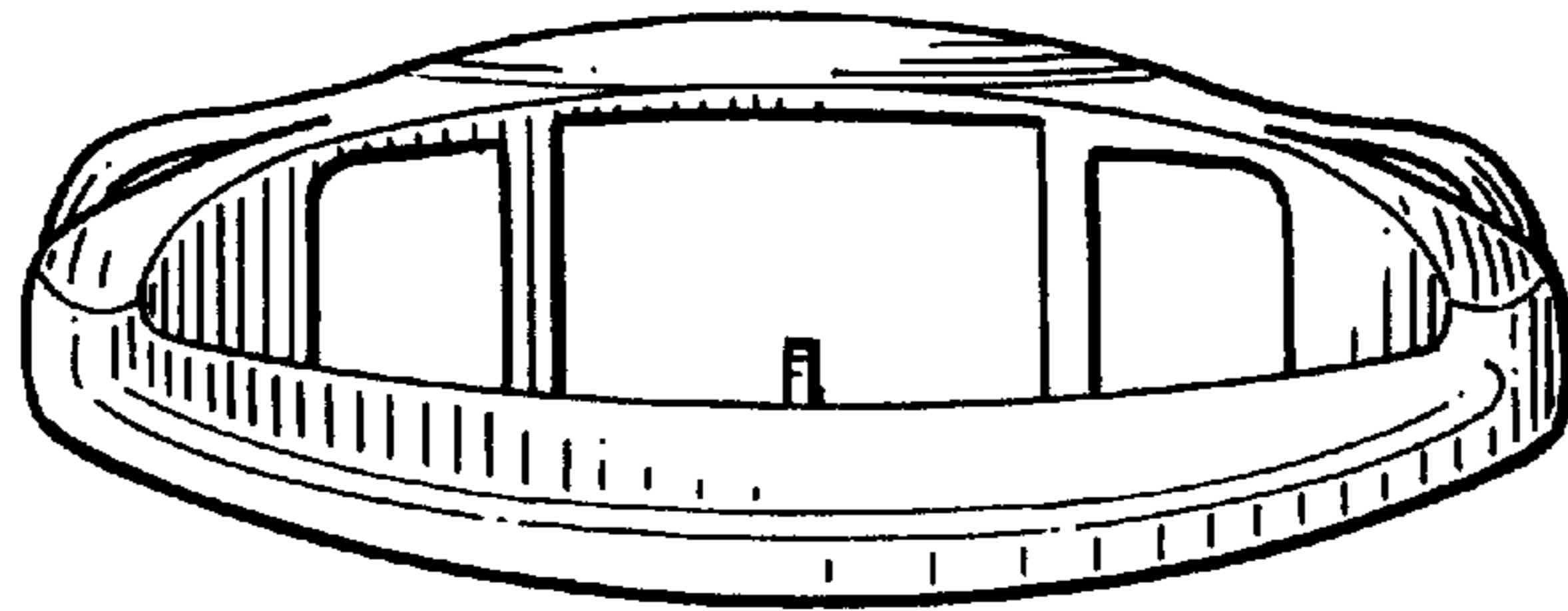

FIG. 7

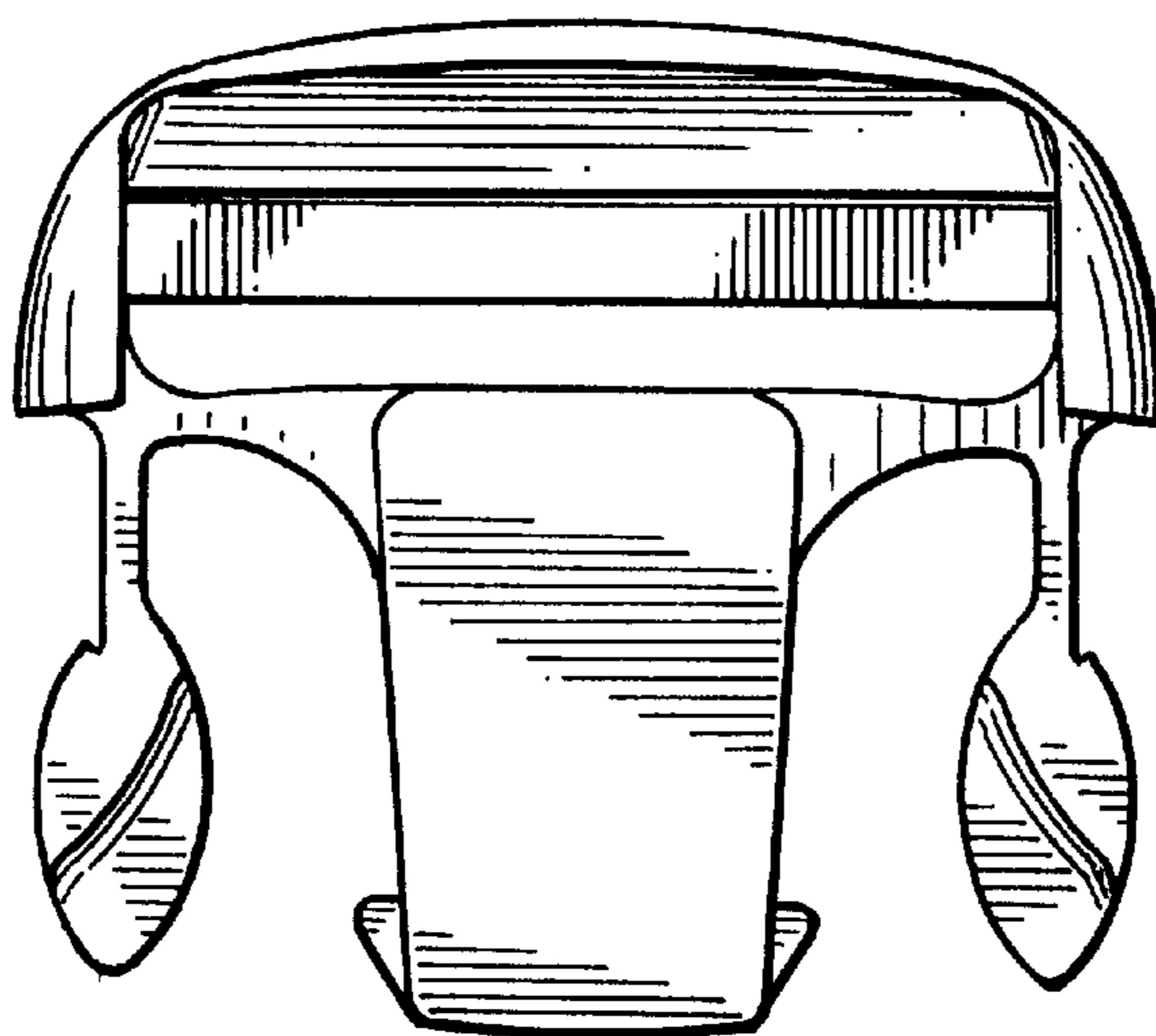

FIG. 8

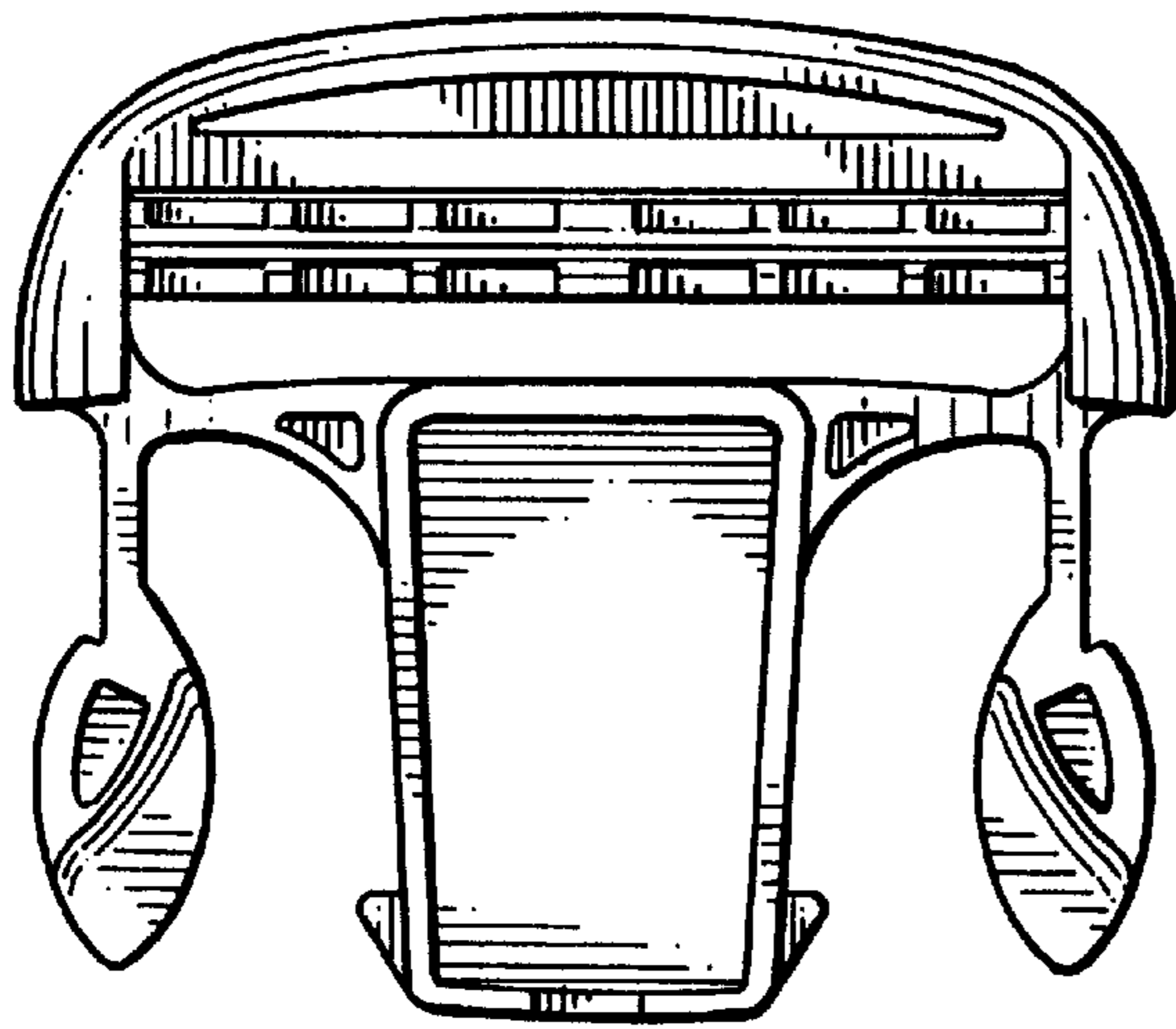

FIG. 9

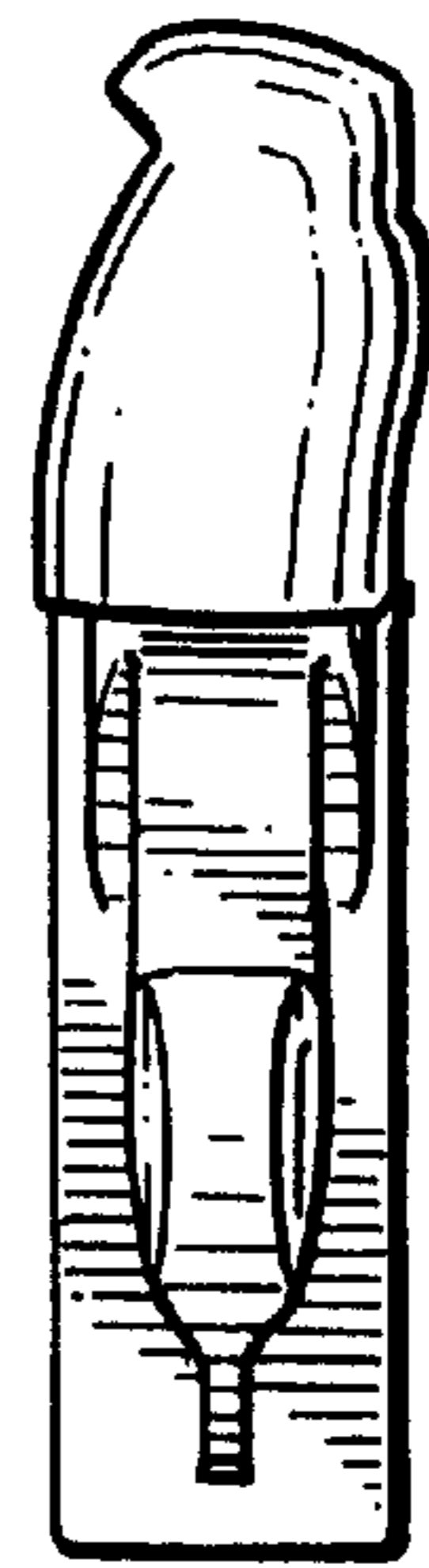

FIG. 10

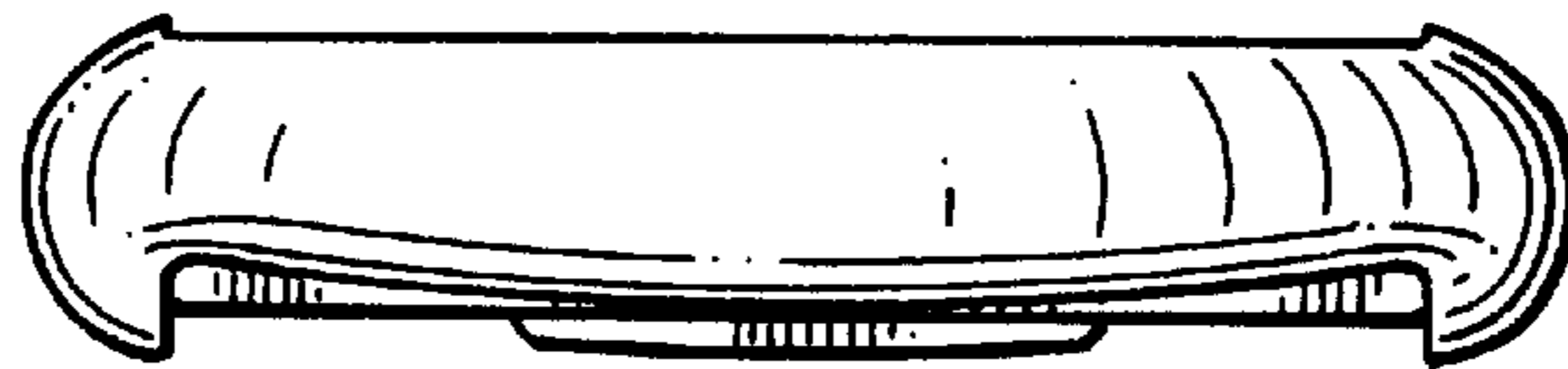

FIG. 11



FIG. 12