



US00D424935S

# United States Patent [19] Ristau

[11] Patent Number: Des. 424,935

[45] Date of Patent: \*\* May 16, 2000

[54] GIFT ITEM CONTAINER

5,626,232 5/1997 Volkert et al. .... 206/768

[75] Inventor: Mel Howard Ristau, Abilene, Tex.

### OTHER PUBLICATIONS

[73] Assignee: Mediagarden, Inc., Abilene, Tex.

<http://www.pegweb.com/artsncrafts/card.html>; Jun. 1, 1999.  
<http://www.pegweb.com/artsncrafts/letter.html>; Jun. 1, 1999.

[\*\*] Term: 14 Years

*Primary Examiner*—Ted Shooman  
*Assistant Examiner*—Carol Rademaker  
*Attorney, Agent, or Firm*—Locke Liddell & Sapp LLP

[21] Appl. No.: 29/099,661

[22] Filed: Jan. 26, 1999

[51] LOC (7) Cl. .... 09-03

[52] U.S. Cl. .... D9/430

[58] Field of Search ..... D9/337, 341, 346,  
D9/347, 414, 430-433; D19/1-4, 6-7; 229/103.2,  
115, 116.3

### [57] CLAIM

The ornamental design for a gift item container, as shown and described.

### DESCRIPTION

### [56] References Cited

#### U.S. PATENT DOCUMENTS

D. 82,863	12/1930	Warren	.....	D19/4
D. 272,806	2/1984	Handy et al.	.....	D9/414
D. 297,413	8/1988	Cantrell	.....	D9/305
D. 317,721	6/1991	Fiorillo et al.	.....	D9/430
D. 329,016	9/1992	Scarpa et al.	.....	D9/346
1,866,493	7/1932	Staats	.	
3,440,747	4/1969	Oliver	.....	40/126
4,201,331	5/1980	Austin	.....	229/39 R
5,054,611	10/1991	Russomanno et al.	.....	206/45.28
5,377,821	1/1995	Fierek	.....	206/44 R
5,613,312	3/1997	Crowell	.....	40/312

FIG. 1 is a front view of a first embodiment of the new design in a closed position.

FIG. 2 is a back view thereof.

FIG. 3 is a top view thereof.

FIG. 4 is a left side view thereof.

FIG. 5 is a right side view thereof.

FIG. 6 is a bottom view thereof.

FIG. 7 is a back view thereof in an open position; and, FIG. 8 is a front view thereof in an open position.

The broken line showing in FIGS. 7 & 8 represent fold lines only.

1 Claim, 3 Drawing Sheets

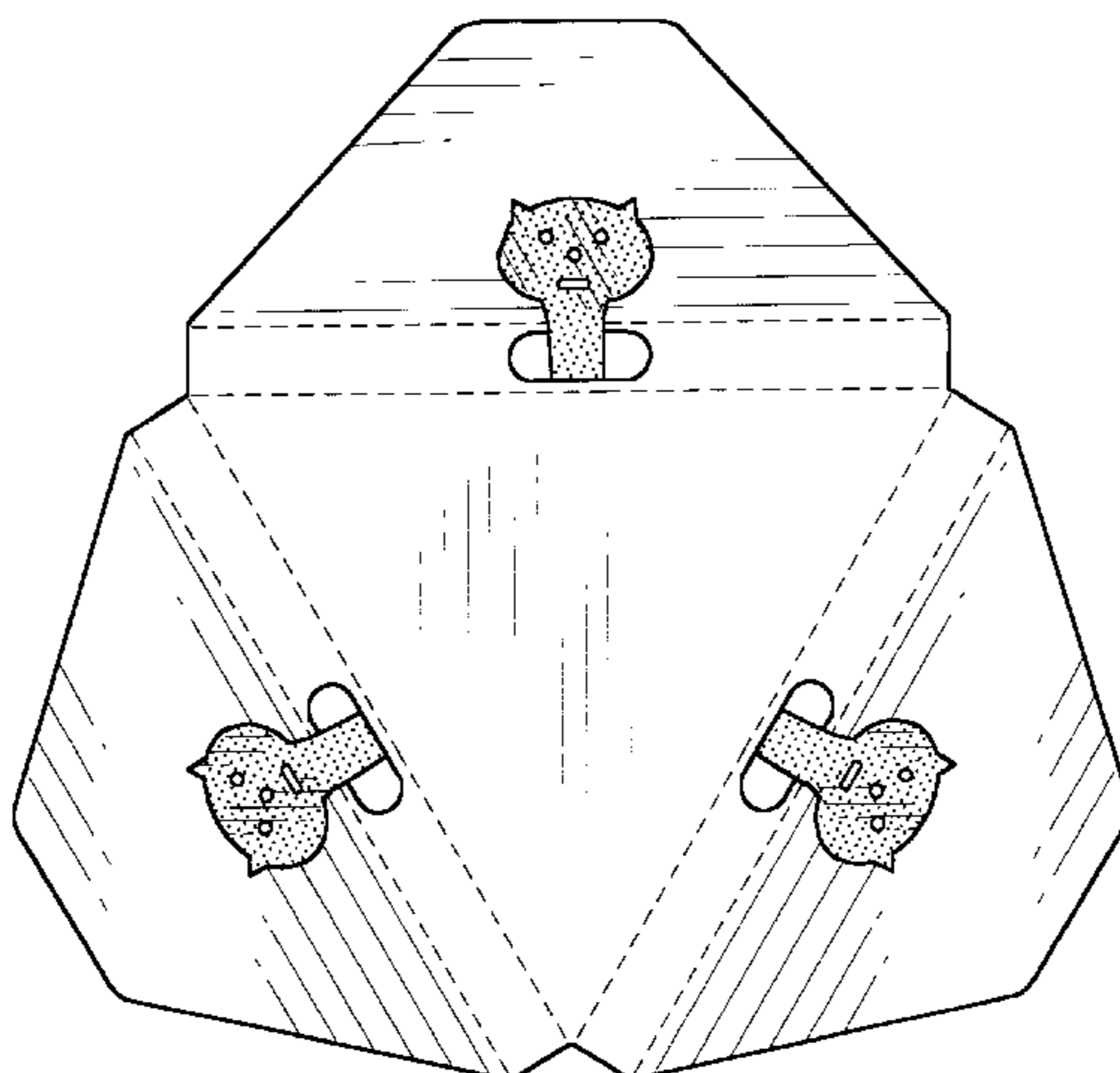
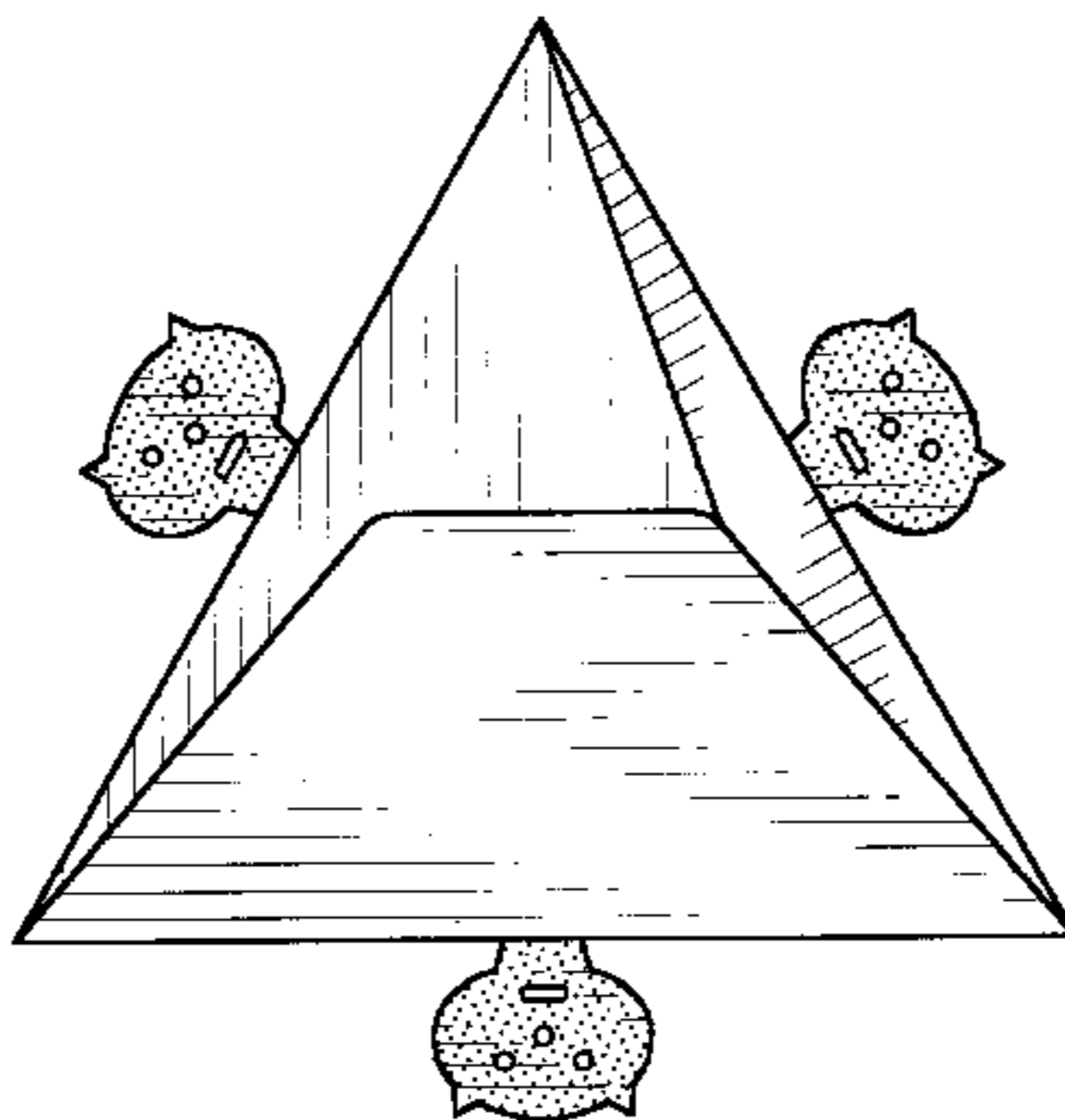

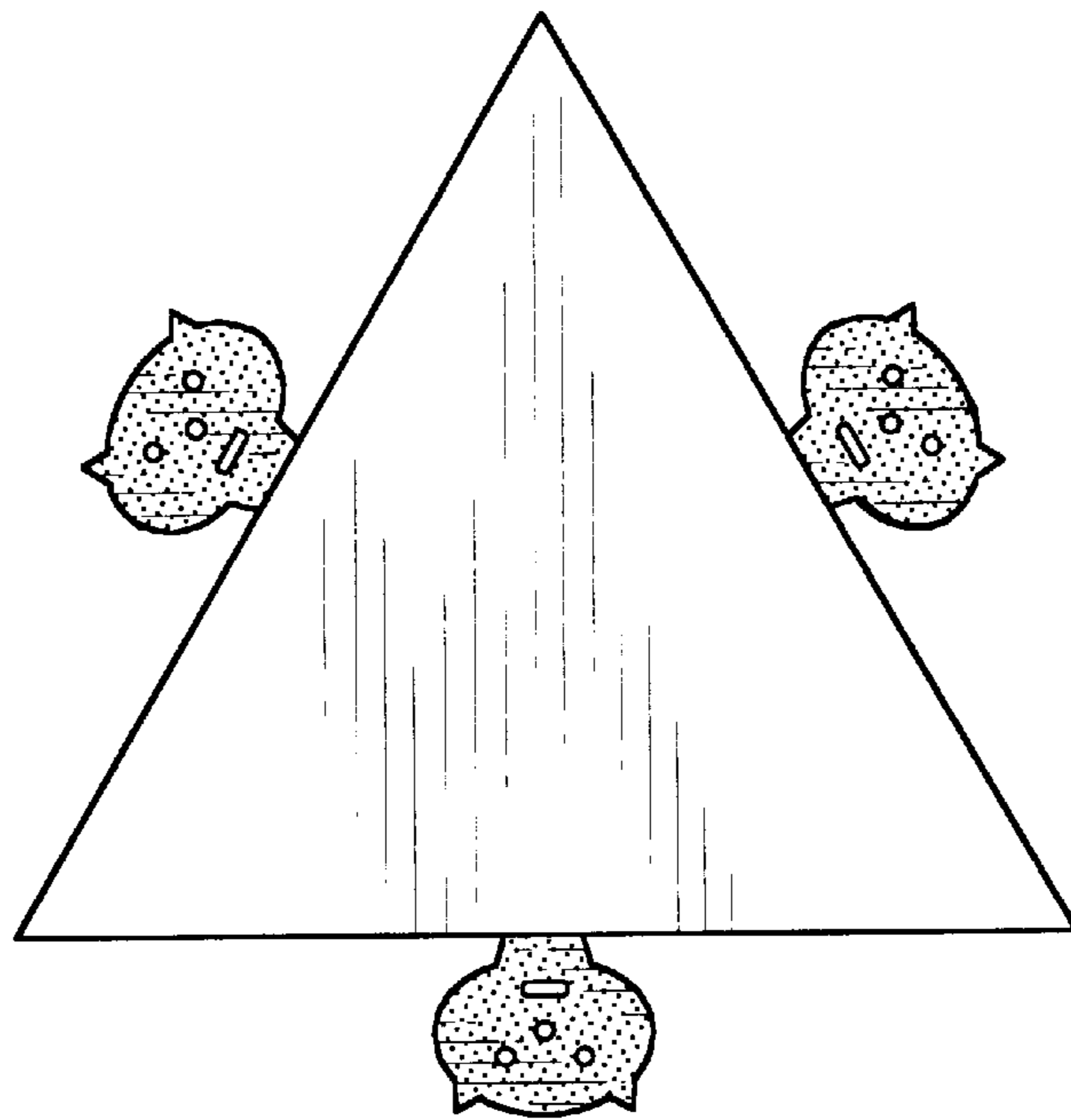

Fig. 1

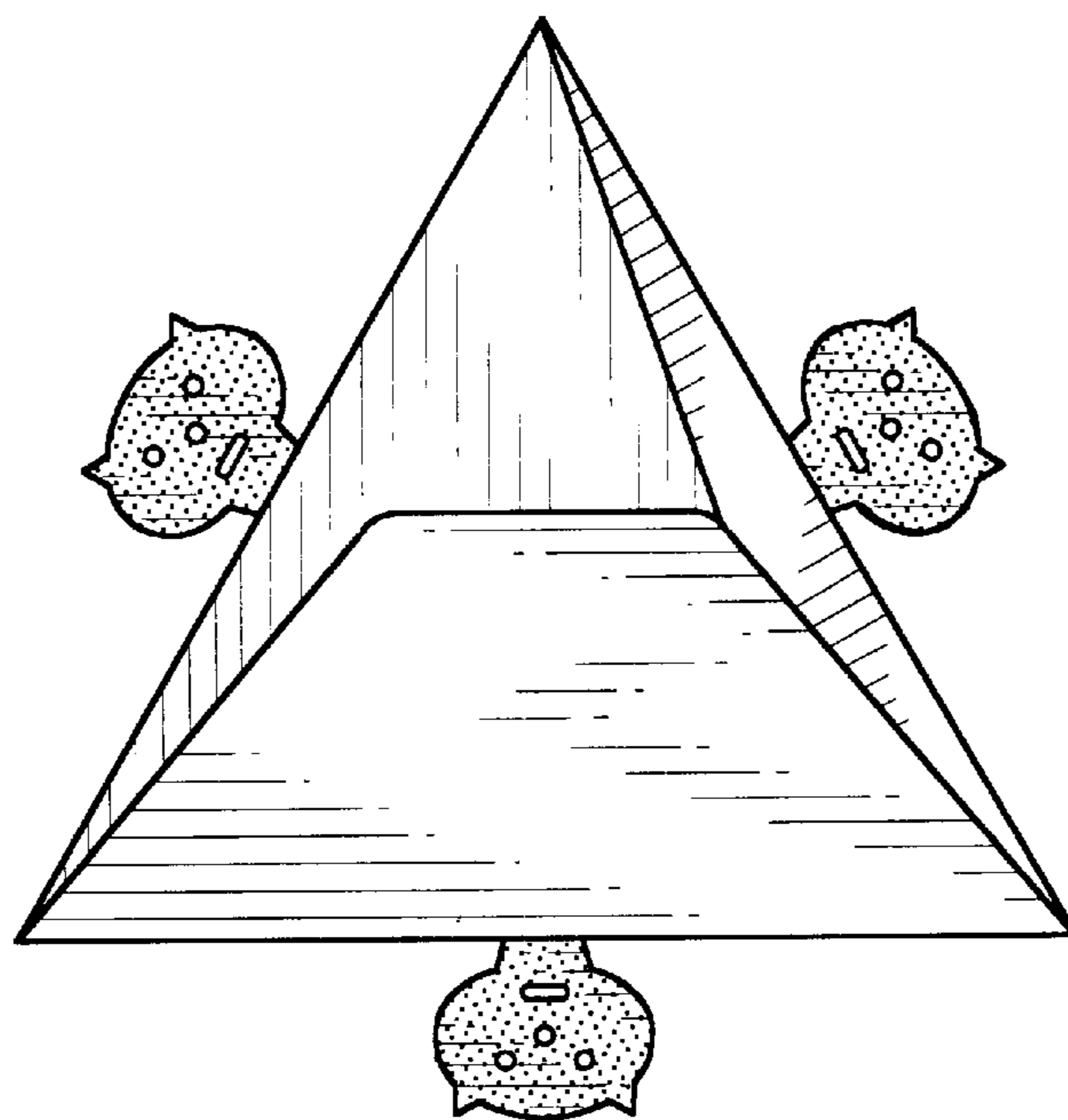

Fig. 2

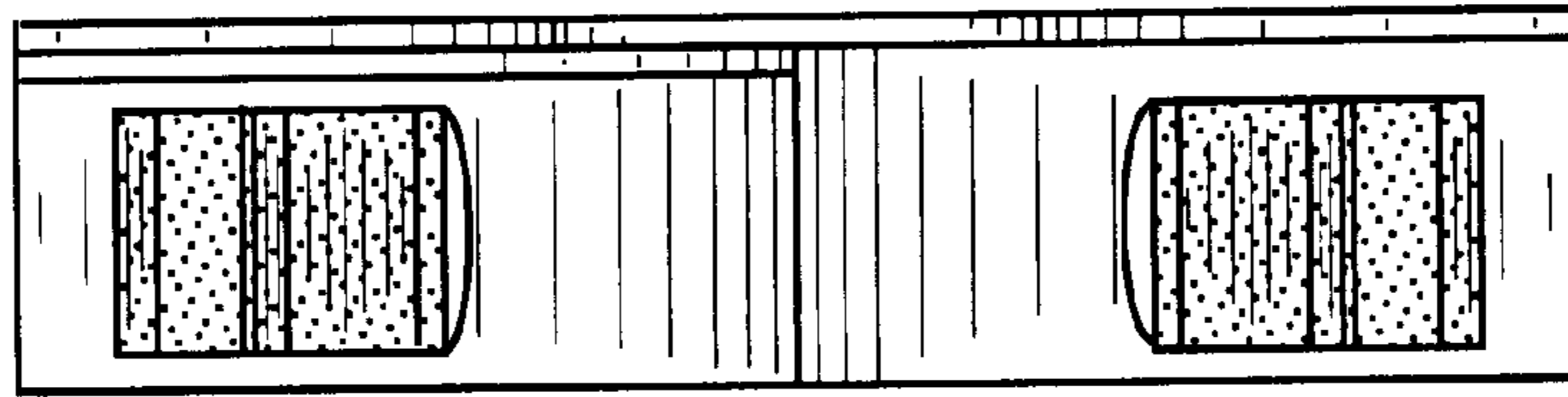

Fig. 3

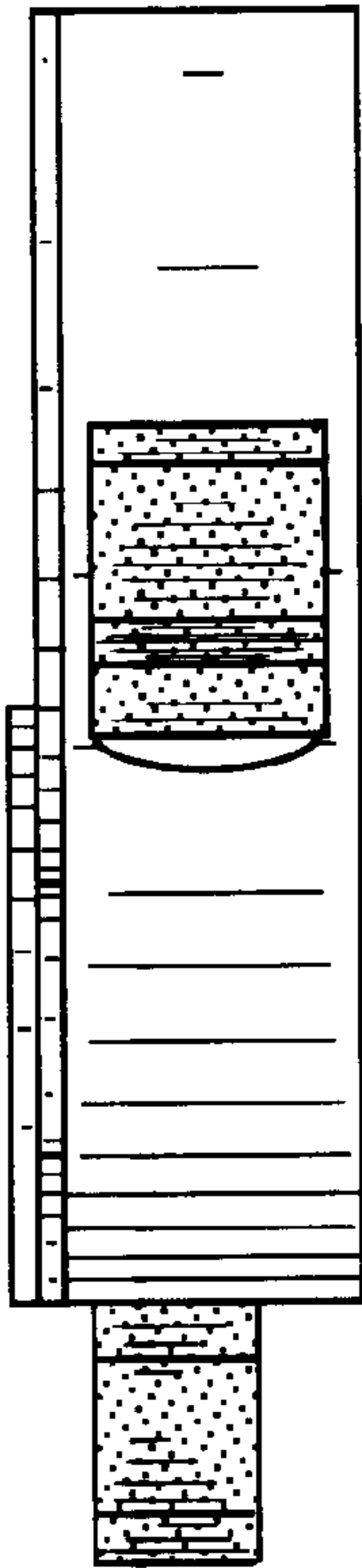

Fig. 4

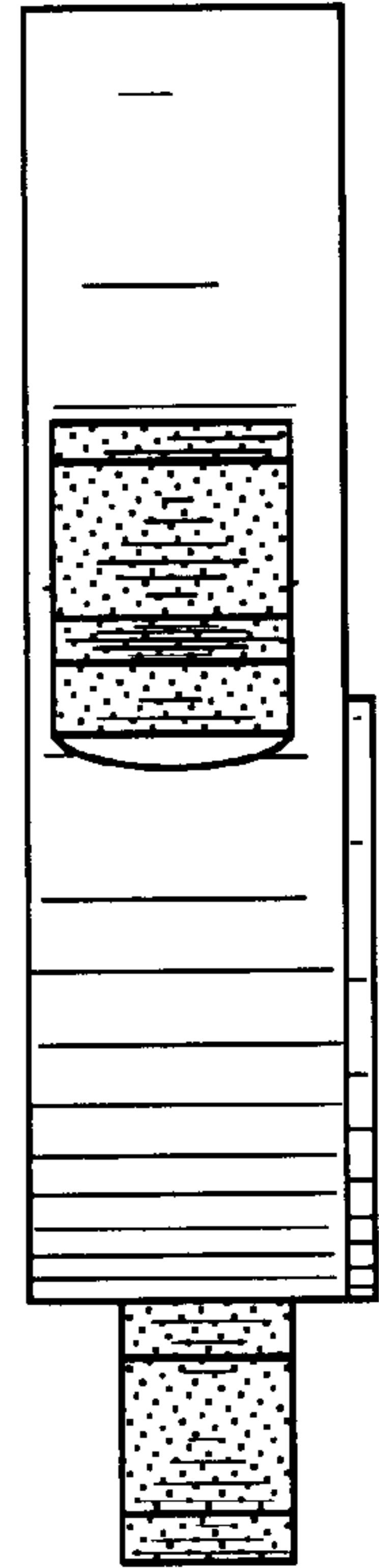

Fig. 5

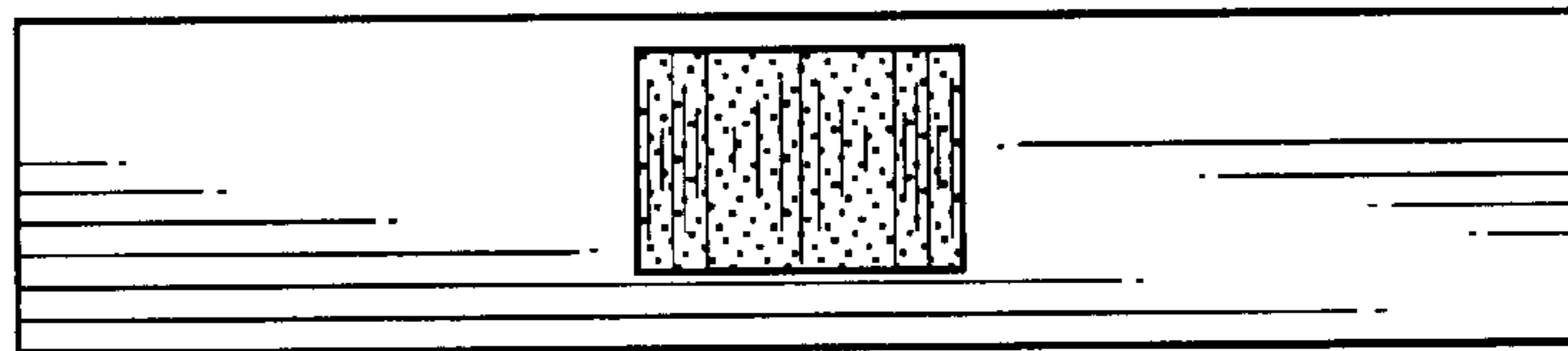

Fig. 6

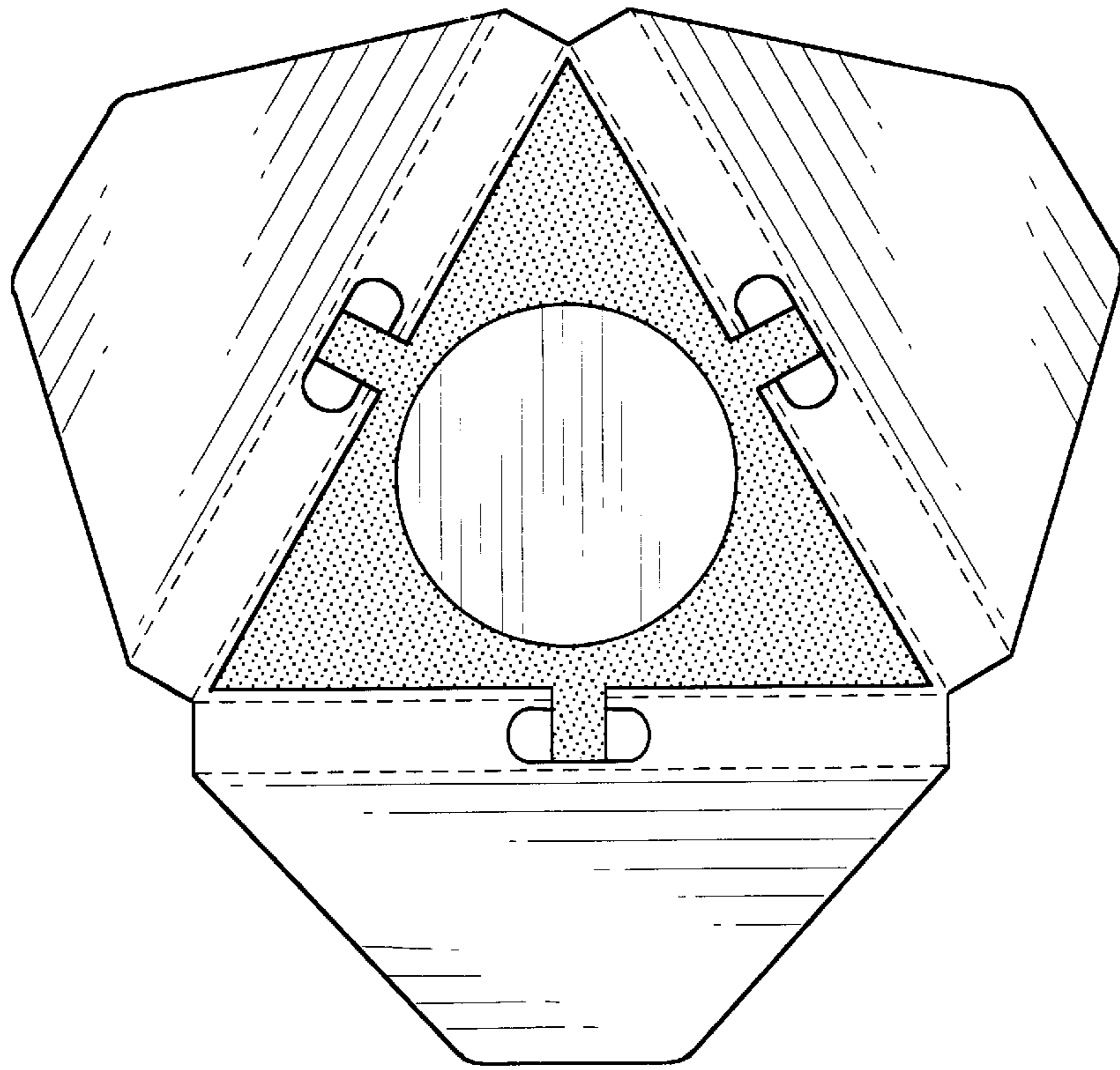

Fig. 7

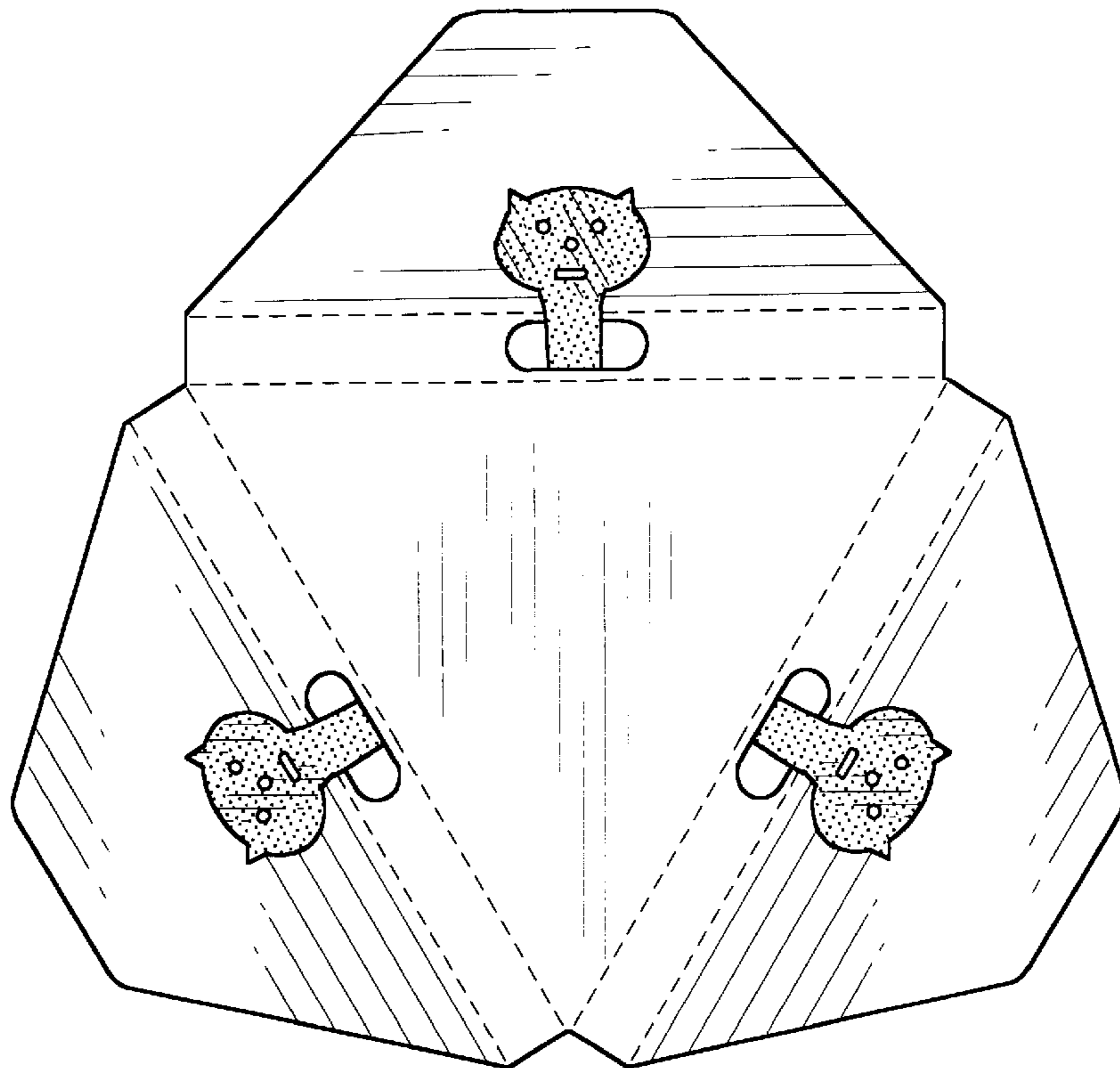

Fig. 8