



US00D424899S

# United States Patent [19] Jaime

[11] **Patent Number: Des. 424,899**

[45] **Date of Patent: \*\* May 16, 2000**

[54] **CUTTING TOOL**

D. 387,965 12/1997 Ronan ..... D8/14  
4,381,661 5/1983 Wiener et al. .... 81/418

[75] Inventor: **Ricardo Jaime**, Whittier, Calif.

[73] Assignee: **Alltrade Inc.**, Long Beach, Calif.

[\*\*] Term: **14 Years**

*Primary Examiner*—Joel Sincavage  
*Assistant Examiner*—Reid Hecker  
*Attorney, Agent, or Firm*—Robert R. Thornton

[21] Appl. No.: **29/107,505**

[22] Filed: **Jul. 7, 1999**

[57] **CLAIM**

The ornamental design for a cutting tool, as shown.

[51] **LOC (7) Cl.** ..... **08-05**

[52] **U.S. Cl.** ..... **D8/52**

[58] **Field of Search** ..... D8/51, 52, 4, 5,  
D8/14; 81/415, 417, 418; 30/130, 173,  
175, 192, 193, 250, 254

**DESCRIPTION**

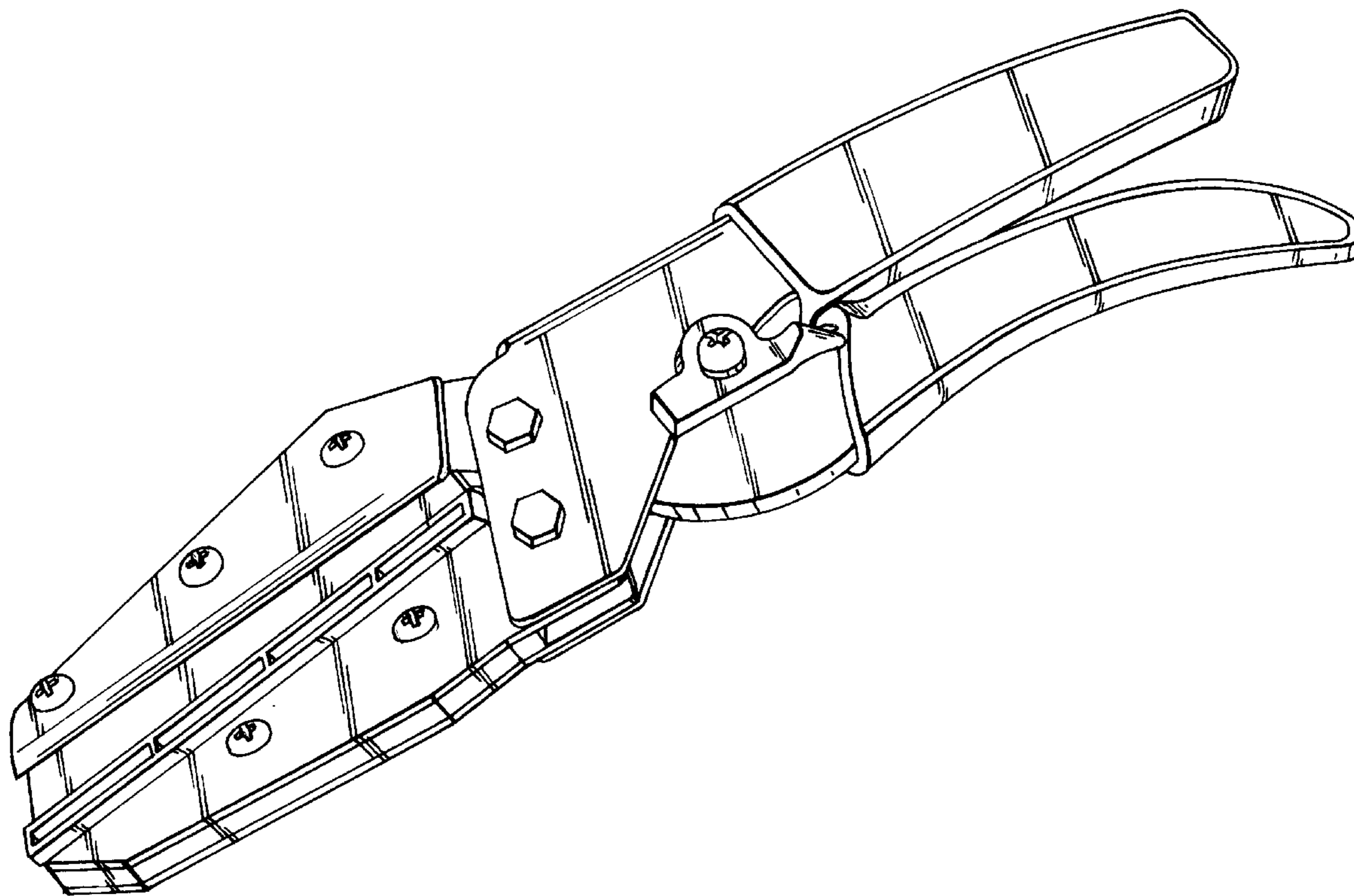
FIG. 1 is a perspective view of a cutting tool showing my new design;  
FIG. 2 is a left side elevational view thereof;  
FIG. 3 is a top plan view thereof;  
FIG. 4 is a bottom plan view thereof;  
FIG. 5 is a front elevational view thereof; and,  
FIG. 6 is a rear elevational view thereof.

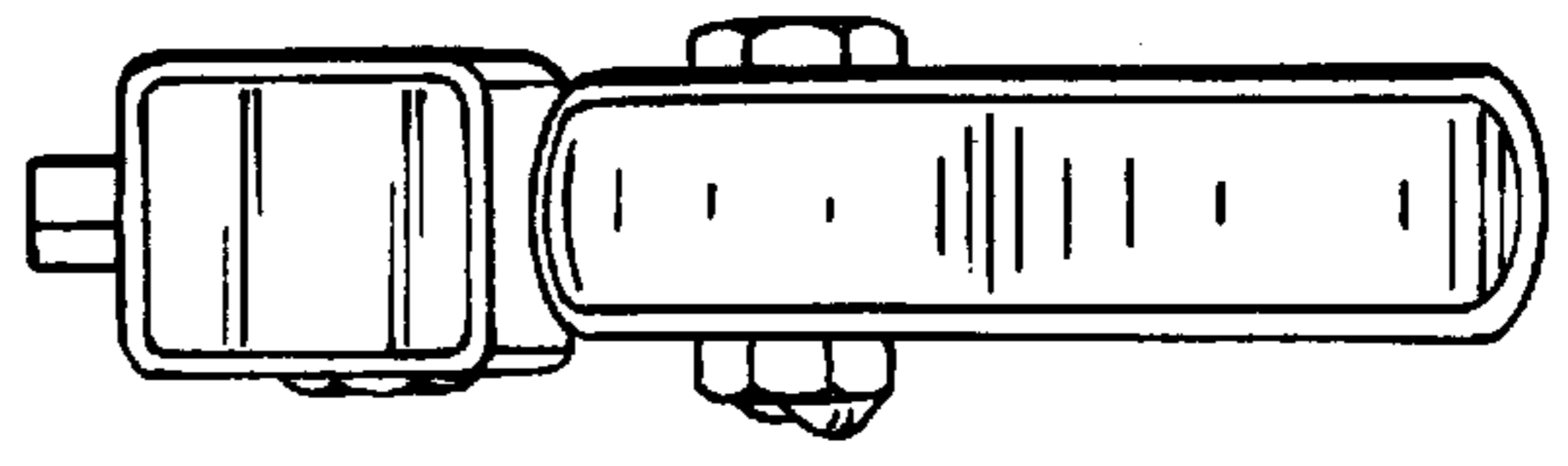
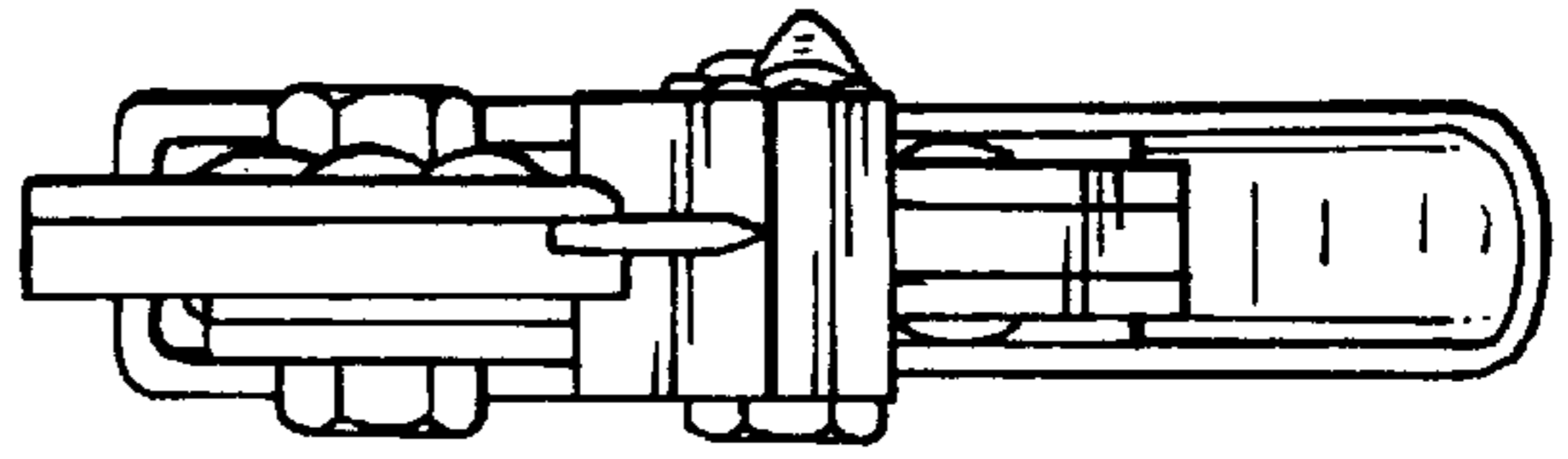
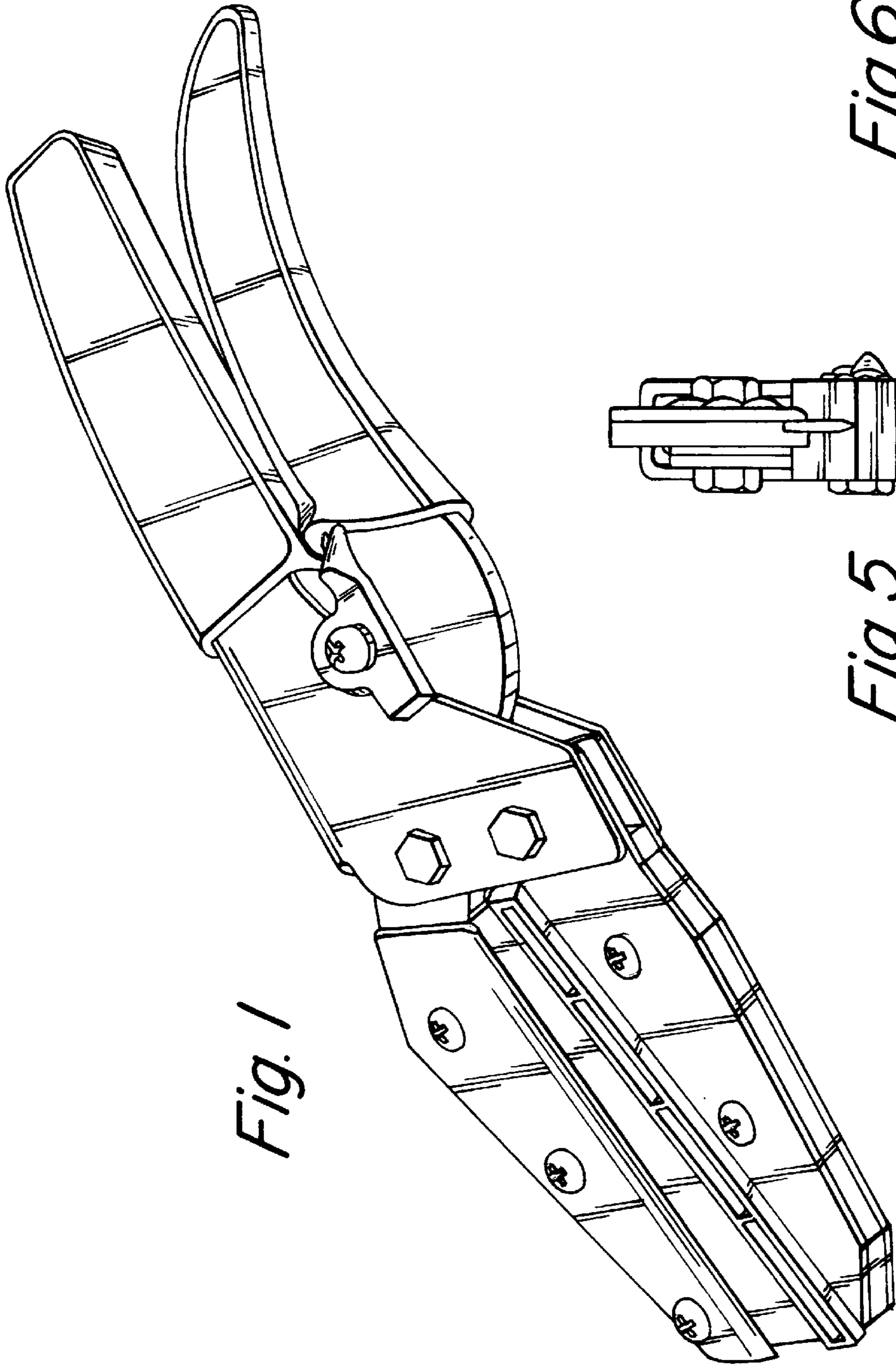
[56] **References Cited**

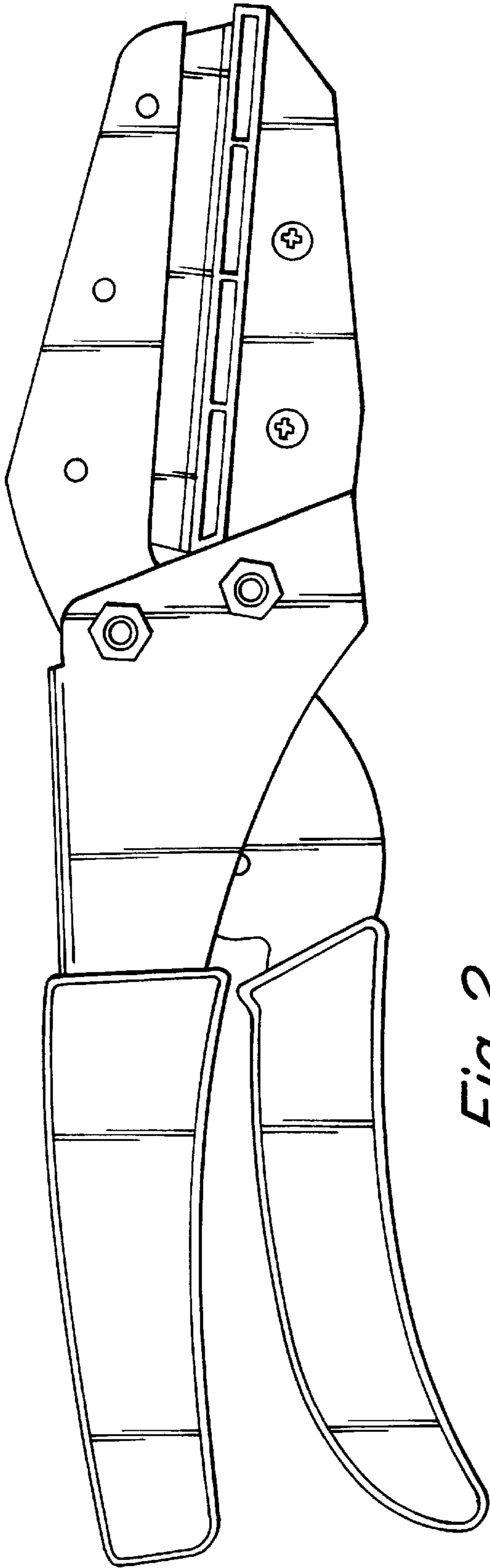
**U.S. PATENT DOCUMENTS**

D. 341,527 11/1993 Clivio ..... D8/5

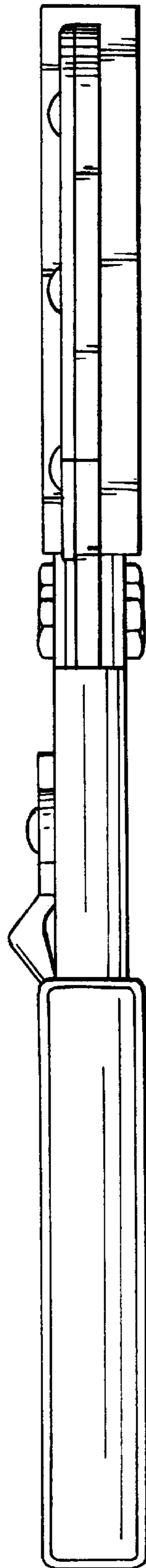
**1 Claim, 2 Drawing Sheets**



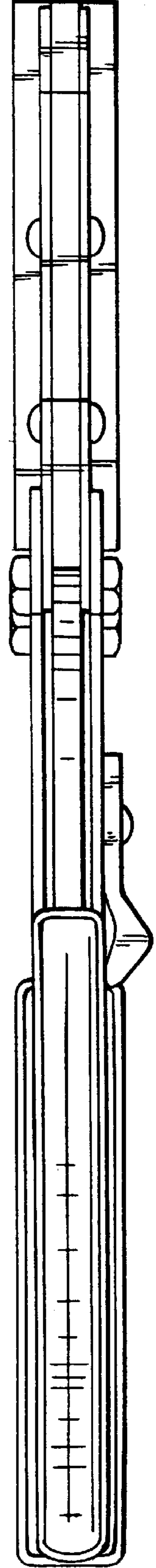




*Fig. 2*



*Fig. 3*



*Fig. 4*