



US00D424875S

United States Patent [19]
Husted

[11] **Patent Number: Des. 424,875**

[45] **Date of Patent: ** May 16, 2000**

[54] **ROUND ACRYLIC DRINKING VESSEL WITH METALLIC INSERT AND LID**

[76] Inventor: **Wayne D. Husted**, 73 California Ave., Mill Valley, Calif. 94911

[**] Term: **14 Years**

[21] Appl. No.: **29/098,262**

[22] Filed: **Dec. 24, 1998**

[51] **LOC (7) Cl.** **07-01**

[52] **U.S. Cl.** **D7/510; D7/511; D7/523**

[58] **Field of Search** D7/507, 507.513, D7/510, 511, 608, 619, 622, 629, 523, 533, 534, 514, 515, 625, 512, 532, 300.1; 220/669, 737, 673, 675, 672, 715; 215/222

[56] **References Cited**

U.S. PATENT DOCUMENTS

D. 219,898	2/1971	Buckley	D7/300.1
D. 283,596	4/1986	Fortuna et al.	D7/510 X
D. 365,247	12/1995	Sokolski et al.	D7/511
D. 377,293	1/1997	Husted	D7/510
D. 387,619	12/1997	Gross et al.	D7/510
D. 399,392	10/1998	Husted	D7/511

2,276,678	3/1942	Wheeler	215/227
2,754,866	7/1956	Coltman, Jr.	D7/300.1 X
2,765,639	10/1956	Bryant	D7/510 X
3,677,524	7/1972	Douglas	D7/300.1 X
4,852,757	8/1989	Gold	D7/510
4,974,741	12/1990	Gustafson et al.	D7/510 X

Primary Examiner—M. N. Pandozzi
Attorney, Agent, or Firm—Thomas V. Malorzo

[57] **CLAIM**

I claim the ornamental design for round acrylic drinking vessel with a metallic insert and lid, as shown.

DESCRIPTION

FIG. 1 is a perspective view of the round acrylic drinking vessel with metallic insert and lid.
FIG. 2 is a partially exploded side elevation view of the round acrylic drinking vessel with metallic insert and lid;
FIG. 3 is the bottom view of the round acrylic drinking vessel with metallic insert and lid.
FIG. 4 is the top view of the round acrylic drinking vessel with metallic insert and lid; and,
FIG. 5 is a cross sectional view taken through the line 5—5' of FIG. 1.

1 Claim, 1 Drawing Sheet

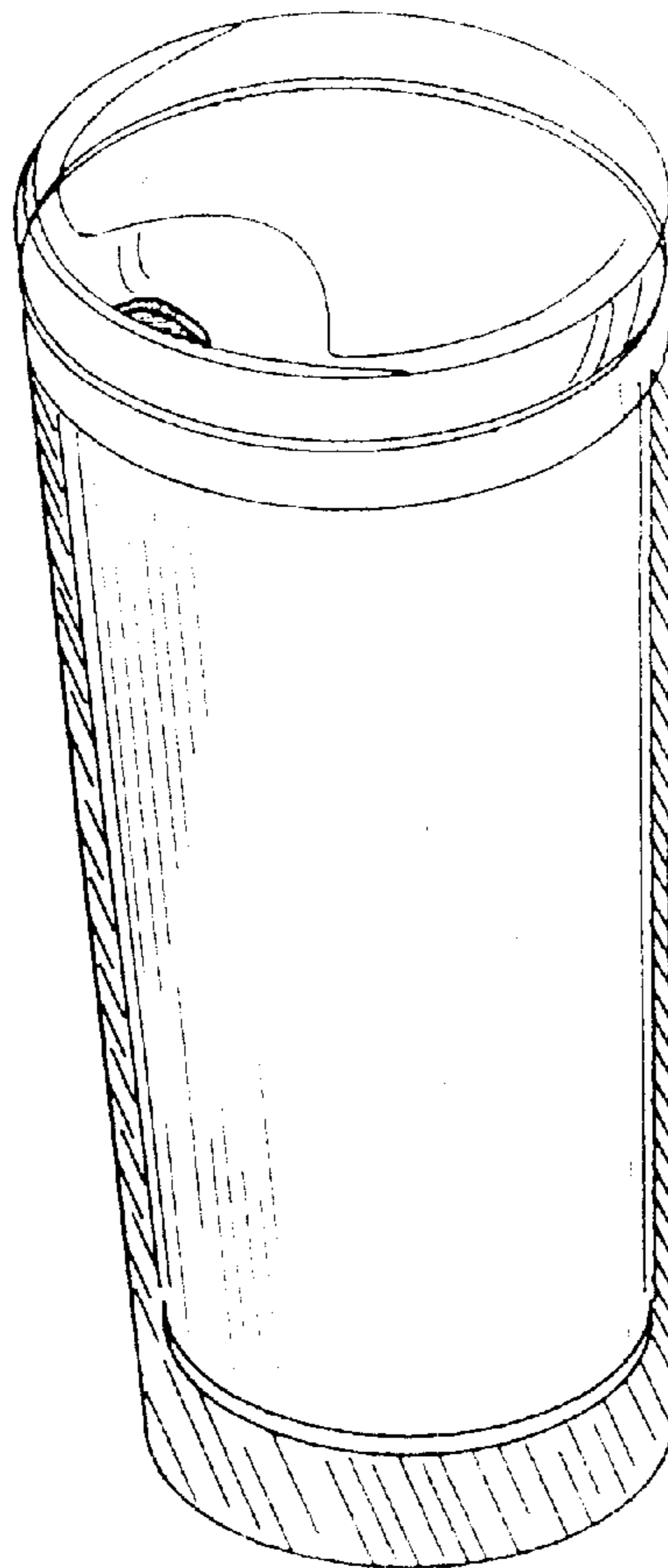

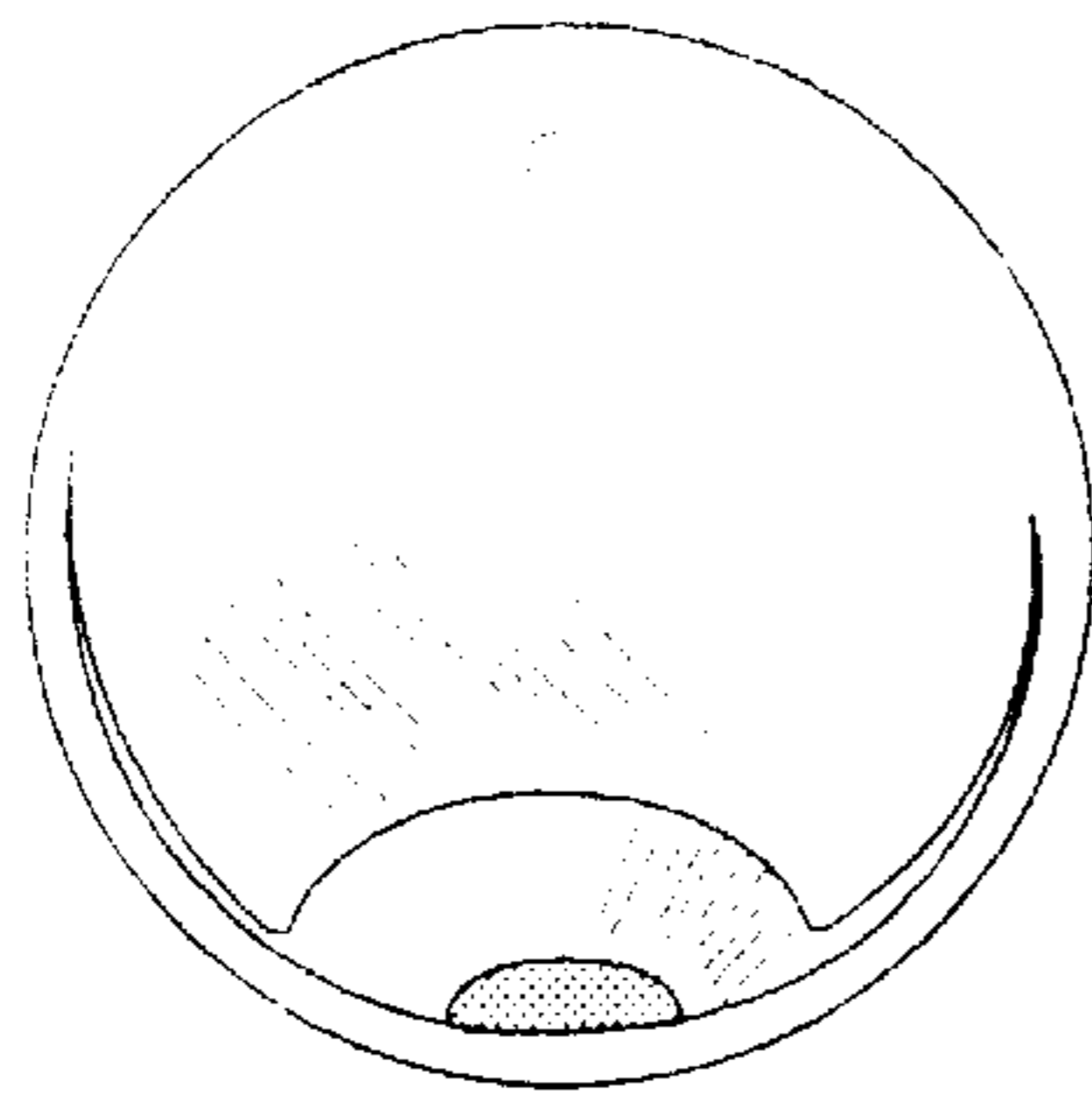

FIG 4

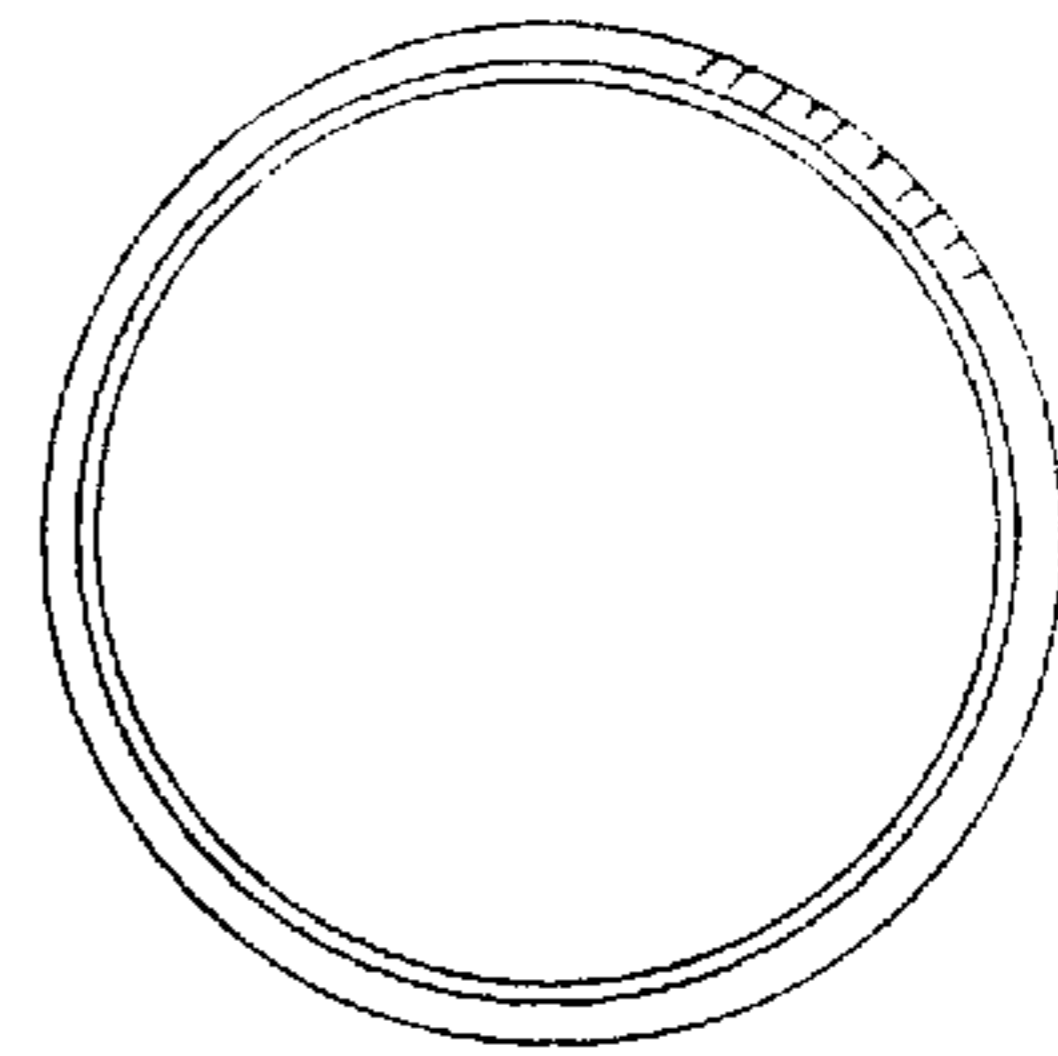
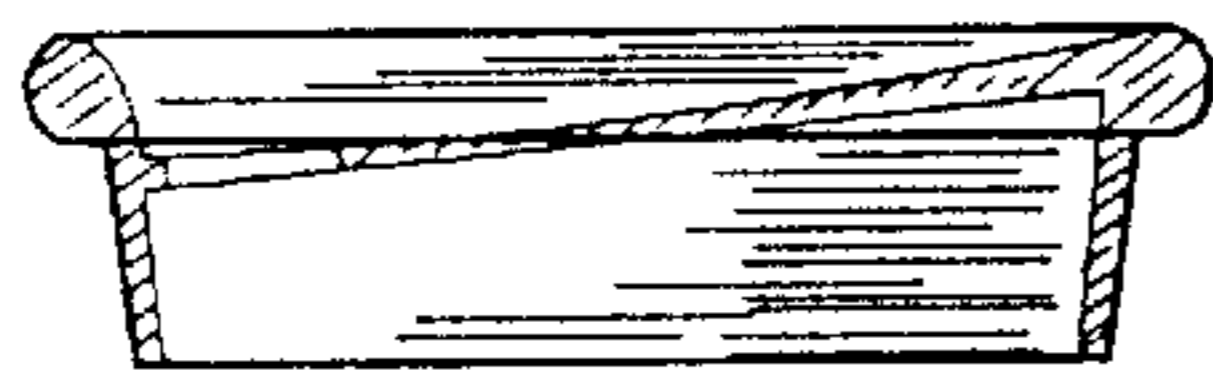

FIG 5

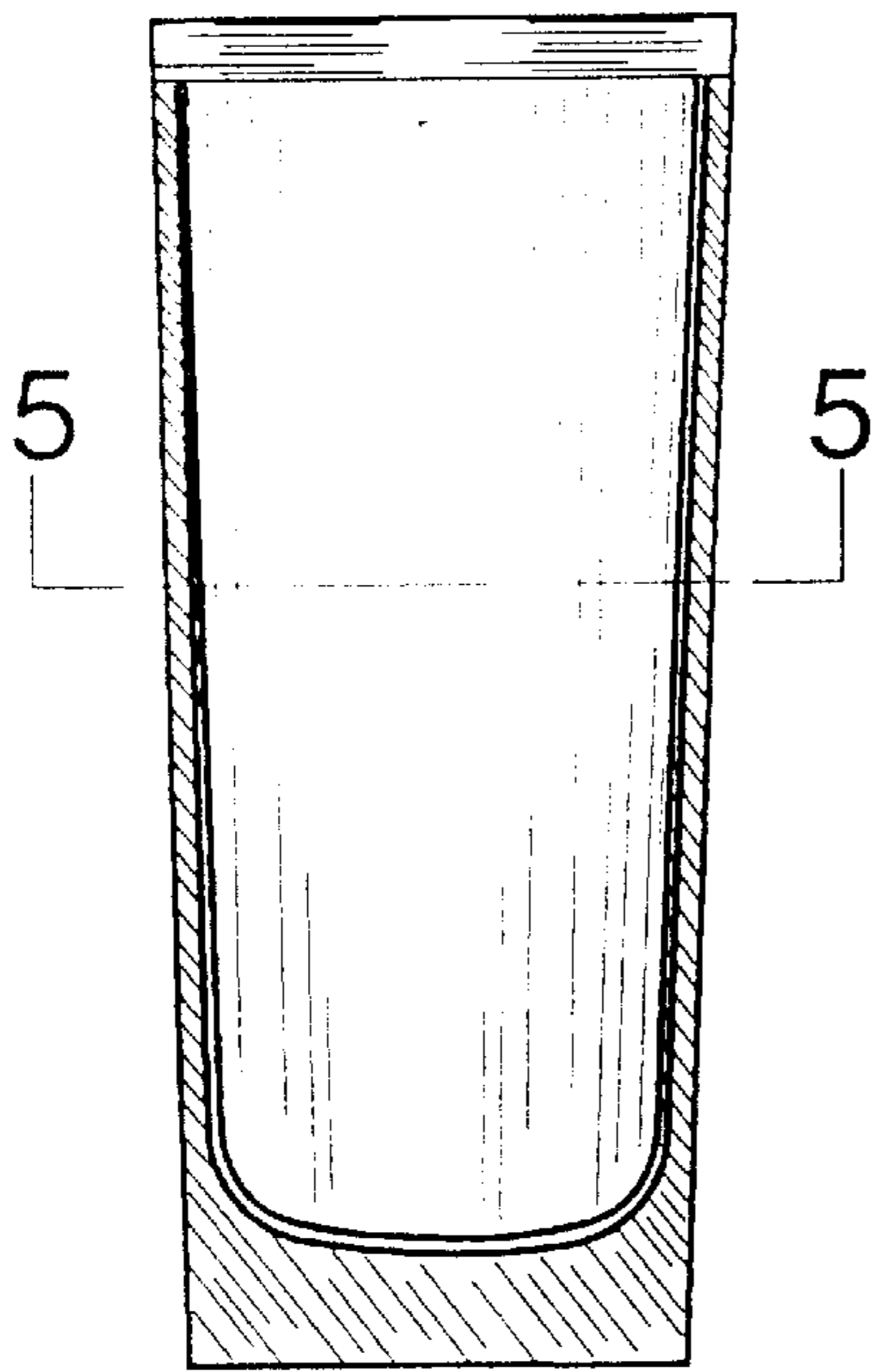

FIG 2

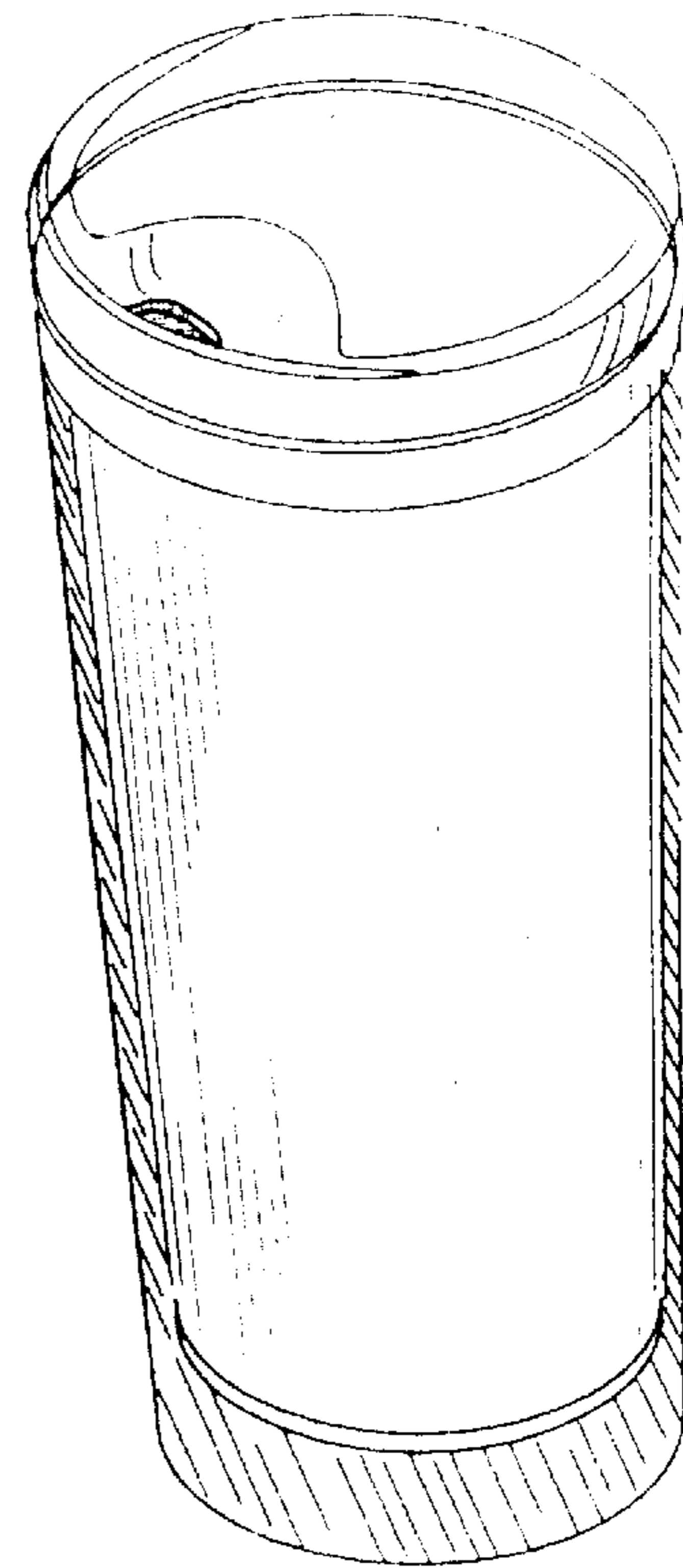

FIG 1

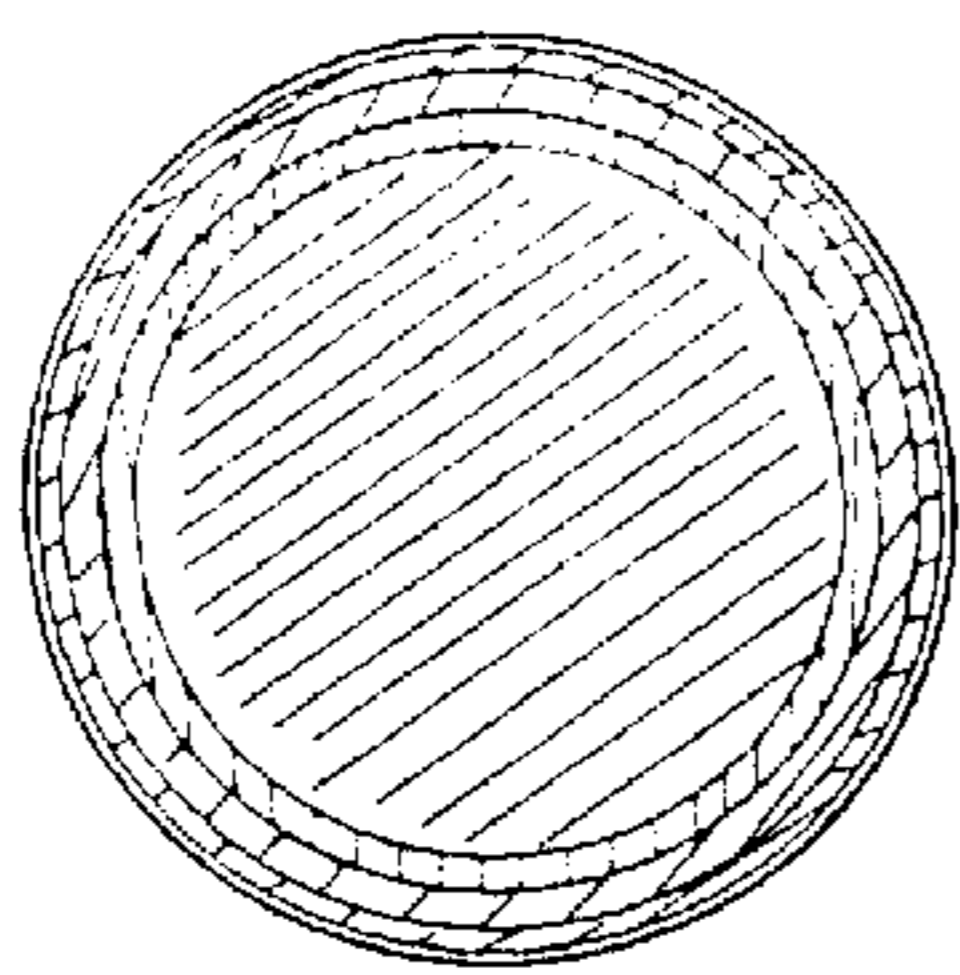

FIG 3

UNITED STATES PATENT AND TRADEMARK OFFICE
CERTIFICATE OF CORRECTION

PATENT NO. : Des 424,875
DATED : May 16, 2000
INVENTOR(S) : Husted

Page 1 of 3

It is certified that error appears in the above-identified patent and that said Letters Patent is hereby corrected as shown below:

Please delete print Fig. 1 as shown on title page and substitute therefor the attached title page.

Please substitute the attached drawings to replace original drawings.

Signed and Sealed this

Thirty first Day of July, 2001

Attest:

Nicholas P. Godici

Attesting Officer

NICHOLAS P. GODICI
Acting Director of the United States Patent and Trademark Office

United States Patent [19]
Husted

(11) **Patent Number: Des. 424,875**
(45) **Date of Patent: ** May 16, 2000**

[54] **ROUND ACRYLIC DRINKING VESSEL WITH METALLIC INSERT AND LID**
[76] **Inventor: Wayne D. Husted, 73 California Ave., Mill Valley, Calif. 94911**

2,276,678 3/1942 Wheeler 215/227
2,754,866 7/1956 Coltman, Jr. D7/300.1 X
2,765,639 10/1956 Bryant D7/510 X
3,677,524 7/1972 Douglas D7/300.1 X
4,852,757 8/1989 Gold D7/510
4,974,741 12/1990 Gustafson et al. D7/510 X

[**] **Term: 14 Years**

Primary Examiner—M. N. Pandozzi
Attorney, Agent, or Firm—Thomas V. Malorzo

[21] **Appl. No.: 29/098,262**

[57] **CLAIM**

[22] **Filed: Dec. 24, 1998**

I claim the ornamental design for round acrylic drinking vessel with a metallic insert and lid, as shown.

[51] **LOC (7) Cl. 07-01**

[52] **U.S. Cl. D7/510; D7/511; D7/523**

[58] **Field of Search D7/507, 507.513, D7/510, 511, 608, 619, 622, 629, 523, 533, 534, 514, 515, 625, 512, 532, 300.1; 220/669, 737, 673, 675, 672, 715; 215/222**

DESCRIPTION

FIG. 1 is a perspective view of the round acrylic drinking vessel with metallic insert and lid.
FIG. 2 is a partially exploded side elevation view of the round acrylic drinking vessel with metallic insert and lid;
FIG. 3 is the bottom view of the round acrylic drinking vessel with metallic insert and lid.
FIG. 4 is the top view of the round acrylic drinking vessel with metallic insert and lid; and,
FIG. 5 is a cross sectional view taken through the line 5—5' of FIG. 1.

[56] **References Cited**

U.S. PATENT DOCUMENTS

D. 219,898 2/1971 Buckley D7/300.1
D. 283,596 4/1986 Fortuna et al. D7/510 X
D. 365,247 12/1995 Sokolski et al. D7/511
D. 377,293 1/1997 Husted D7/510
D. 387,619 12/1997 Gross et al. D7/510
D. 399,392 10/1998 Husted D7/511

1 Claim, 1 Drawing Sheet

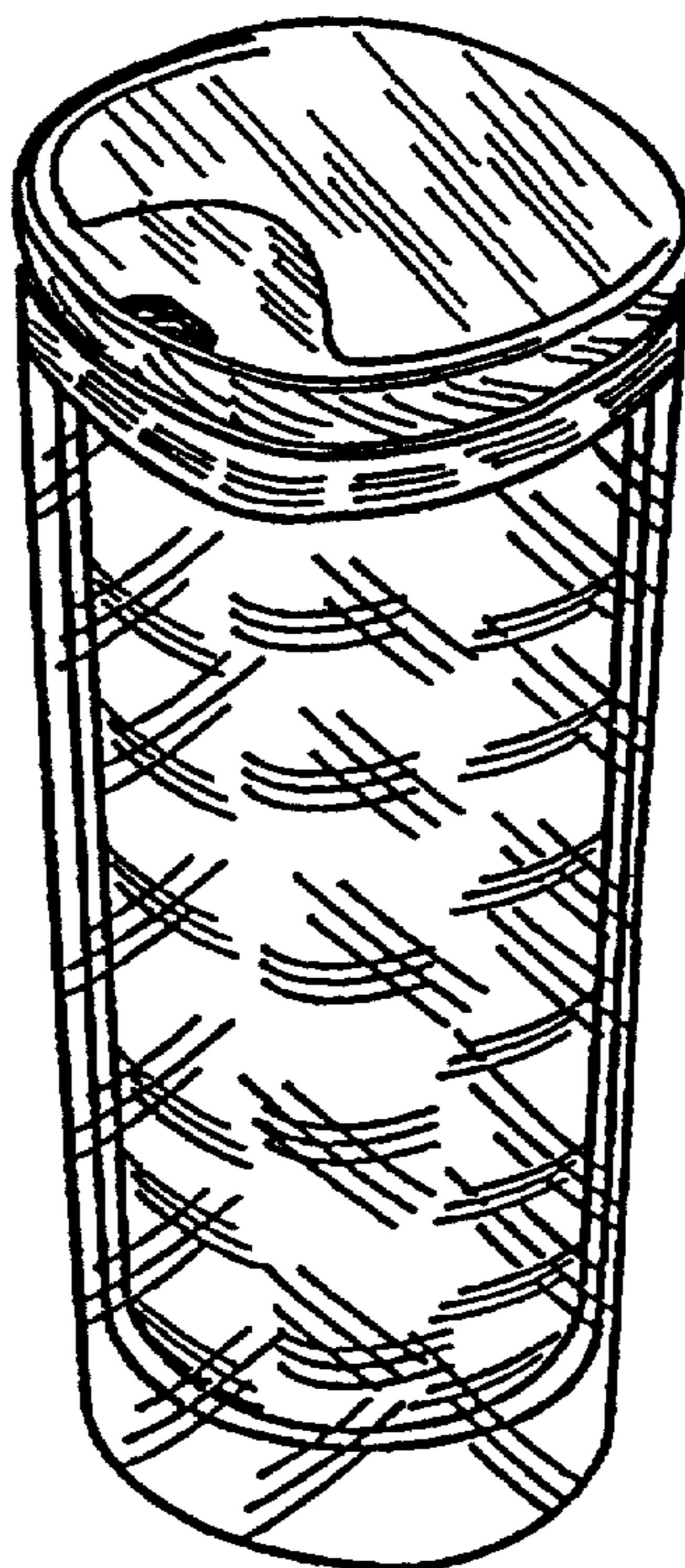

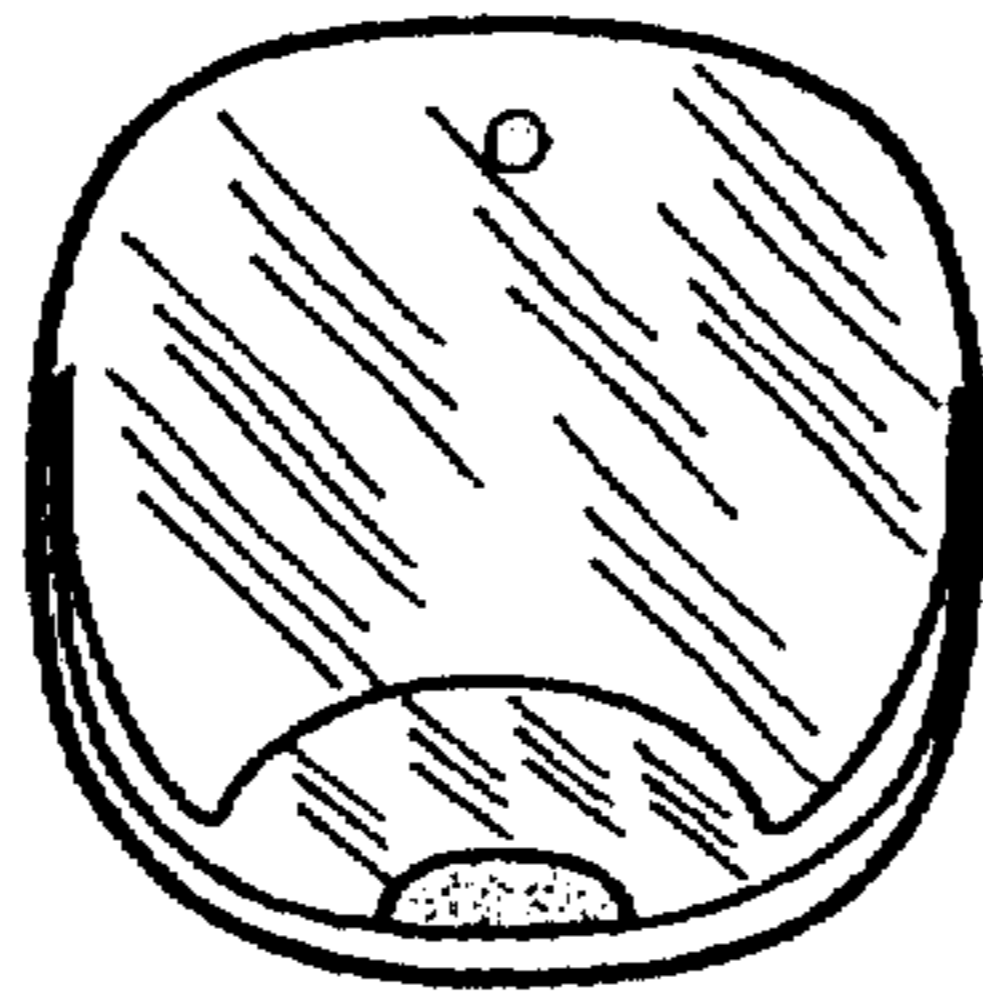

FIG 4

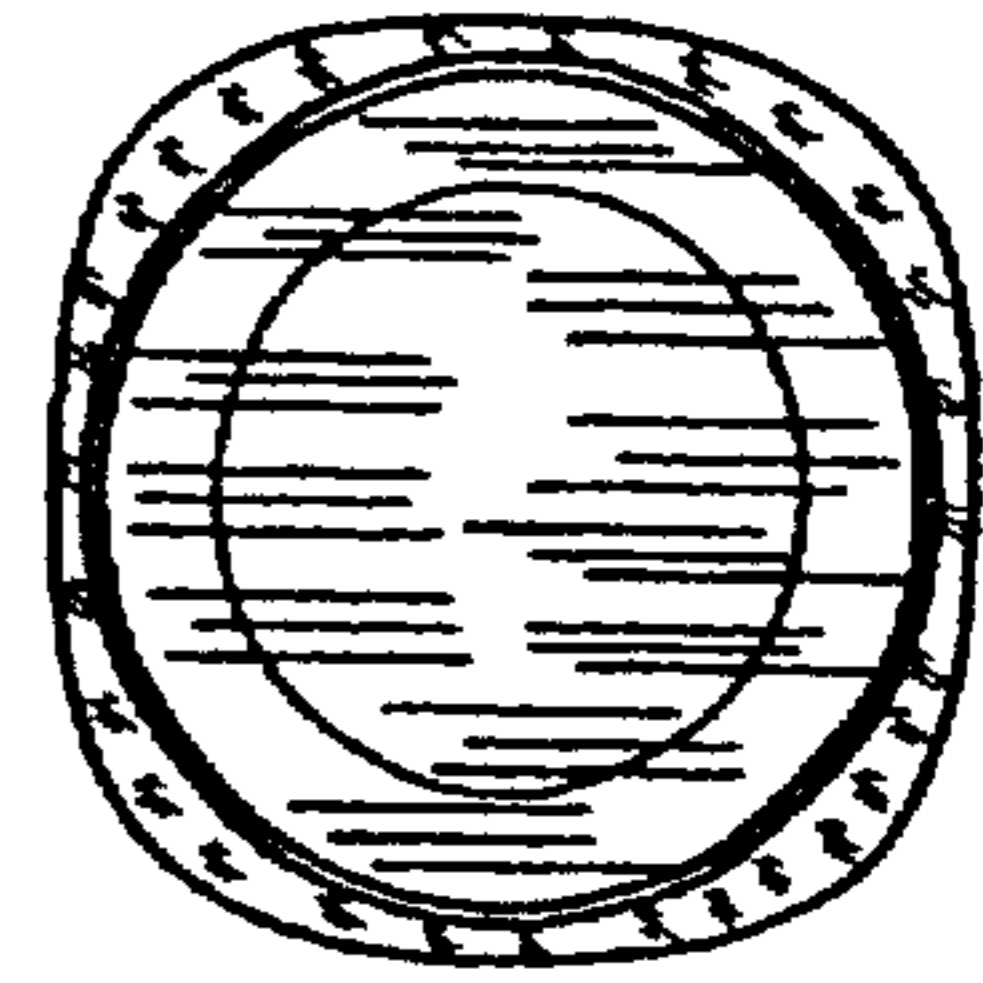

FIG 5

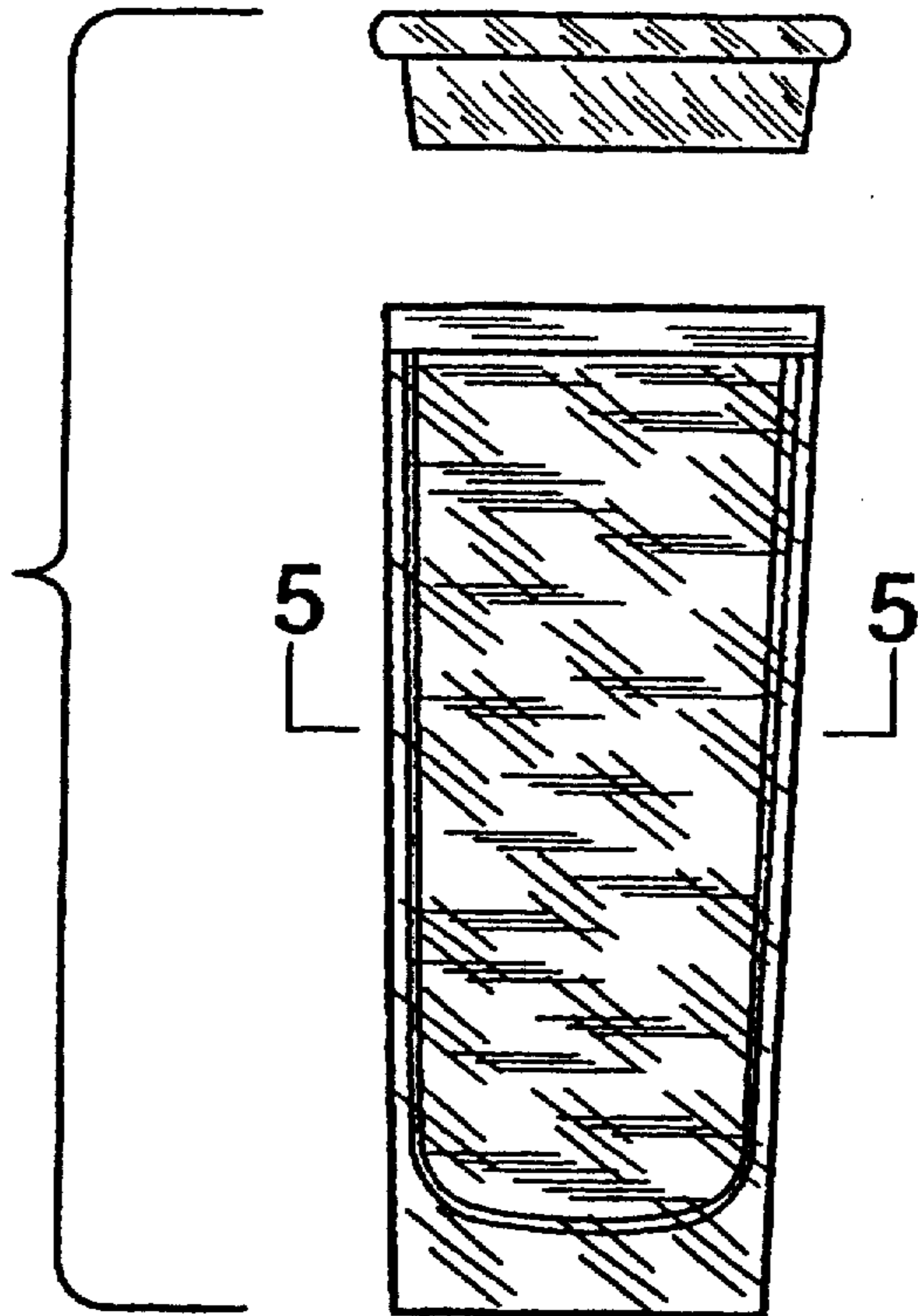

FIG 2

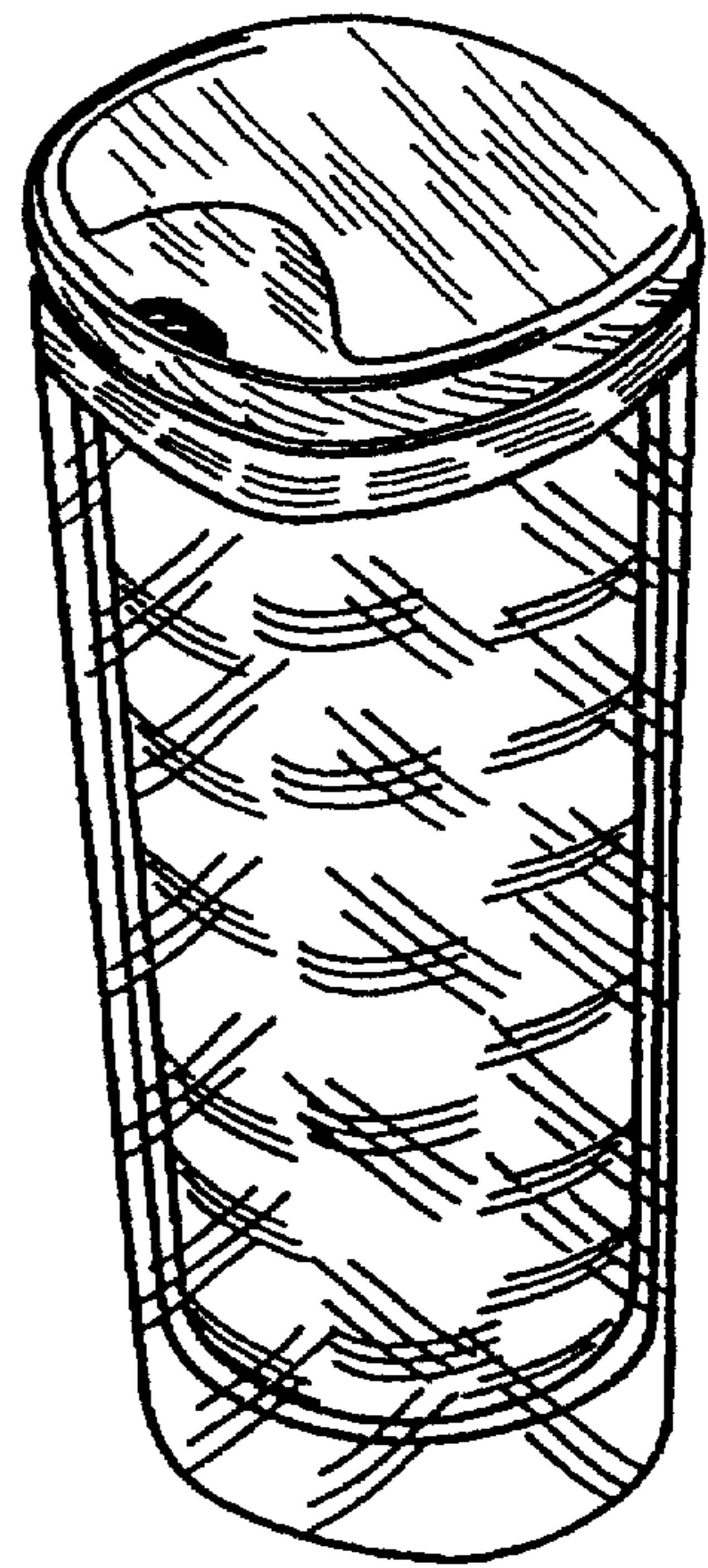

FIG 1

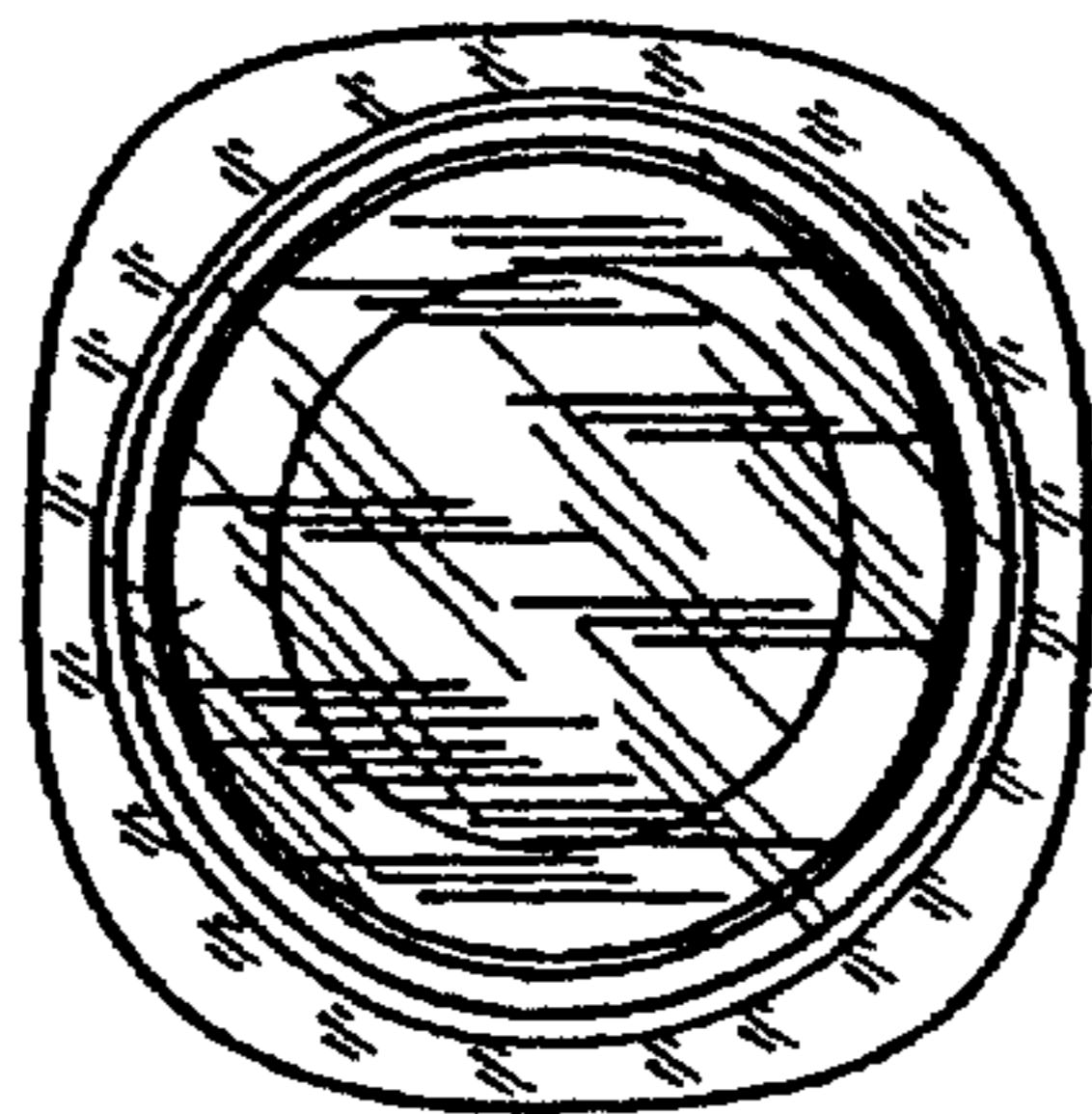

FIG 3

UNITED STATES PATENT AND TRADEMARK OFFICE
CERTIFICATE OF CORRECTION

PATENT NO. : Des. 424,875
DATED : May 16, 2000
INVENTOR(S) : Husted

Page 1 of 3

It is certified that error appears in the above-identified patent and that said Letters Patent is hereby corrected as shown below:

Title page,

Please delete print Fig. 1 as shown on title page and substitute therefor the attached title page.

Please substitute the attached drawings to replace original drawings.

This certificate supersedes Certificate of Correction issued July 31, 2001.

Signed and Sealed this

Seventeenth Day of December, 2002

A handwritten signature in black ink, appearing to read "James E. Rogan", written over a horizontal line.

JAMES E. ROGAN
Director of the United States Patent and Trademark Office

United States Patent [19]
Husted

[11] **Patent Number: Des. 424,875**
[45] **Date of Patent: ** May 16, 2000**

[54] **ROUND ACRYLIC DRINKING VESSEL WITH METALLIC INSERT AND LID**
[76] Inventor: **Wayne D. Husted**, 73 California Ave., Mill Valley, Calif. 94911
[**] Term: **14 Years**

2,276,678 3/1942 Wheeler 215/227
2,754,866 7/1956 Coltman, Jr. D7/300.1 X
2,765,639 10/1956 Bryant D7/510 X
3,677,524 7/1972 Douglas D7/300.1 X
4,852,757 8/1989 Gold D7/510
4,974,741 12/1990 Gustafson et al. D7/510 X

[21] Appl. No.: **29/098,262**
[22] Filed: **Dec. 24, 1998**

Primary Examiner—M. N. Pandozzi
Attorney, Agent, or Firm—Thomas V. Malorzo

[51] **LOC (7) Cl.** **07-01**
[52] **U.S. Cl.** **D7/510; D7/511; D7/523**
[58] **Field of Search** **D7/507, 507.513, D7/510, 511, 608, 619, 622, 629, 523, 533, 534, 514, 515, 625, 512, 532, 300.1; 220/669, 737, 673, 675, 672, 715; 215/222**

[57] **CLAIM**
I claim the ornamental design for round acrylic drinking vessel with a metallic insert and lid, as shown.

[56] **References Cited**
U.S. PATENT DOCUMENTS
D. 219,898 2/1971 Buckley D7/300.1
D. 283,596 4/1986 Fortuna et al. D7/510 X
D. 365,247 12/1995 Sokolski et al. D7/511
D. 377,293 1/1997 Husted D7/510
D. 387,619 12/1997 Gross et al. D7/510
D. 399,392 10/1998 Husted D7/511

DESCRIPTION
FIG. 1 is a perspective view of the round acrylic drinking vessel with metallic insert and lid.
FIG. 2 is a partially exploded side elevation view of the round acrylic drinking vessel with metallic insert and lid;
FIG. 3 is the bottom view of the round acrylic drinking vessel with metallic insert and lid.
FIG. 4 is the top view of the round acrylic drinking vessel with metallic insert and lid; and,
FIG. 5 is a cross sectional view taken through the line 5—5' of FIG. 1.

1 Claim, 1 Drawing Sheet

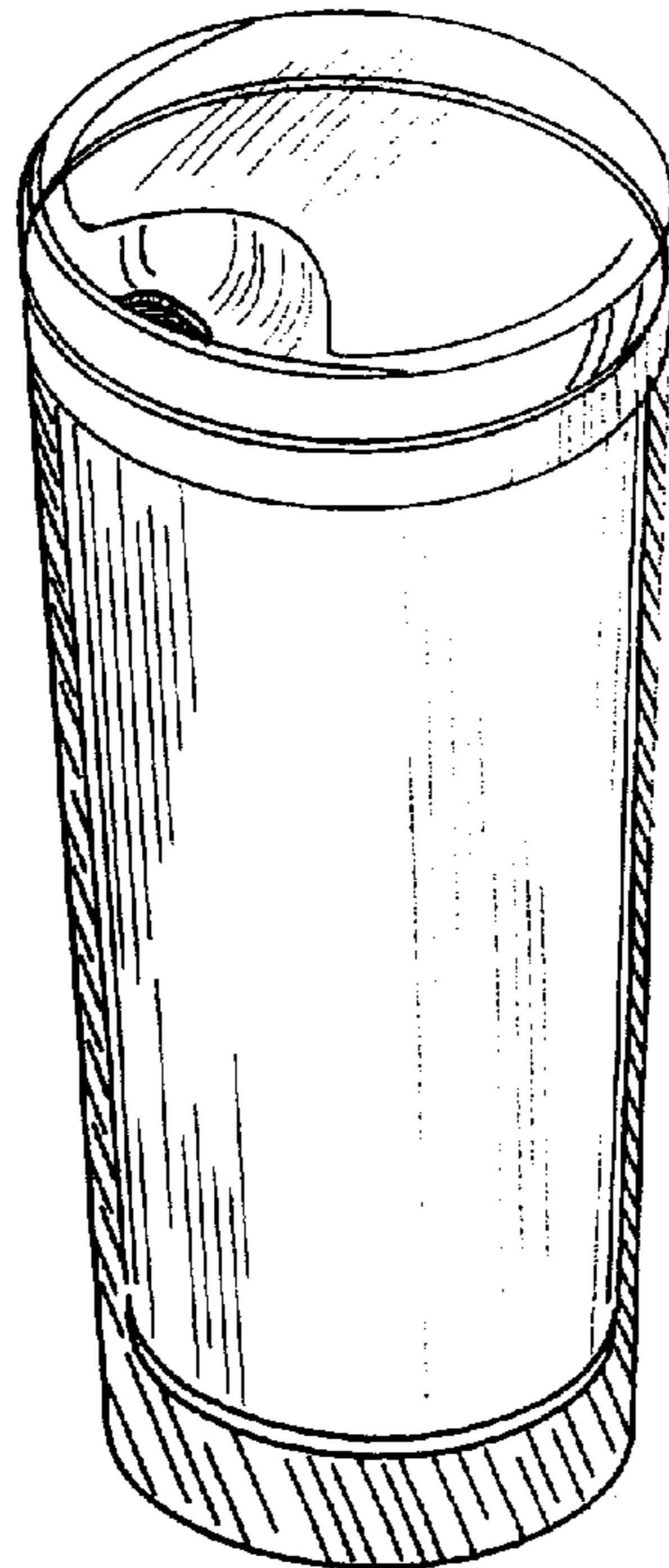

U.S. Patent

May 16, 2000

Des 424,875

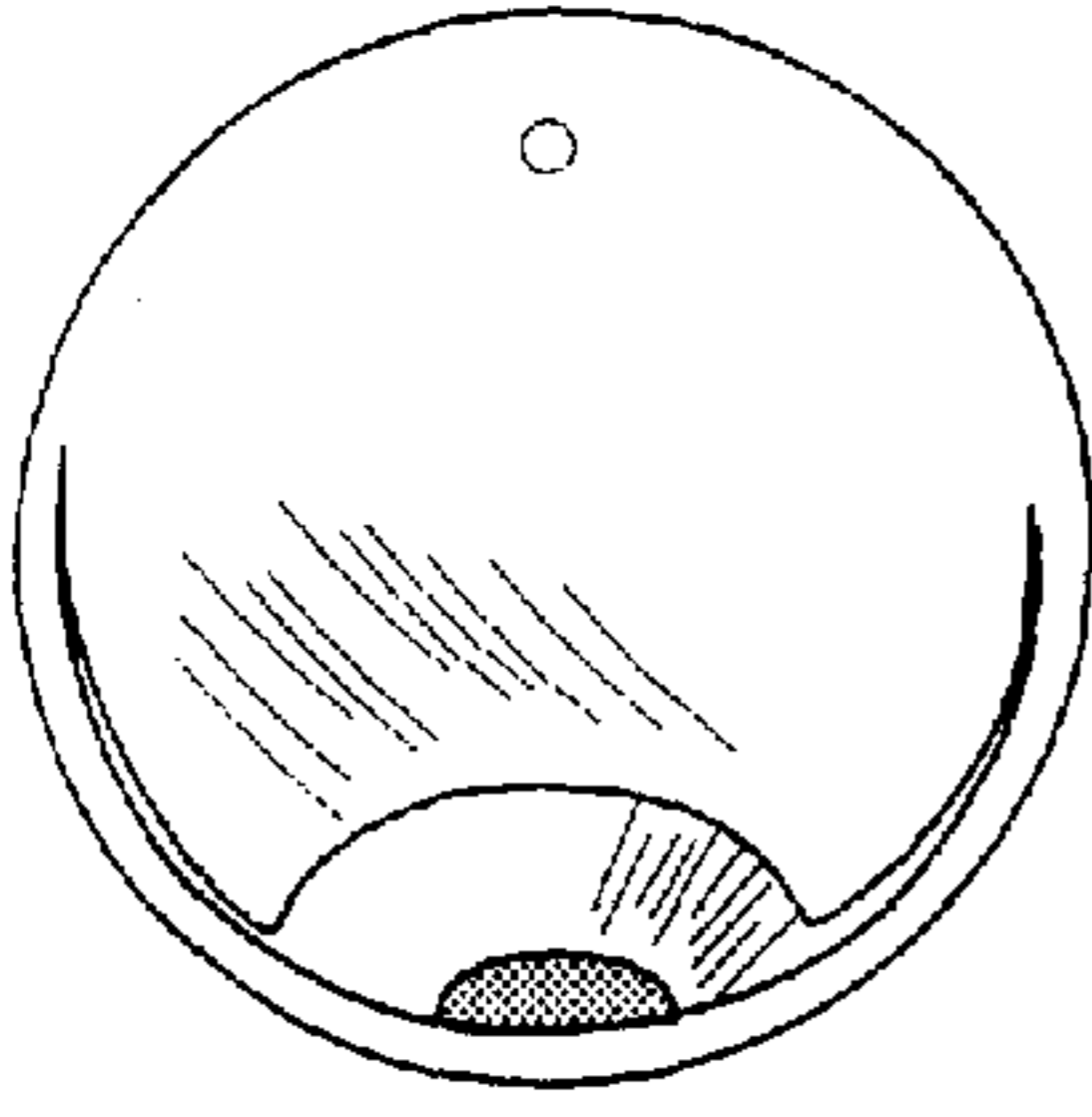

FIG 4

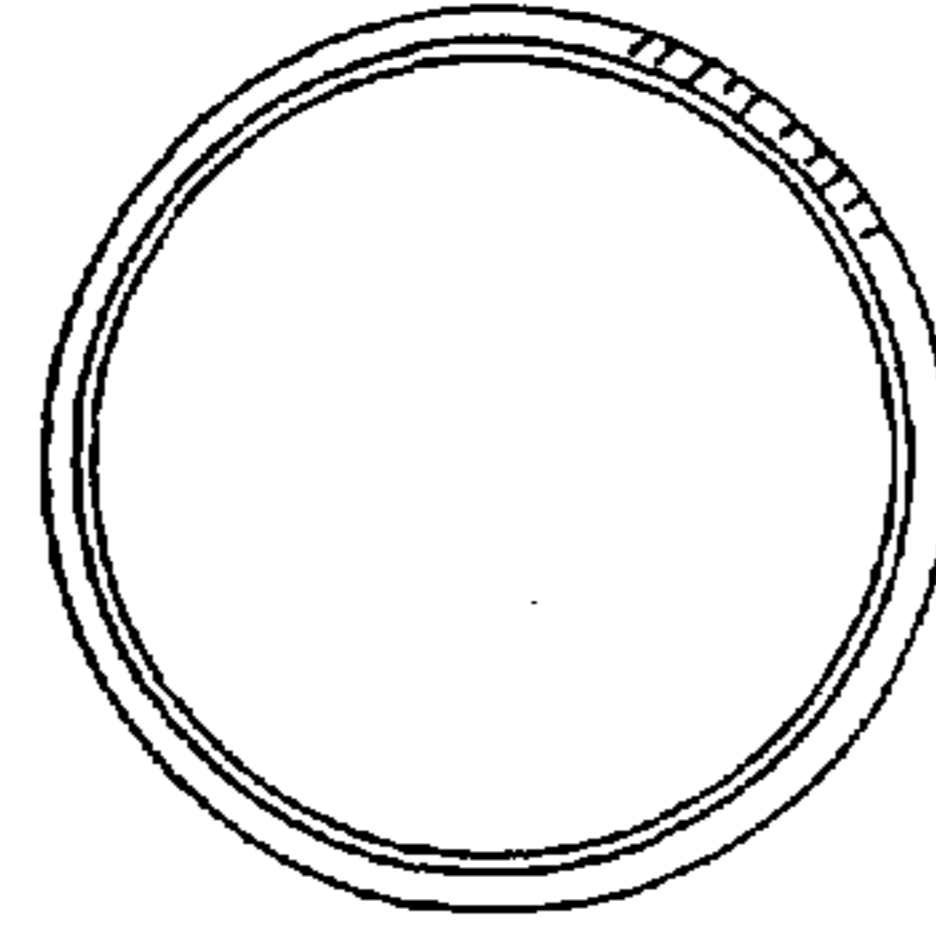
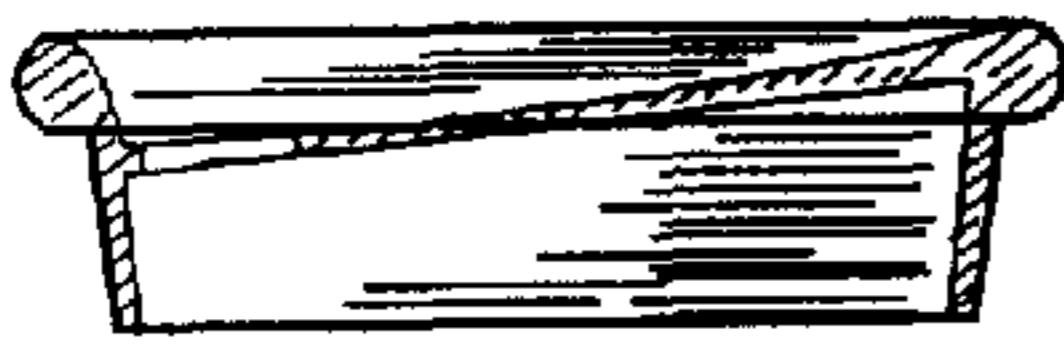

FIG 5

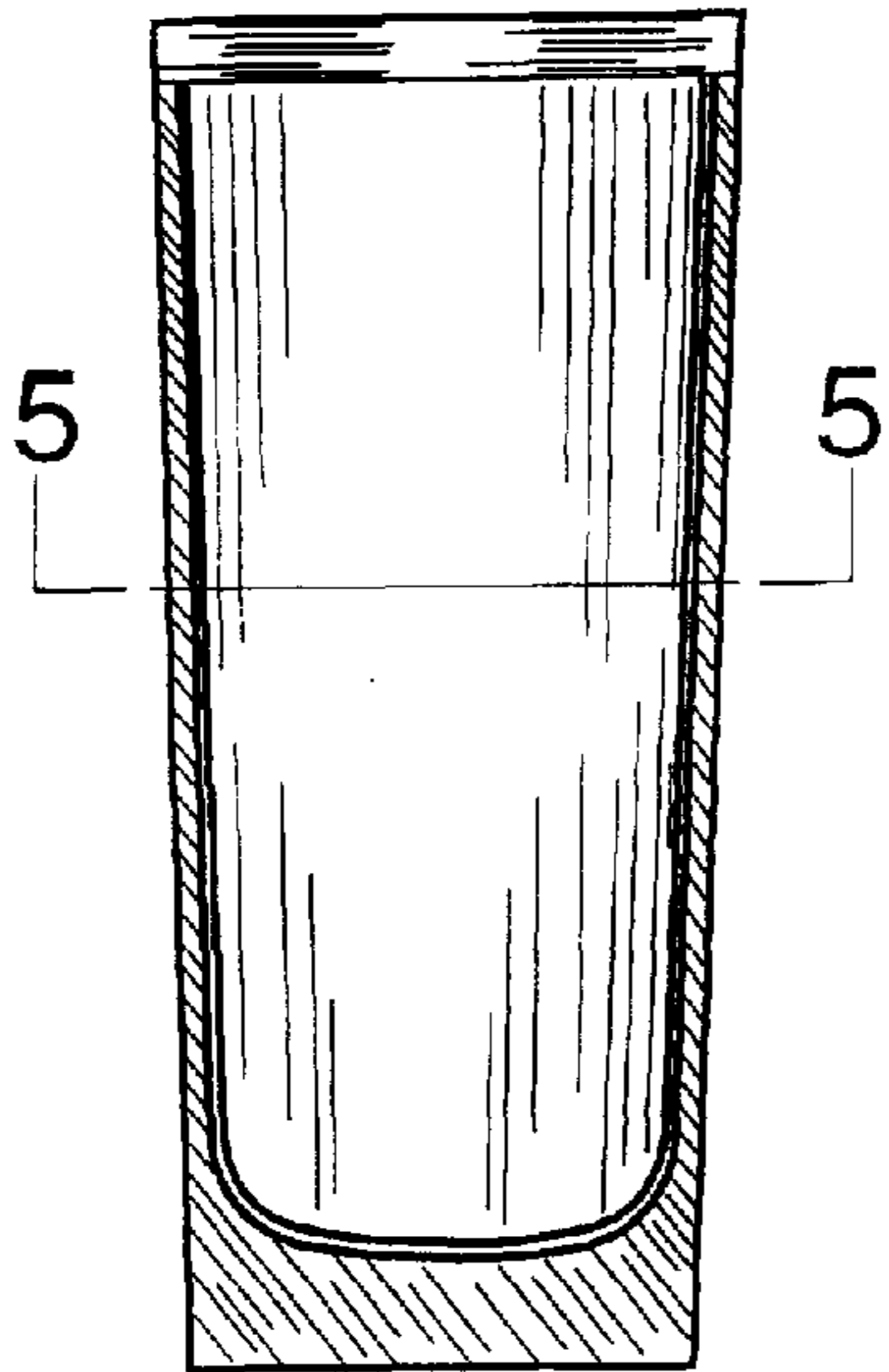

FIG 2

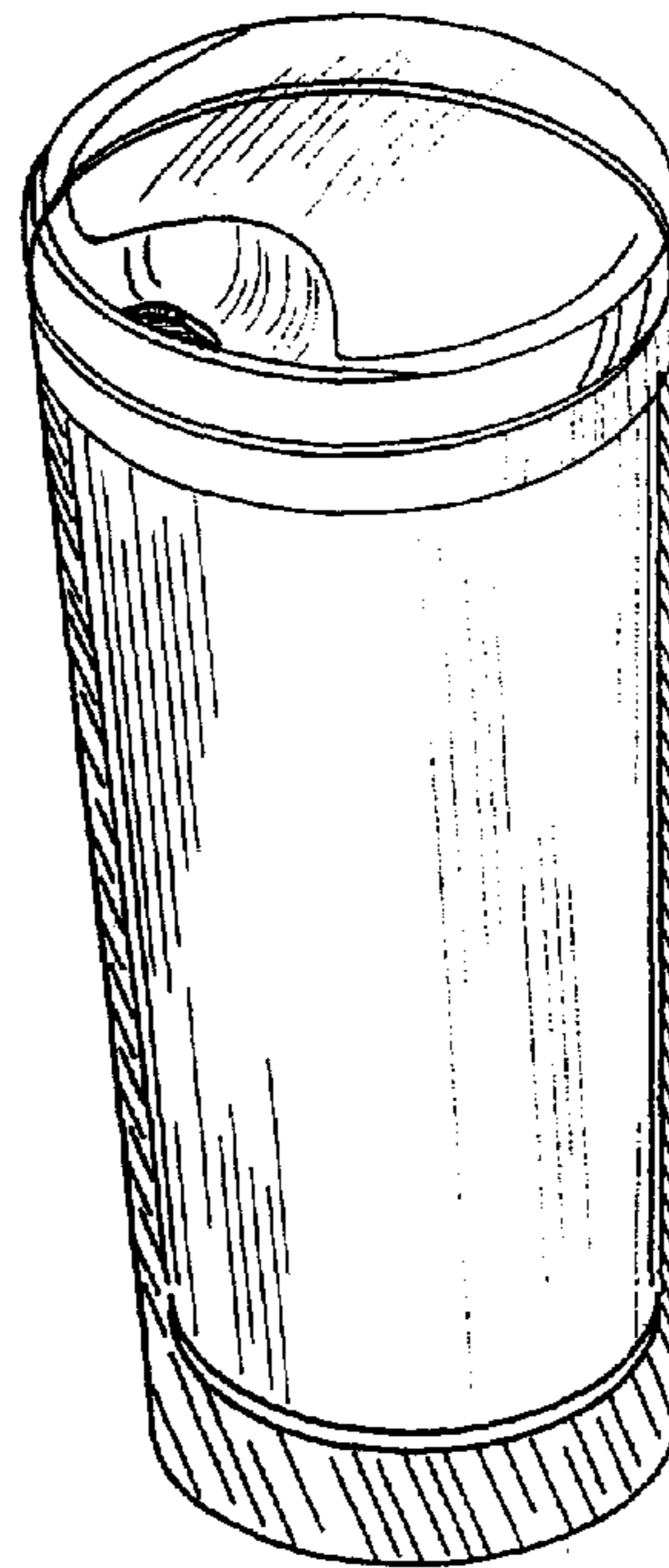

FIG 1

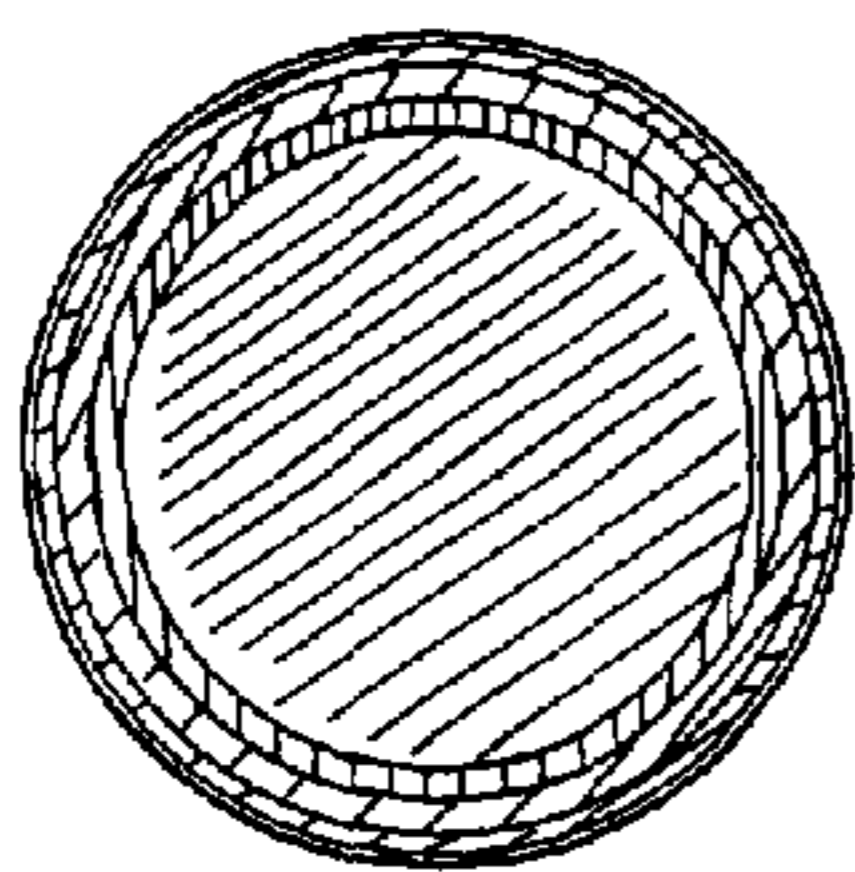

FIG 3