



US00D424826S

United States Patent [19]

Natuzzi et al.

[11] Patent Number: Des. 424,826

[45] Date of Patent: ** May 16, 2000

[54] SEAT

[75] Inventors: **Pasquale Natuzzi; Domenico Abbruzzese**, both of Bari, Italy

[73] Assignee: **Industrie Natuzzi SpA**, Bari, Italy

[**] Term: **14 Years**

[21] Appl. No.: **29/103,574**

[22] Filed: **Apr. 16, 1999**

[51] **LOC (7) Cl.** **06-01**

[52] **U.S. Cl.** **D6/381; D6/334**

[58] **Field of Search** D6/334, 335, 336, D6/364, 371, 373, 381, 500, 501, 502; 5/12.1; 297/232, 445.1, 446.1

[56] References Cited

U.S. PATENT DOCUMENTS

D. 246,143	10/1977	Nash	D6/381
D. 353,273	12/1994	Natuzzi et al.	D6/381
D. 368,377	4/1996	Laslo	D6/334
D. 373,911	9/1996	Paus	D6/381
D. 403,167	12/1998	Hutton	D6/334
D. 415,904	11/1999	Zaidman	D6/381

OTHER PUBLICATIONS

Natuzzi Model 459, Oct. 1988, at International Home Furnishings Market in High Point, North Carolina.
 Natuzzi Model 481, at least as early as 1989, at International Home Furnishings Market in High Point, North Carolina.
 Natuzzi Model 739, Apr. 1990, at International Home Furnishings Market in High Point, North Carolina.
 Natuzzi Model 749, Apr. 1990, at International Home Furnishings Market in High Point, North Carolina.
 Natuzzi Model 854, Apr. 1990, at International Home Furnishings Market in High Point, North Carolina.
 Natuzzi Model 880, at least as early as 1992, at International Home Furnishings Market in High Point, North Carolina.
 Natuzzi Model 943, Sep. 1992, at International Home Furnishings Market in High Point, North Carolina.

Natuzzi Model 979, Oct., 1992, at International Home Furnishings Market in High Point, North Carolina.
 Natuzzi Model 985, Oct. 1992, at International Home Furnishings Market in High Point, North Carolina.
 Natuzzi Model 987, Oct. 1992, at International Home Furnishings Market in High Point, North Carolina.
 Natuzzi Model 998, Oct. 1992, at International Home Furnishings Market in High Point, North Carolina.
 Natuzzi Model 1022, Mar. 1993, at International Home Furnishings Market in High Point, North Carolina.
 Natuzzi Model 1049, Apr. 1993, at International Home Furnishings Market in High Point, North Carolina.
 Natuzzi Model 1147, Apr. 1994, at International Home Furnishings Market in High Point, North Carolina.

(List continued on next page.)

Primary Examiner—Gary D. Watson
Attorney, Agent, or Firm—Alston & Bird LLP

[57] CLAIM

The ornamental design for a seat, as shown and described.

DESCRIPTION

FIG. 1 is a front perspective view of a seat showing our new design in the form of a sofa;
 FIG. 2 is a front elevational view thereof;
 FIG. 3 is a top plan view thereof;
 FIG. 4 is a right side elevational view, the left side being a mirror image thereof;
 FIG. 5 is a rear perspective view thereof;
 FIG. 6 is a front elevational view of a seat showing our new design in the form of a loveseat; and,
 FIG. 7 is a front elevational view of a seat showing our new design in the form of a chair.
 The broken lines shown herein are for illustrative purposes only and form no part of the claimed design.
 The rear views of FIGS. 6 and 7 are like FIG. 5, the difference being a matter of length.
 The end views of FIGS. 6 and 7 are like FIG. 4.
 FIG. 1 is shown on an enlarged scale with respect to the other views.

1 Claim, 3 Drawing Sheets

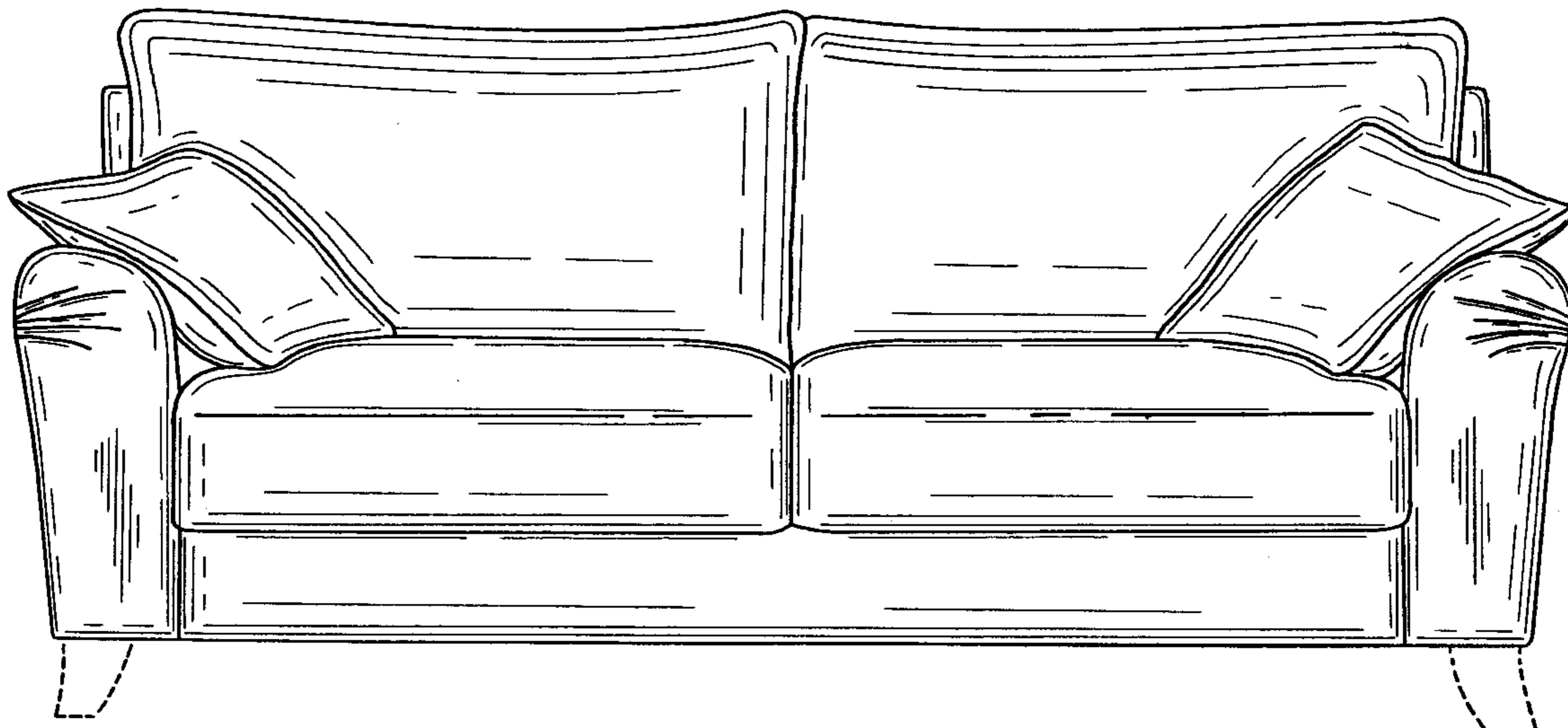

OTHER PUBLICATIONS

Natuzzi Model 1164, at least as early as 1994, at International Home Furnishings Market in High Point, North Carolina.

Natuzzi Model 1180, Apr. 1994, at International Home Furnishings Market in High Point, North Carolina.

Natuzzi Model 1196, Oct. 1994, at International Home Furnishings Market in High Point, North Carolina.

Natuzzi Model 1203, Oct. 1994, at International Home Furnishings Market in High Point, North Carolina.

Natuzzi Model 1215, Oct. 1994, at International Home Furnishings Market in High Point, North Carolina.

Natuzzi Model 1223, Oct. 1994, at International Home Furnishings Market in High Point, North Carolina.

Natuzzi Model 1224, Oct. 1994, at International Home Furnishings Market in High Point, North Carolina.

Natuzzi Model 1225, Oct. 1994, at International Home Furnishings Market in High Point, North Carolina.

Natuzzi Model 1268, Mar. 1995, at International Home Furnishings Market in High Point, North Carolina.

Natuzzi Model 1319, Apr. 1995, at International Home Furnishings Market in High Point, North Carolina.

Natuzzi Model 1331, Sep. 1995, at International Home Furnishings Market in High Point, North Carolina.

Natuzzi Model 1414, Mar. 1996, at International Home Furnishings Market in High Point, North Carolina.

Natuzzi Model 1463, Apr. 1996, at International Home Furnishings Market in High Point, North Carolina.

Natuzzi Model 1499, at least as early as 1996, at International Home Furnishings Market in High Point, North Carolina.

Natuzzi Model 1502, Oct. 1996, at International Home Furnishings Market in High Point, North Carolina.

Natuzzi Model 1604, Apr. 1997, at International Home Furnishings Market in High Point, North Carolina.

Natuzzi Model 1634, Oct. 1997, at International Home Furnishings Market in High Point, North Carolina.



FIG. 1.

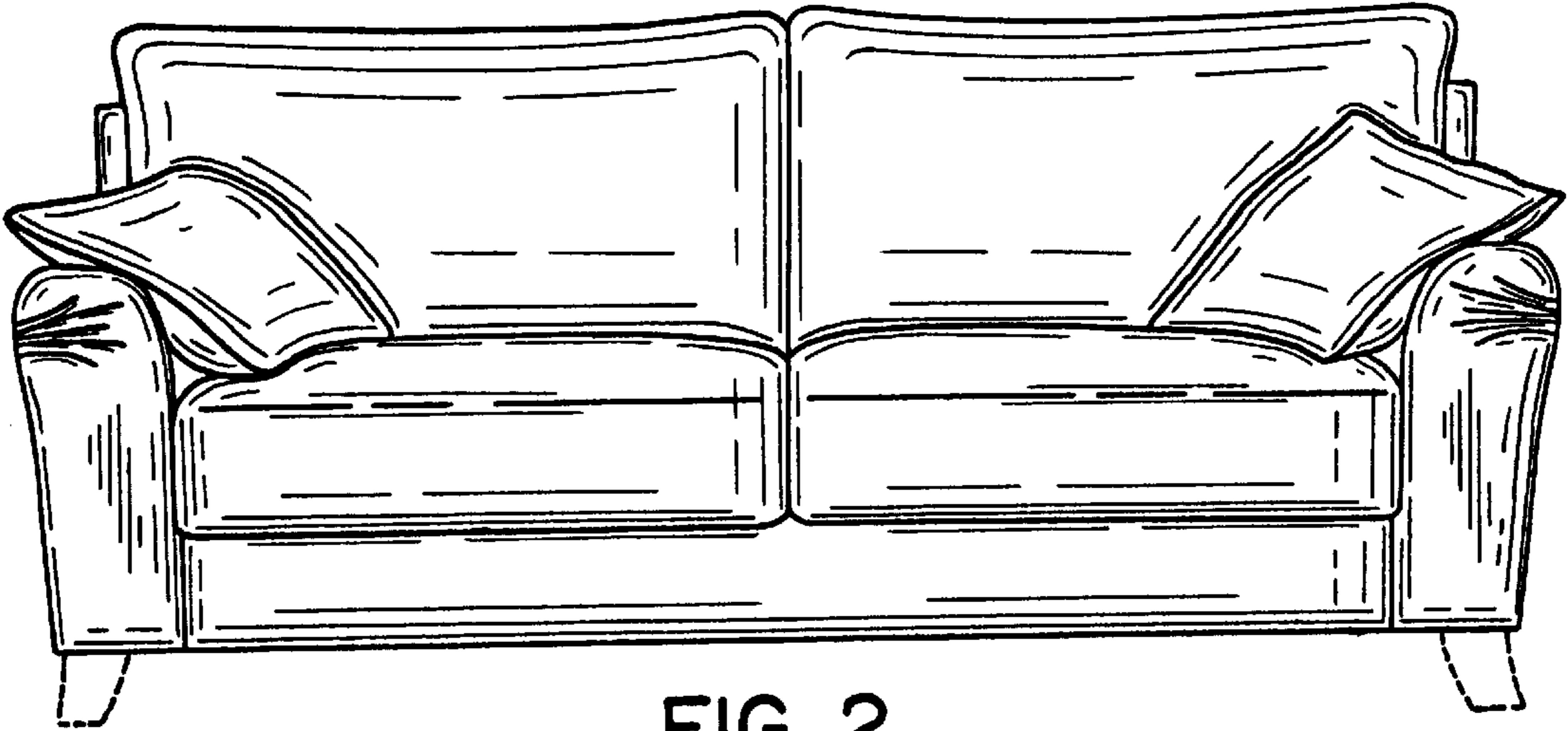

FIG. 2.

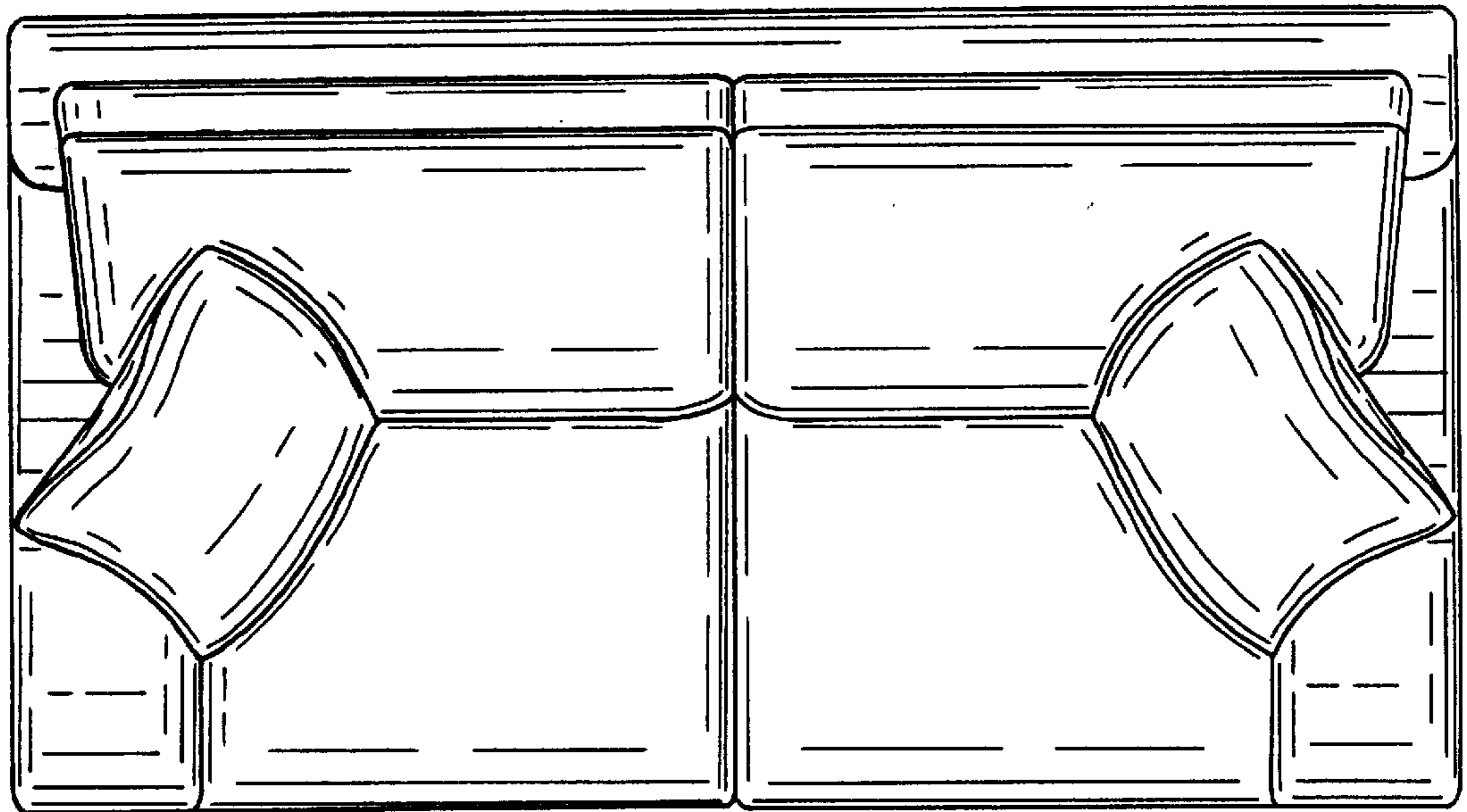

FIG. 3.

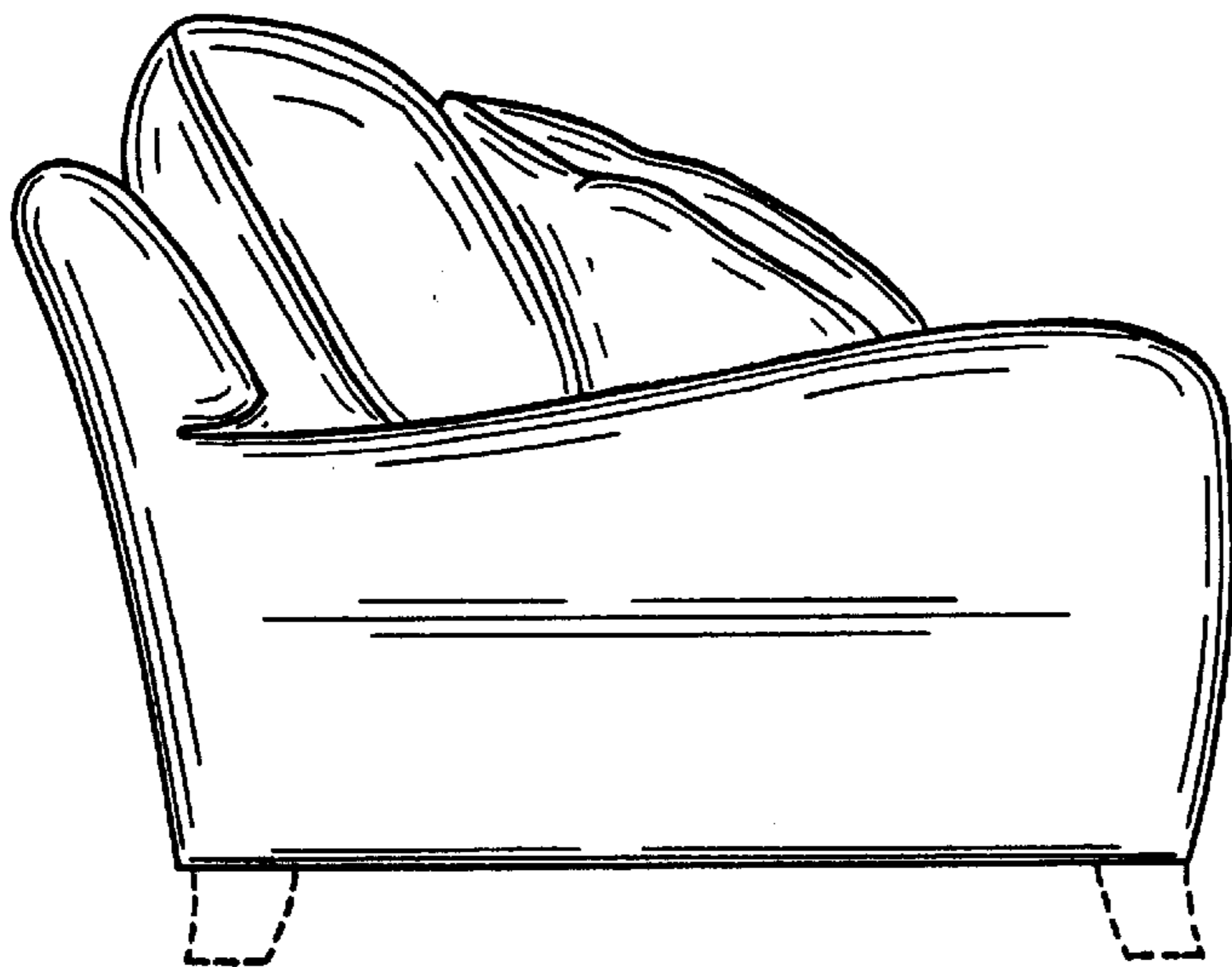

FIG. 4.

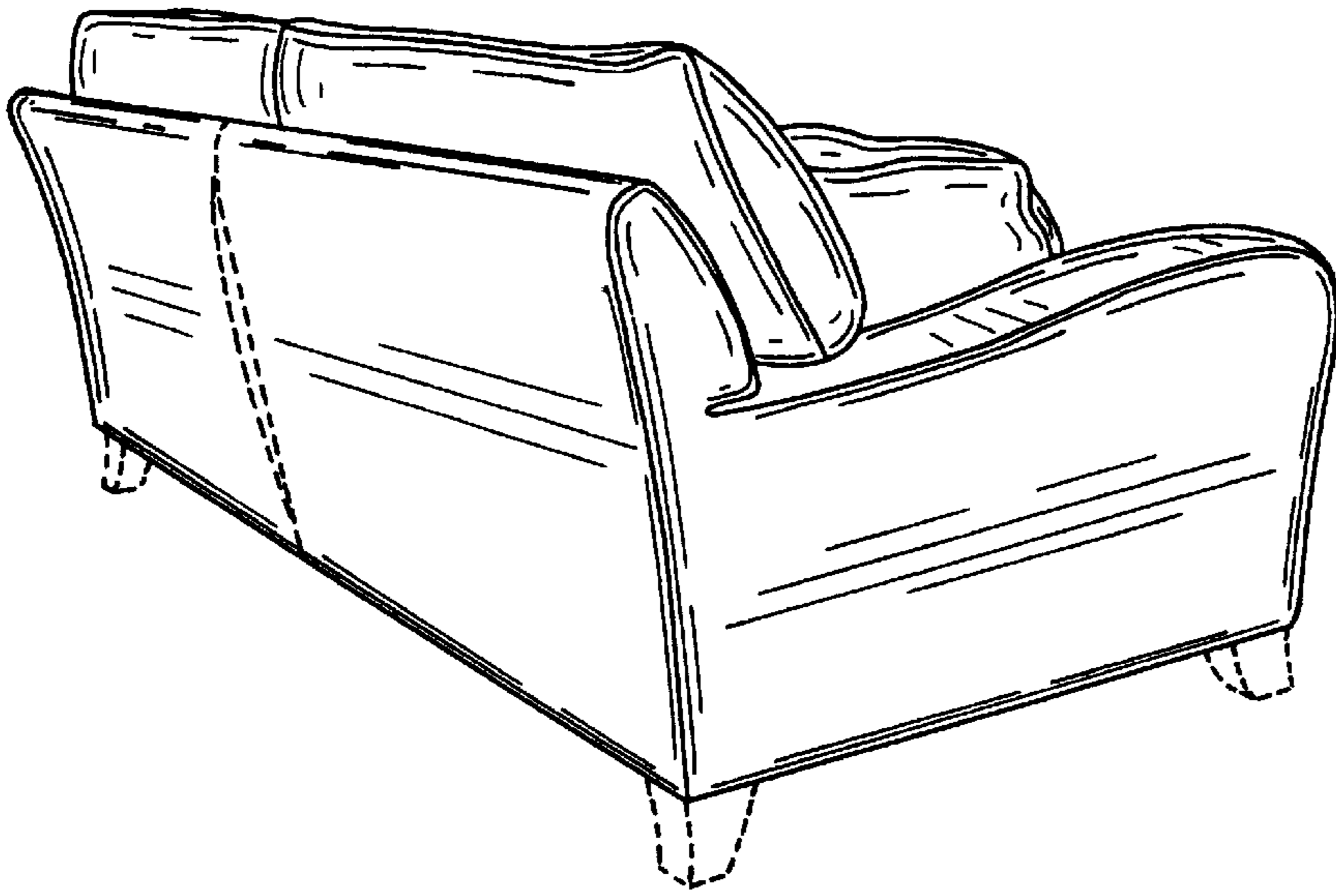

FIG. 5.

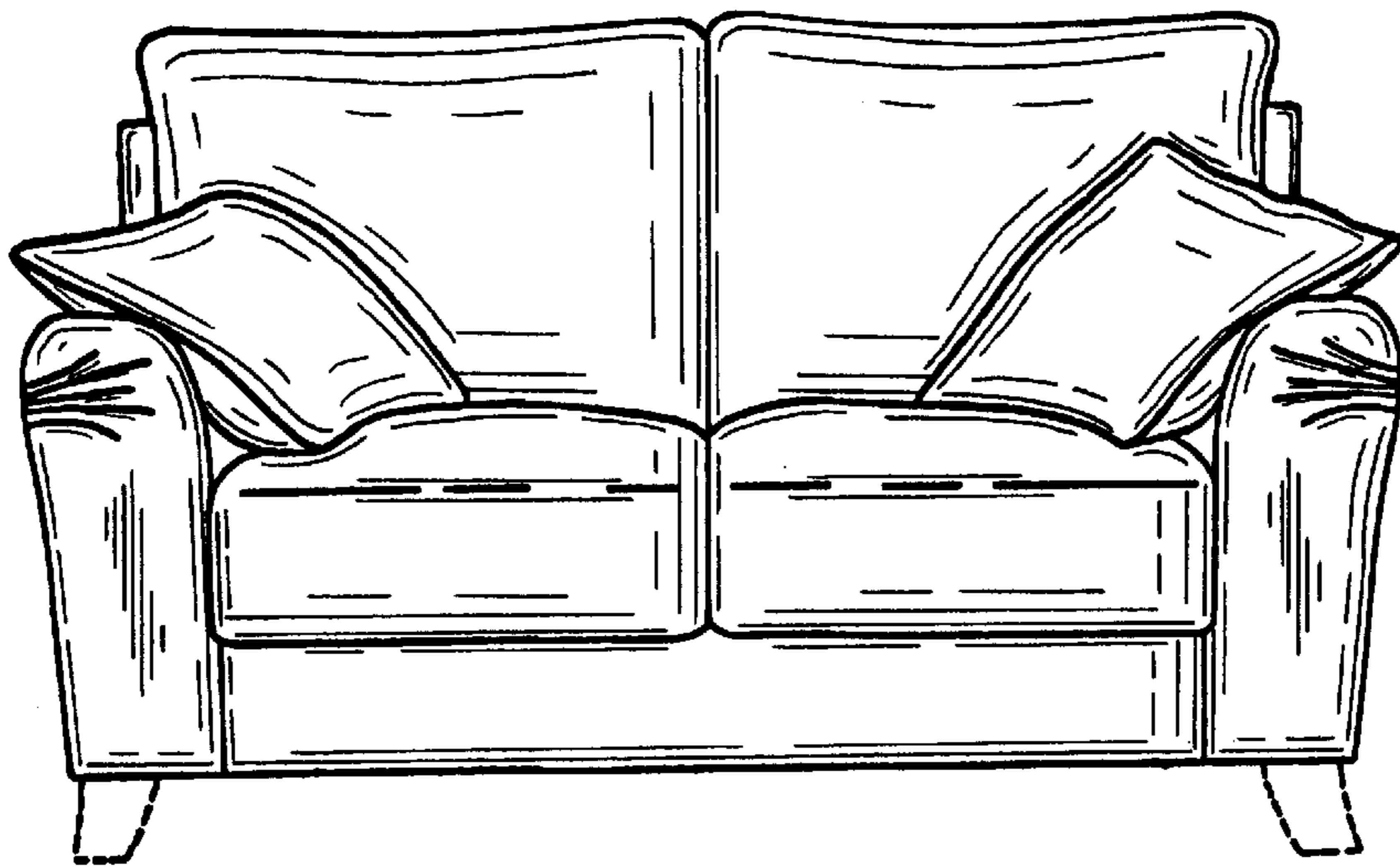

FIG. 6.

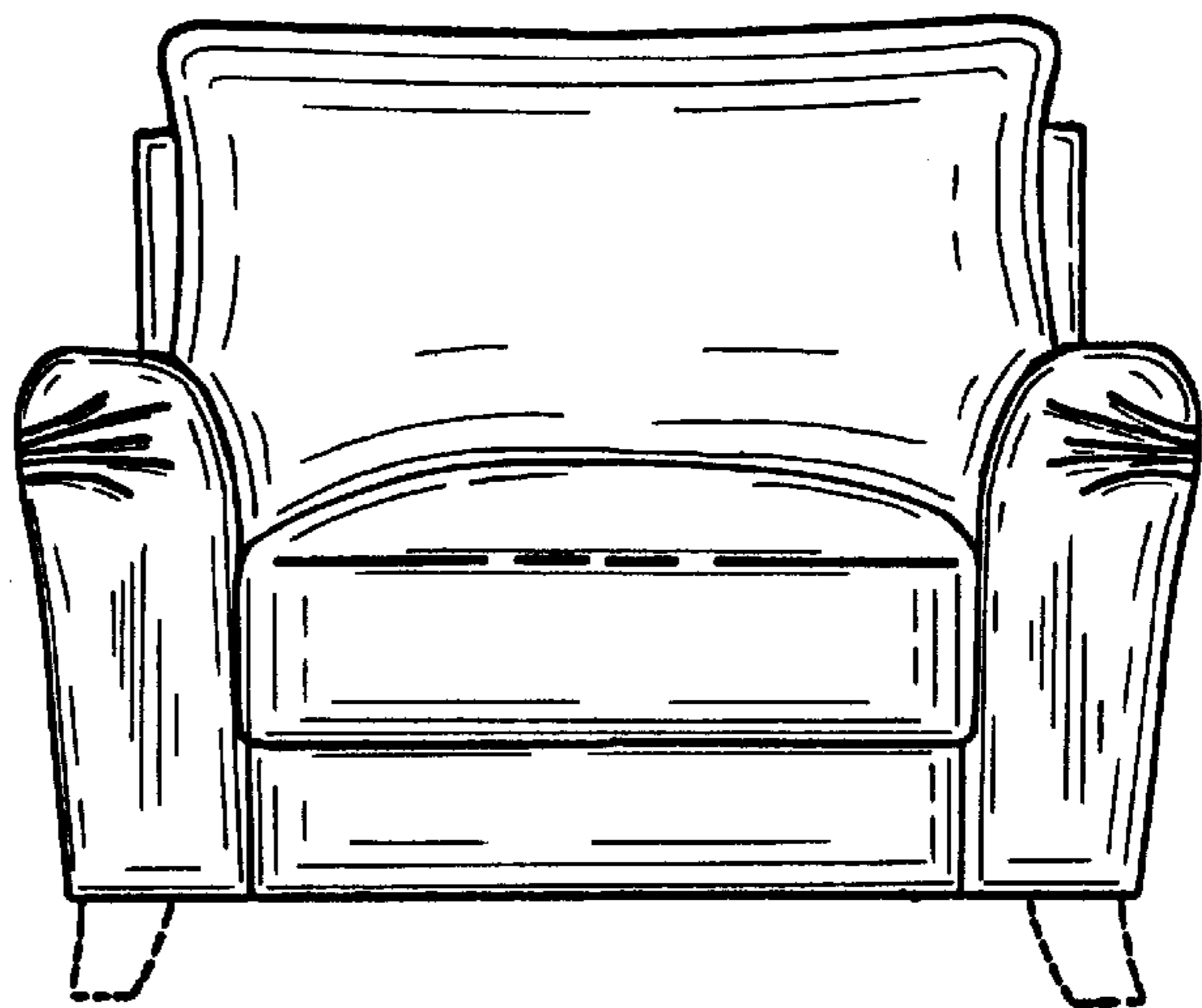

FIG. 7.