



US00D424700S

**United States Patent** [19]  
**Horton**

[11] **Patent Number: Des. 424,700**  
[45] **Date of Patent: \*\* May 9, 2000**

[54] **KIOSK**  
[75] Inventor: **Tony L. Horton**, Dallas, Tex.  
[73] Assignee: **Viad Corporation**, Grapevine, Tex.  
[\*\*] Term: **14 Years**  
[21] Appl. No.: **29/111,322**  
[22] Filed: **Sep. 28, 1999**  
[51] **LOC (7) Cl.** ..... **25-03**  
[52] **U.S. Cl.** ..... **D25/18**  
[58] **Field of Search** ..... D25/16, 1, 22-26;  
D6/432-448, 396-397, 474, 481, 472, 473,  
479, 475-478; D34/19-21; 52/34, 36.1,  
79.1, 74, 79.5; 312/194-196; 108/92-96

D. 350,829 9/1994 Horton ..... D25/16  
D. 354,816 1/1995 Horton ..... D25/16  
D. 367,777 3/1996 Arnone ..... D6/436  
D. 368,606 4/1996 Sargent, III ..... D6/481  
D. 379,664 6/1997 Horton ..... D25/16  
D. 379,665 6/1997 Horton ..... D25/16  
D. 379,666 6/1997 Horton ..... D25/16  
D. 379,667 6/1997 Horton ..... D25/16  
D. 383,859 9/1997 Hollington .  
D. 396,113 7/1998 Horton ..... D25/16  
D. 396,114 7/1998 Horton ..... D25/16  
D. 403,179 12/1998 Horton ..... D6/474  
D. 405,629 2/1999 Horton ..... D6/474  
D. 406,354 3/1999 Horton ..... D25/16  
D. 406,903 3/1999 Horton ..... D25/16  
D. 407,921 4/1999 Horton ..... D6/474  
D. 413,392 8/1999 Horton ..... D25/16  
589,971 9/1897 Kephart .  
2,836,860 6/1958 Staropoli ..... 20/1.6  
3,715,815 2/1973 Lewis ..... 35/60  
4,572,598 2/1986 Moore ..... 312/284  
5,048,857 9/1991 Stevens ..... 280/651  
5,375,899 12/1994 Wright ..... 296/21  
5,551,774 9/1996 Campbell et al. .... 312/284

[56] **References Cited**  
**U.S. PATENT DOCUMENTS**

D. 54,883 4/1920 Willett .  
D. 85,555 11/1931 Stebbings .  
D. 148,842 3/1948 Cushman ..... D30/11  
D. 149,381 4/1948 Schick ..... D80/9  
D. 152,219 12/1948 Schick ..... D80/9  
D. 152,371 1/1949 Schick ..... D80/11  
D. 200,225 2/1965 Benjamin ..... D80/11  
D. 219,579 12/1970 Wormser ..... D25/4  
D. 254,327 2/1980 Tasse ..... D25/26  
D. 256,530 8/1980 Johnson ..... D6/144  
D. 260,708 9/1981 Schindler ..... D6/144  
D. 265,617 8/1982 Sauroge, III et al. .... D6/144  
D. 279,408 6/1985 Davenport ..... D25/25  
D. 288,040 2/1987 LeBlanc ..... D6/473  
D. 288,609 3/1987 Watkins ..... D25/11  
D. 302,221 7/1989 Suttles et al. .... D6/481  
D. 313,077 12/1990 Minarro ..... D25/16  
D. 326,024 5/1992 Boyd et al. .... D6/480  
D. 341,458 11/1993 Carroll ..... D34/20  
D. 346,867 5/1994 Montilla ..... D25/16  
D. 348,367 7/1994 Geisen et al. .... D6/481

*Primary Examiner*—Doris Clark  
*Attorney, Agent, or Firm*—Locke Liddell & Sapp LLP

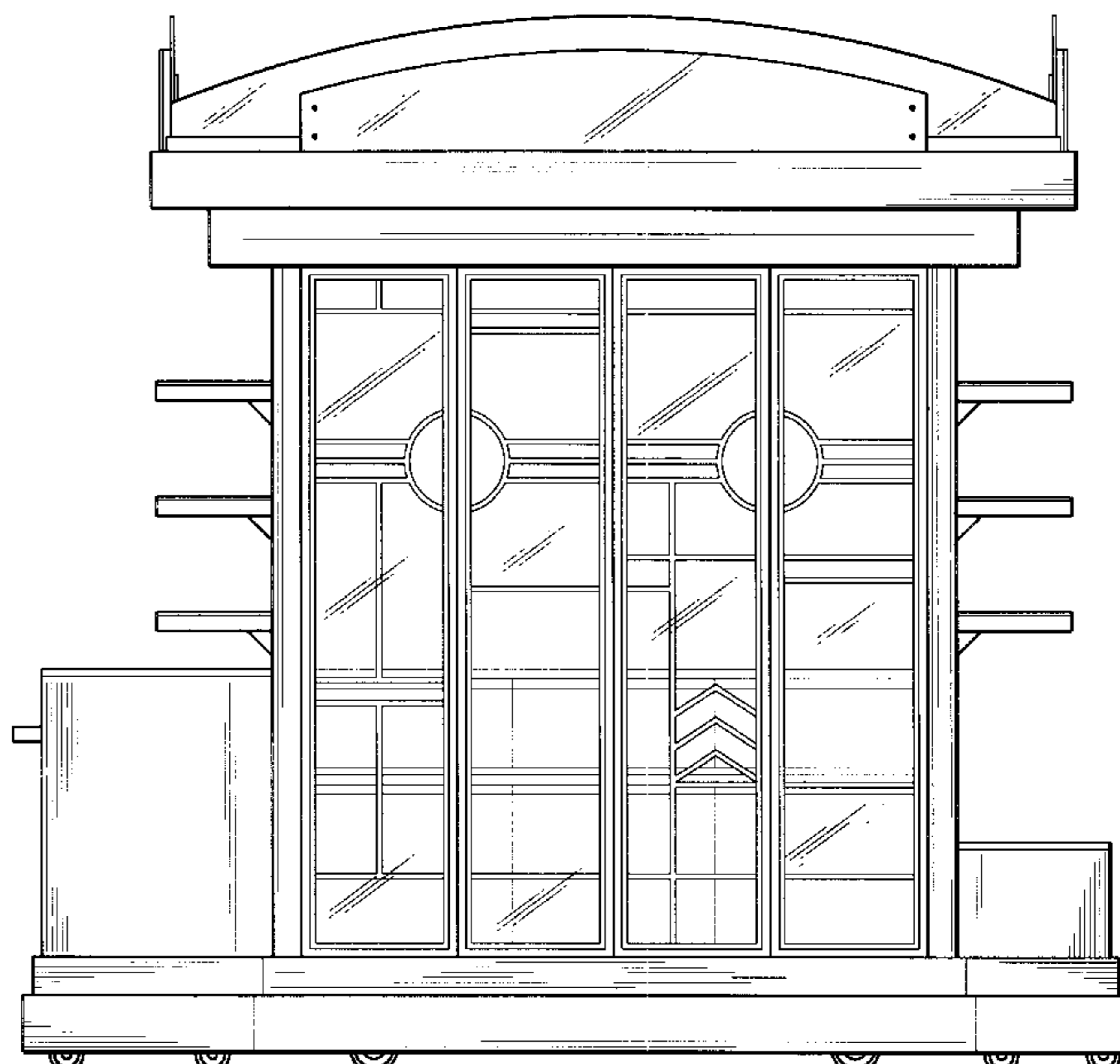
[57] **CLAIM**

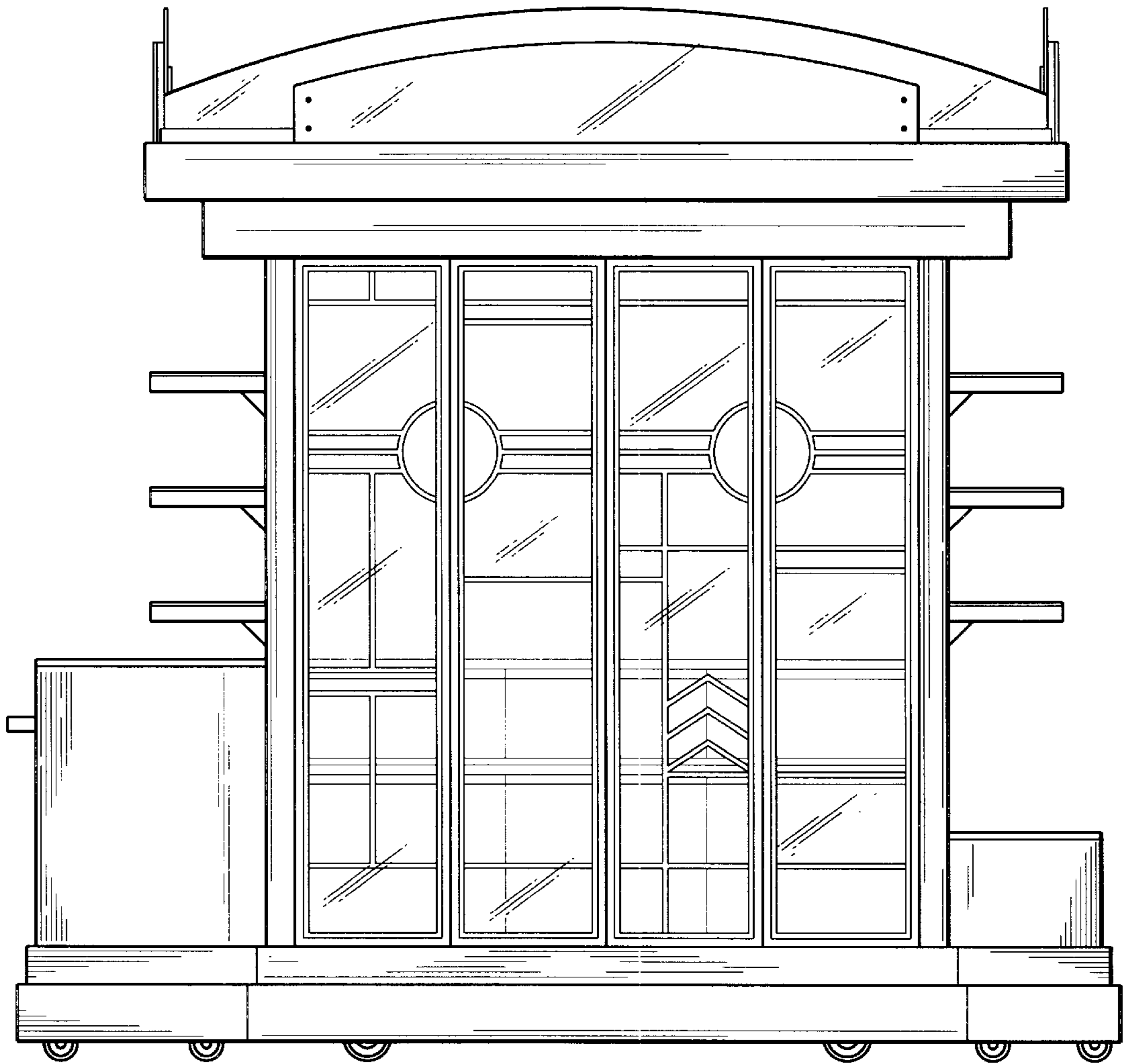
The ornamental design for “kiosk,” as shown and described.

**DESCRIPTION**

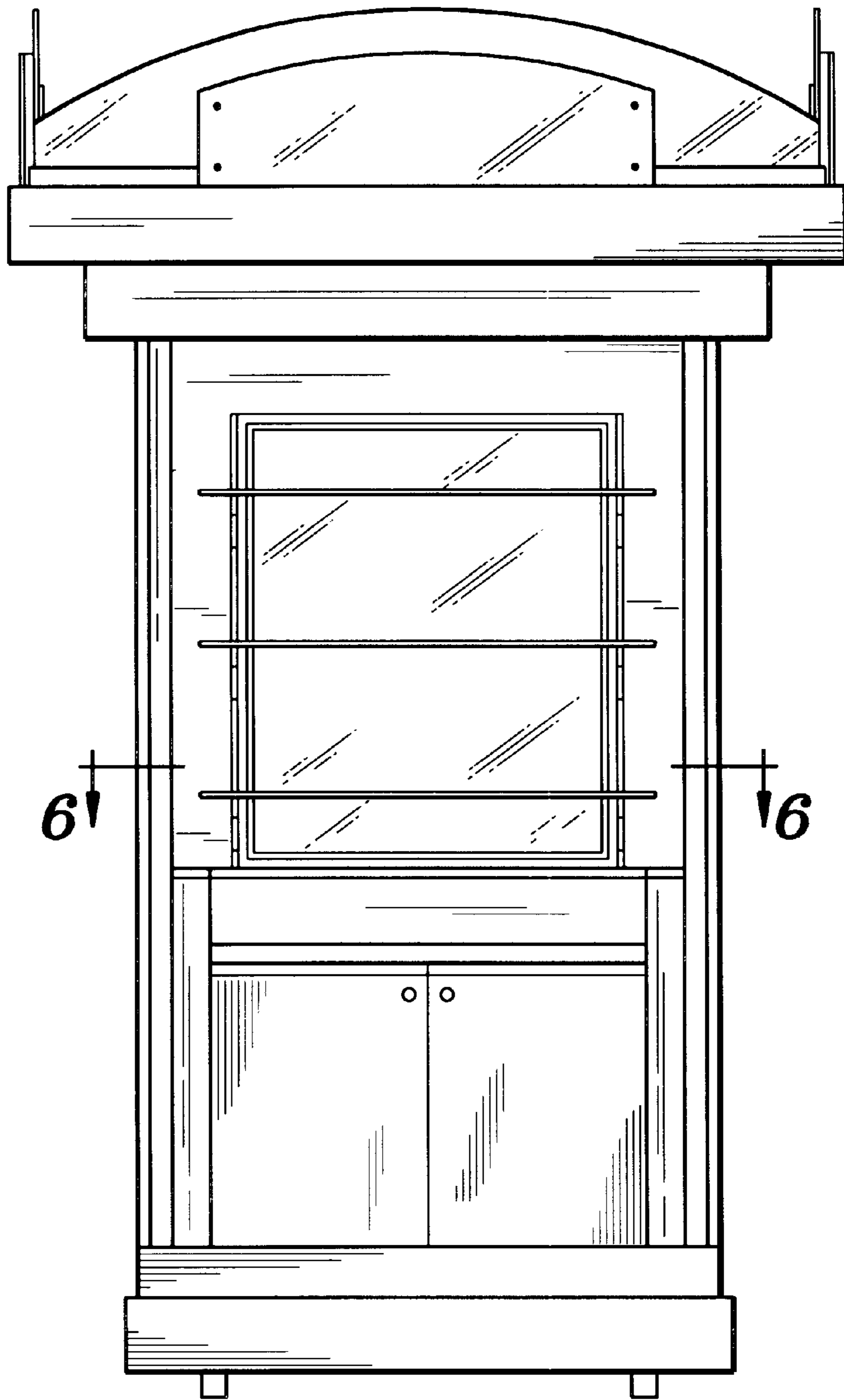
FIG. 1 is a front elevational view of a kiosk showing my new design, the rear elevational view being identical thereto; FIG. 2 is a left side elevational view thereof; FIG. 3 is a right side elevational view thereof; FIG. 4 is a top plan view thereof; FIG. 5 is a bottom plan view thereof; and, FIG. 6 is a sectional view thereof taken generally along sectional lines 6—6 of FIG. 2.

**1 Claim, 5 Drawing Sheets**

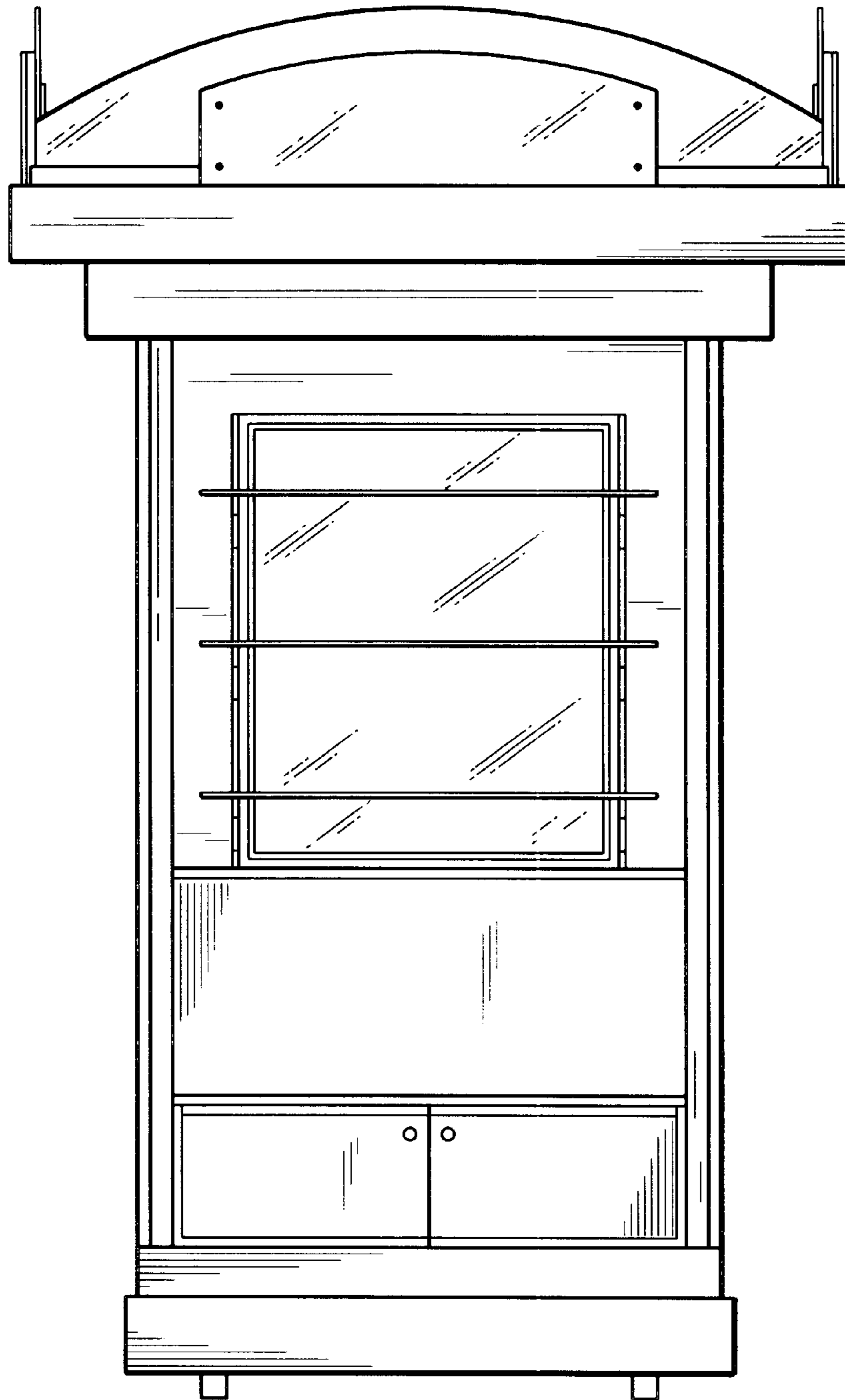




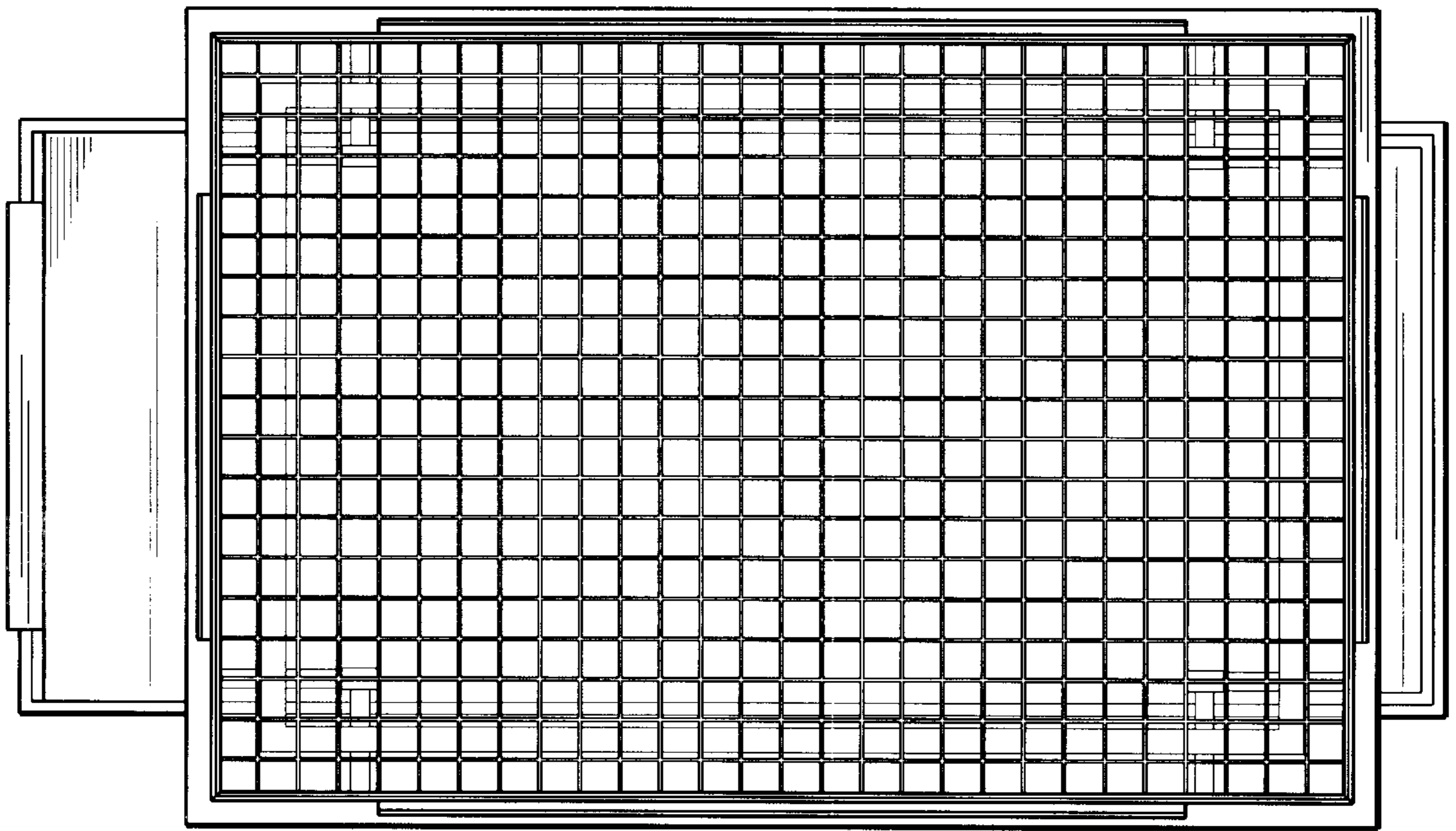
*FIG. 1*



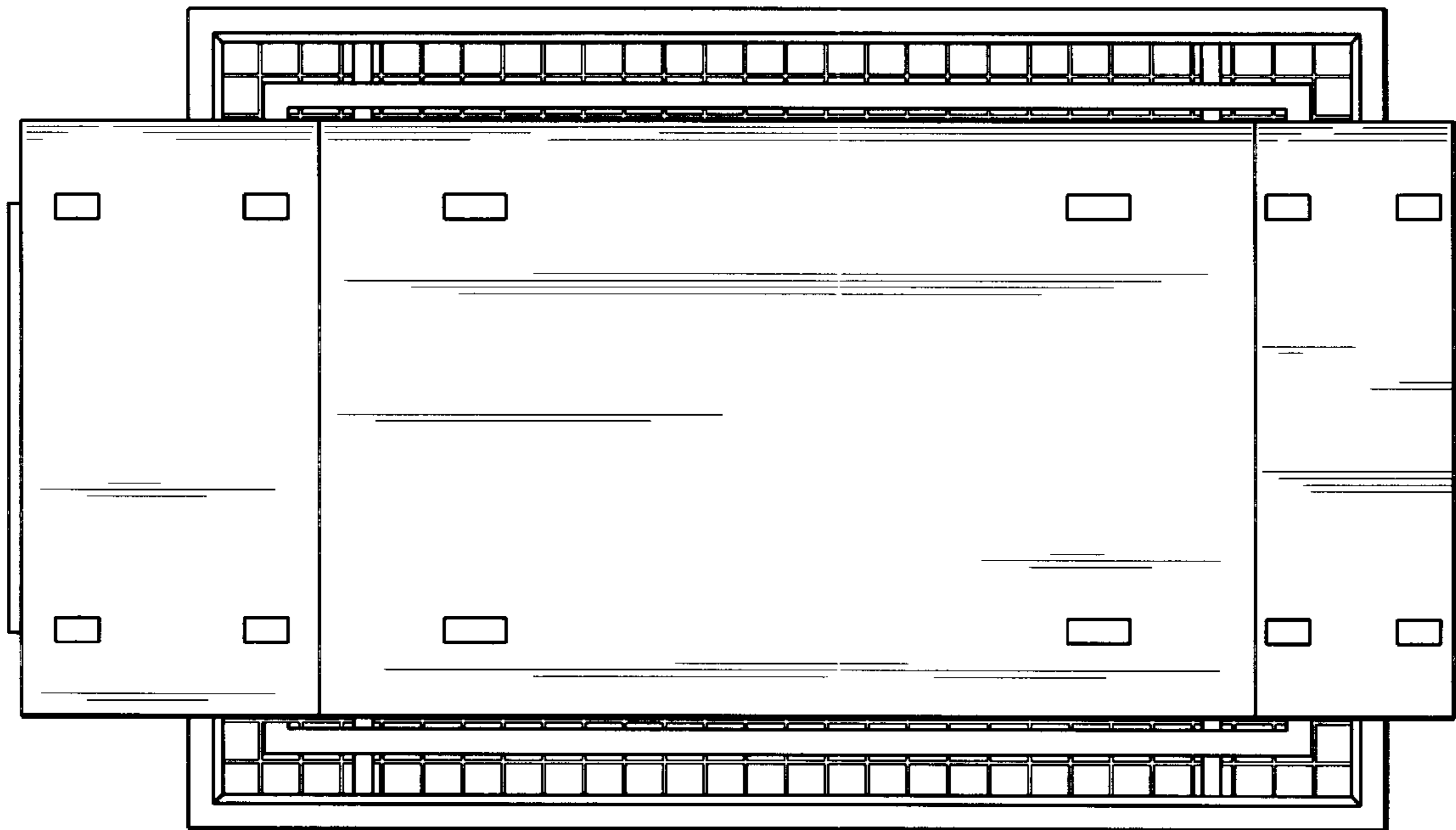
**FIG. 2**



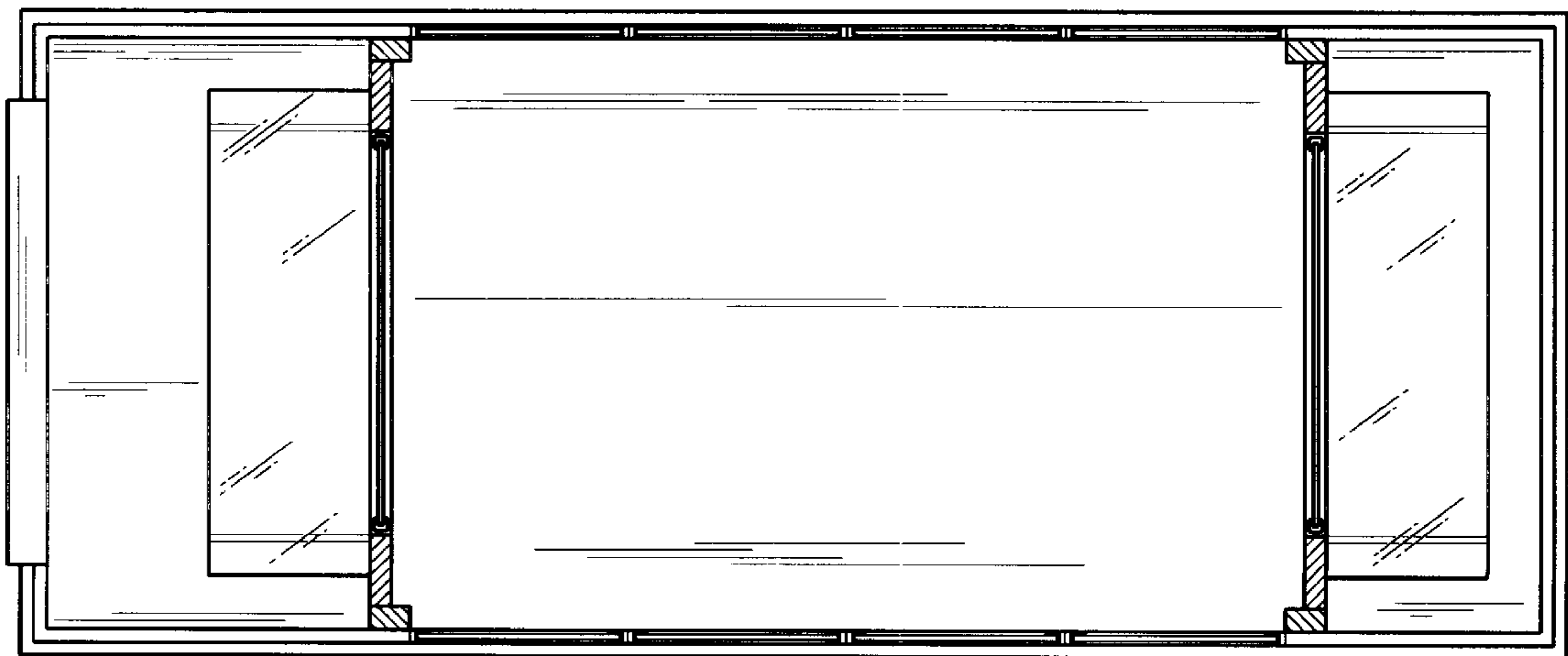
*FIG. 3*



*FIG. 4*



*FIG. 5*



*FIG. 6*