



US00D424619S

United States Patent [19]

Katami

[11] **Patent Number: Des. 424,619**

[45] **Date of Patent: ** May 9, 2000**

[54] **CORRECTION TAPE DISPENSER**

[75] Inventor: **Kazunori Katami**, Tsurugashima, Japan

[73] Assignee: **Tombow Pencil Co., Ltd.**, Kita-ku, Japan

[**] Term: **14 Years**

[21] Appl. No.: **29/089,426**

[22] Filed: **Jun. 15, 1998**

[51] **LOC (7) Cl. 19-02**

[52] **U.S. Cl. D19/69; D19/67; D19/53**

[58] **Field of Search** D19/65, 67, 68, D19/69, 70, 53, 99, 100; D10/72; 225/6, 7, 19, 24, 25, 34, 35, 45, 56, 65, 77, 89; 156/510, DIG. 48, 523, 527, 577, 576, 540, 584; 242/55.3

[56] **References Cited**

U.S. PATENT DOCUMENTS

D. 337,787 7/1993 Oga et al. D19/69

| | | | | |
|------------|---------|--------------------|-------|----------|
| D. 378,532 | 3/1997 | Suzuki | | D19/69 |
| 1,572,063 | 2/1926 | Black | | D19/69 X |
| 2,400,435 | 5/1946 | Nelson et al. | | 156/527 |
| 5,670,014 | 9/1997 | Mendelovich et al. | | 156/523 |
| 5,772,840 | 6/1998 | Morinaga | | 156/540 |
| 5,851,347 | 12/1998 | Rodriguez | | 156/576 |

Primary Examiner—Martie K. Holtje
Attorney, Agent, or Firm—Garrison Morris & Haight, PLLC

[57] **CLAIM**

The ornamental design for a correction tape dispenser, as shown and described.

DESCRIPTION

FIG. 1 is a perspective view of a correction tape dispenser showing my new design;
FIG. 2 is a left-side view thereof;
FIG. 3 is a right-side view thereof;
FIG. 4 is a top view thereof;
FIG. 5 is a bottom view thereof;
FIG. 6 is a front view thereof; and,
FIG. 7 is a rear view thereof.

1 Claim, 5 Drawing Sheets

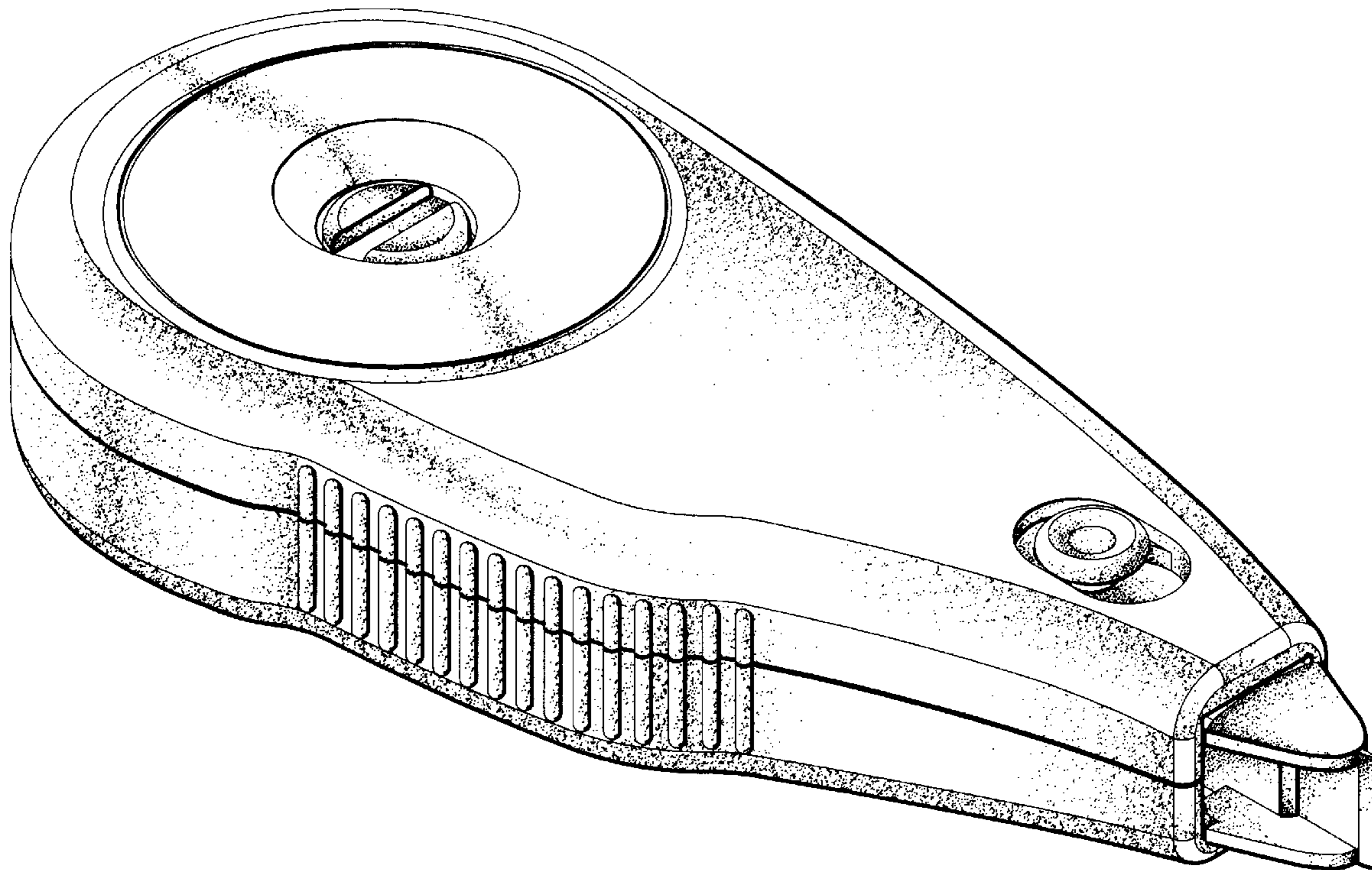

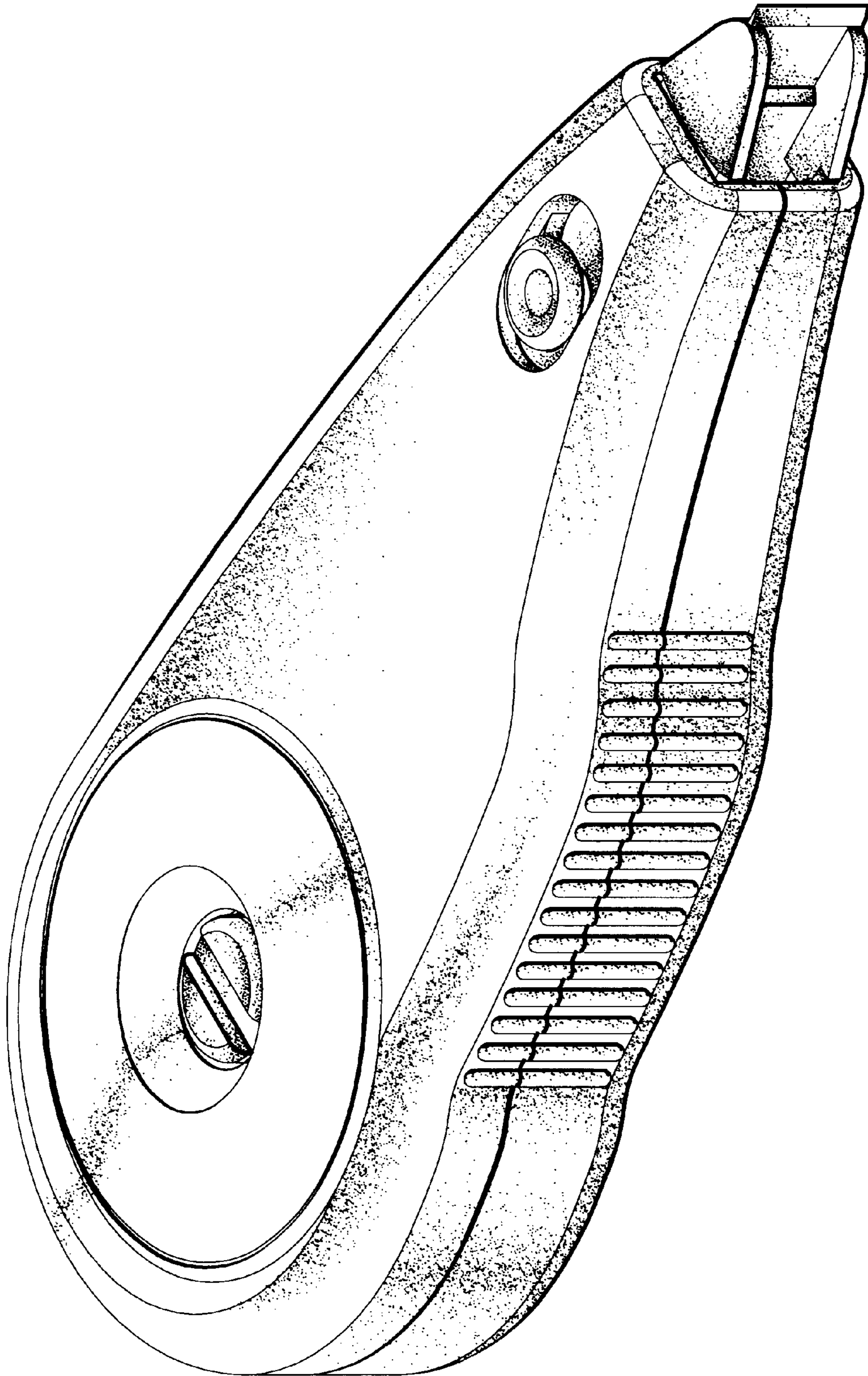

FIG 1

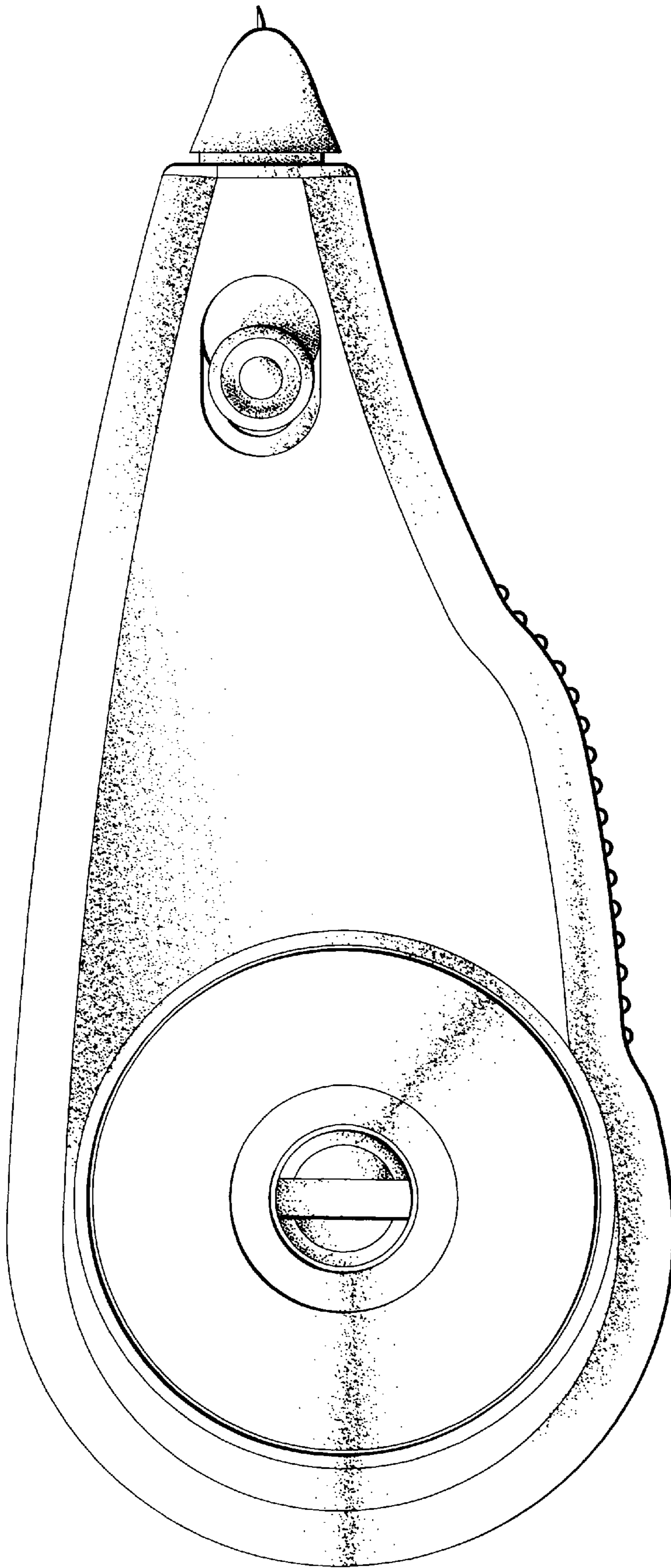

FIG 2

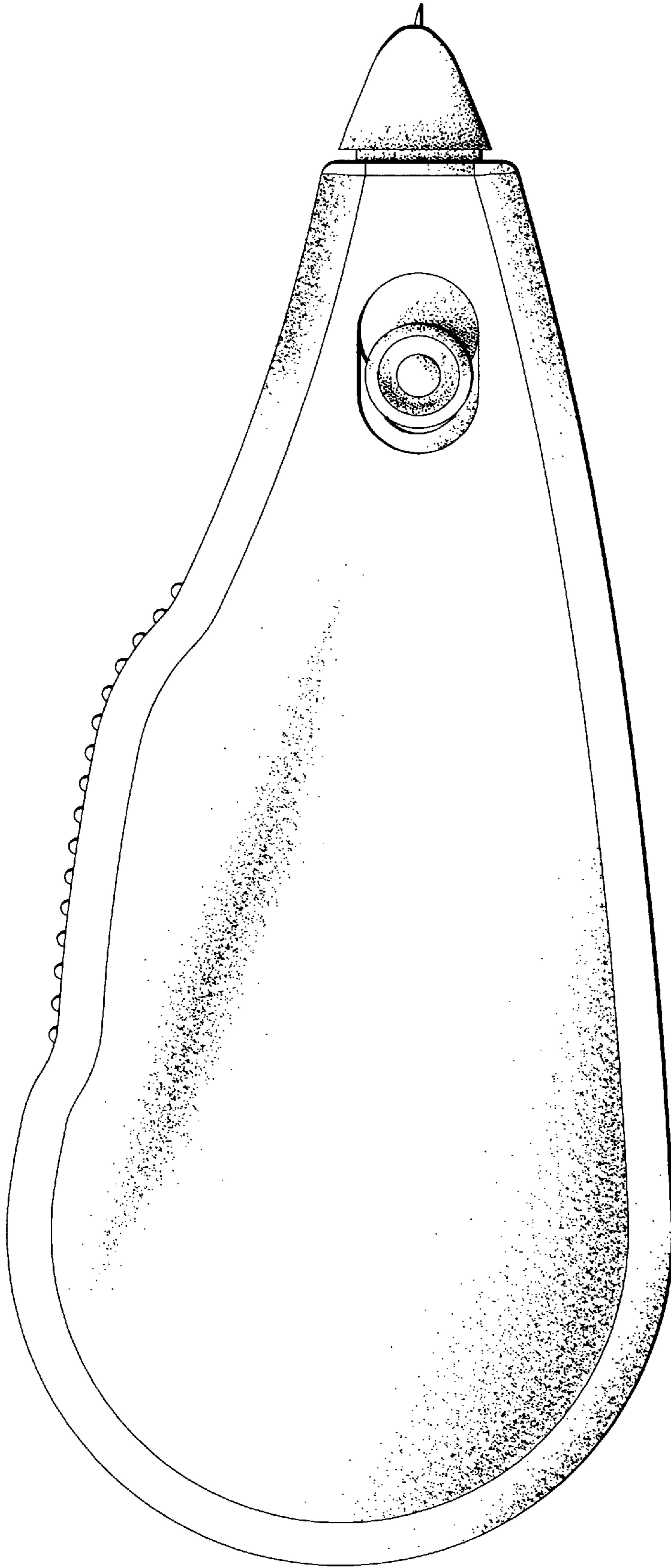

FIG 3

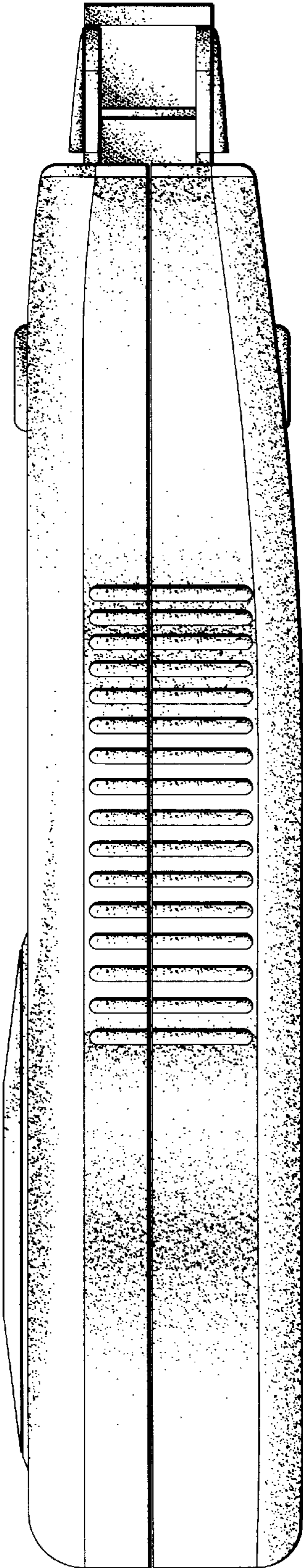

FIG 4

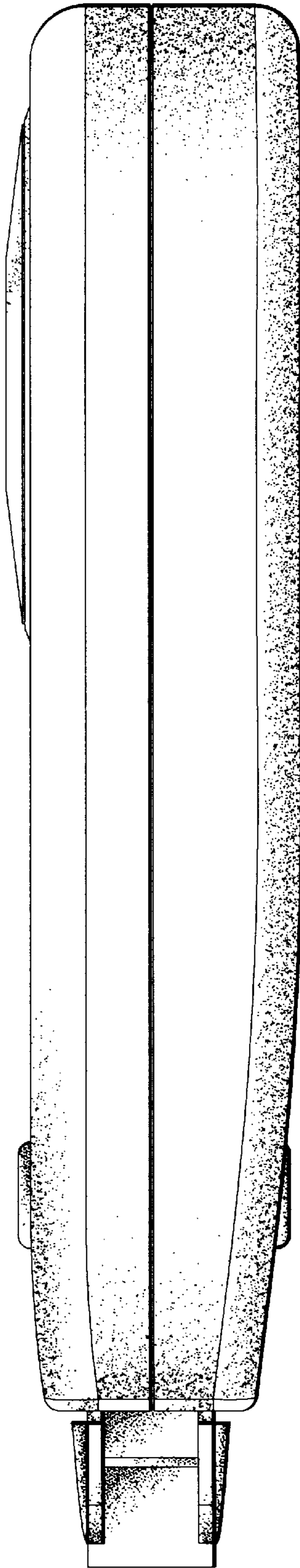

FIG 5

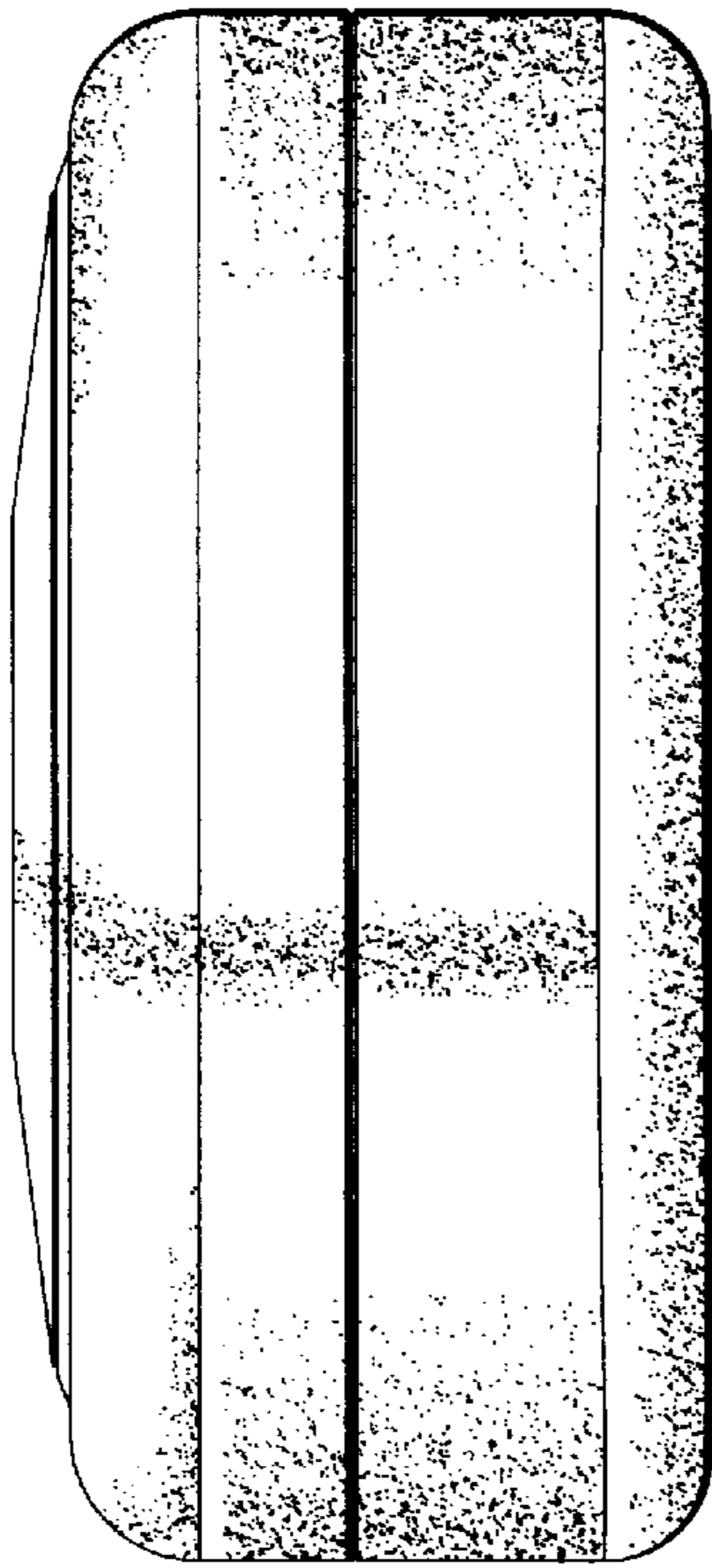

FIG 7

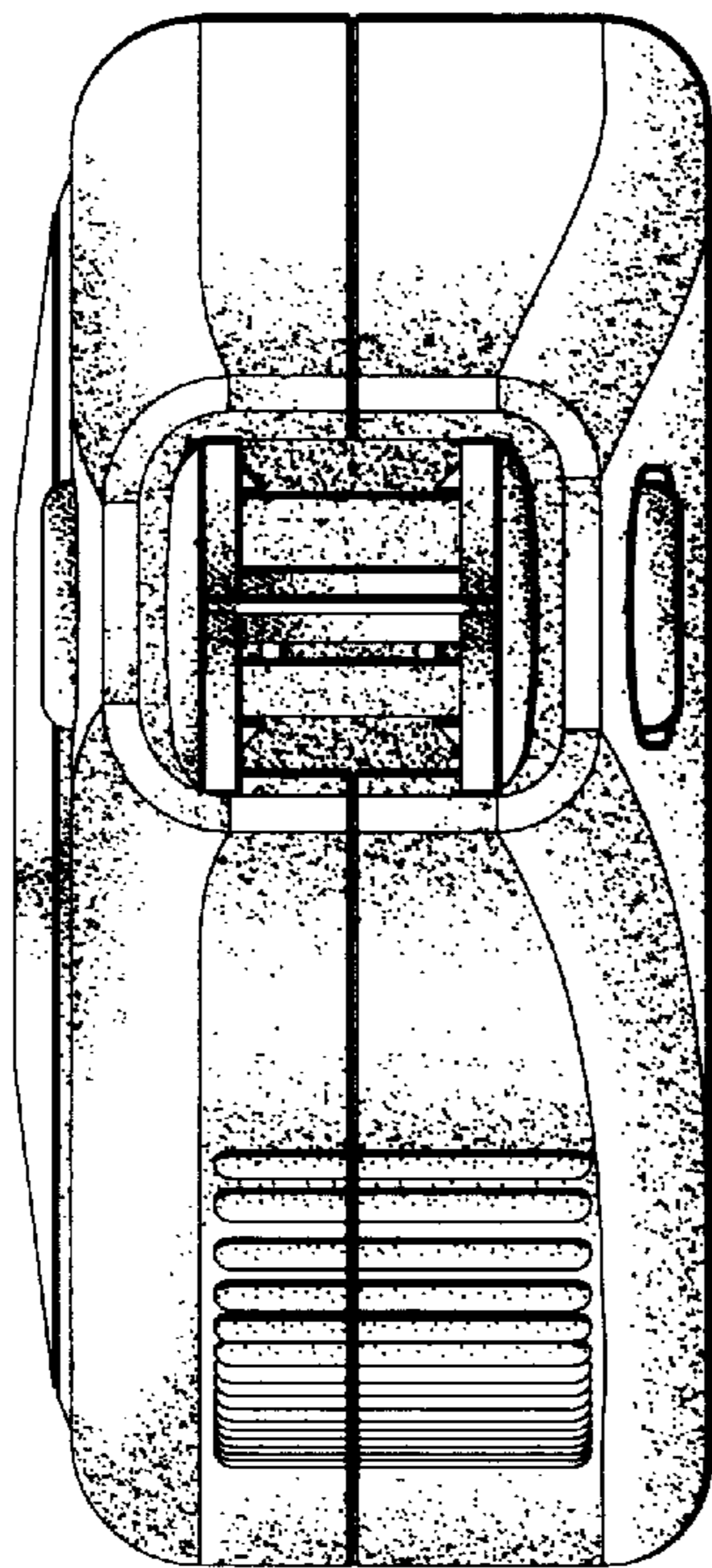

FIG 6