



US00D424591S

# United States Patent [19] Goff et al.

[11] **Patent Number: Des. 424,591**  
[45] **Date of Patent: \*\* May 9, 2000**

[54] **ILLUMINATED MAGNIFIER AND STAND**

[75] Inventors: **James A. Goff**, Webster; **Richard J. Stryker**, Scottsville; **Howard Scott Ryan**, Skaneateles; **Deborah A. Laun**, Syracuse, all of N.Y.

[73] Assignee: **Bausch & Lomb, Incorporated**, Rochester, N.Y.

[\*\*] Term: **14 Years**

[21] Appl. No.: **29/103,754**

[22] Filed: **Apr. 21, 1999**

[51] **LOC (7) Cl.** ..... **16-06**

[52] **U.S. Cl.** ..... **D16/135**

[58] **Field of Search** ..... D16/130, 134,  
D16/135, 136; 359/798, 799, 800, 801,  
802, 804, 810, 811; 362/157, 253, 109;  
D26/44, 51

[56] **References Cited**

**U.S. PATENT DOCUMENTS**

D. 76,519	10/1928	Brady .	
D. 168,546	1/1953	Igler et al. ....	D16/135
D. 217,506	5/1970	Knoetgen .	
D. 298,634	11/1988	Yuen .....	D16/135
D. 303,977	10/1989	Steel et al. .	
D. 305,664	1/1990	Speaker .	
D. 306,175	2/1990	Steel et al. .	
D. 324,060	2/1992	Huang .	
D. 336,655	6/1993	Lee .....	D16/135
D. 372,924	8/1996	Fisherman .	
D. 380,483	7/1997	Lee .....	D16/135

D. 394,272	5/1998	Hon .....	D16/135
D. 406,853	3/1999	Chan .....	D16/135
2,150,916	3/1939	Forgea .....	359/802
4,944,574	7/1990	Roote et al. .	

*Primary Examiner*—Paula A. Mortimer  
*Attorney, Agent, or Firm*—Mary Anne Magee

[57] **CLAIM**

The ornamental design for illuminated magnifier and stand, as shown and described.

**DESCRIPTION**

FIG. 1 is a front perspective view of the illuminated magnifier and stand showing our new design; FIG. 2 is a side elevational view thereof; FIG. 3 is a top plan view thereof; FIG. 4 is a bottom plan view thereof; FIG. 5 is a front elevational view thereof; FIG. 6 is a rear elevational view thereof; FIG. 7 is a front perspective view of the detachable illuminated magnifier shown separately for ease of illustration; FIG. 8 is a side elevational view thereof; FIG. 9 is a top plan view thereof; FIG. 10 is a bottom plan view thereof; FIG. 11 is a front elevational view thereof; FIG. 12 is a rear elevational view thereof; FIG. 13 is a front perspective view of the stand shown separately for ease of illustration; FIG. 14 is a side elevational view thereof; FIG. 15 is a front elevational view thereof; FIG. 16 is a rear elevational view thereof; FIG. 17 is a top plan view thereof; and, FIG. 18 is a bottom plan view thereof.

**1 Claim, 12 Drawing Sheets**

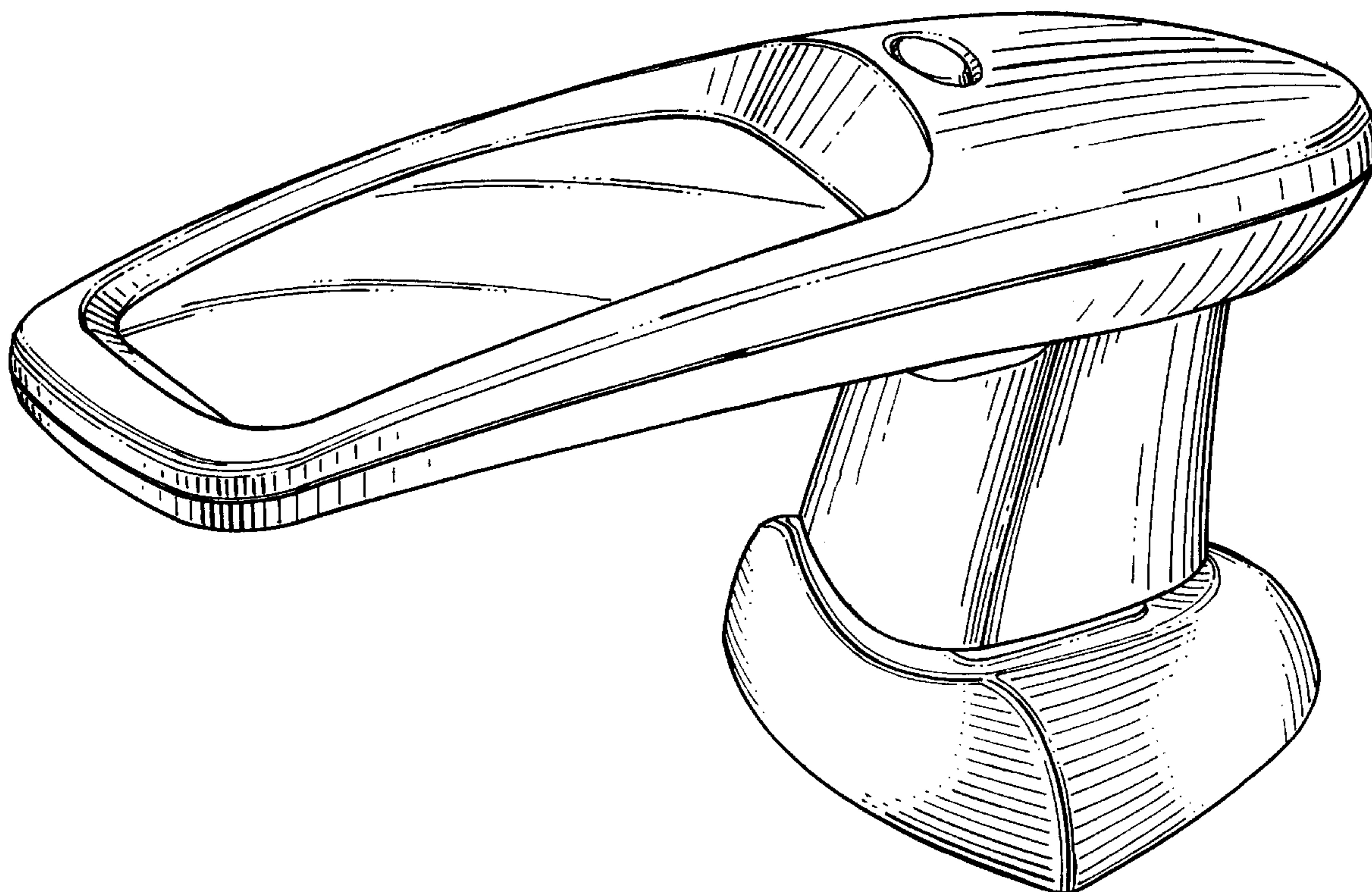

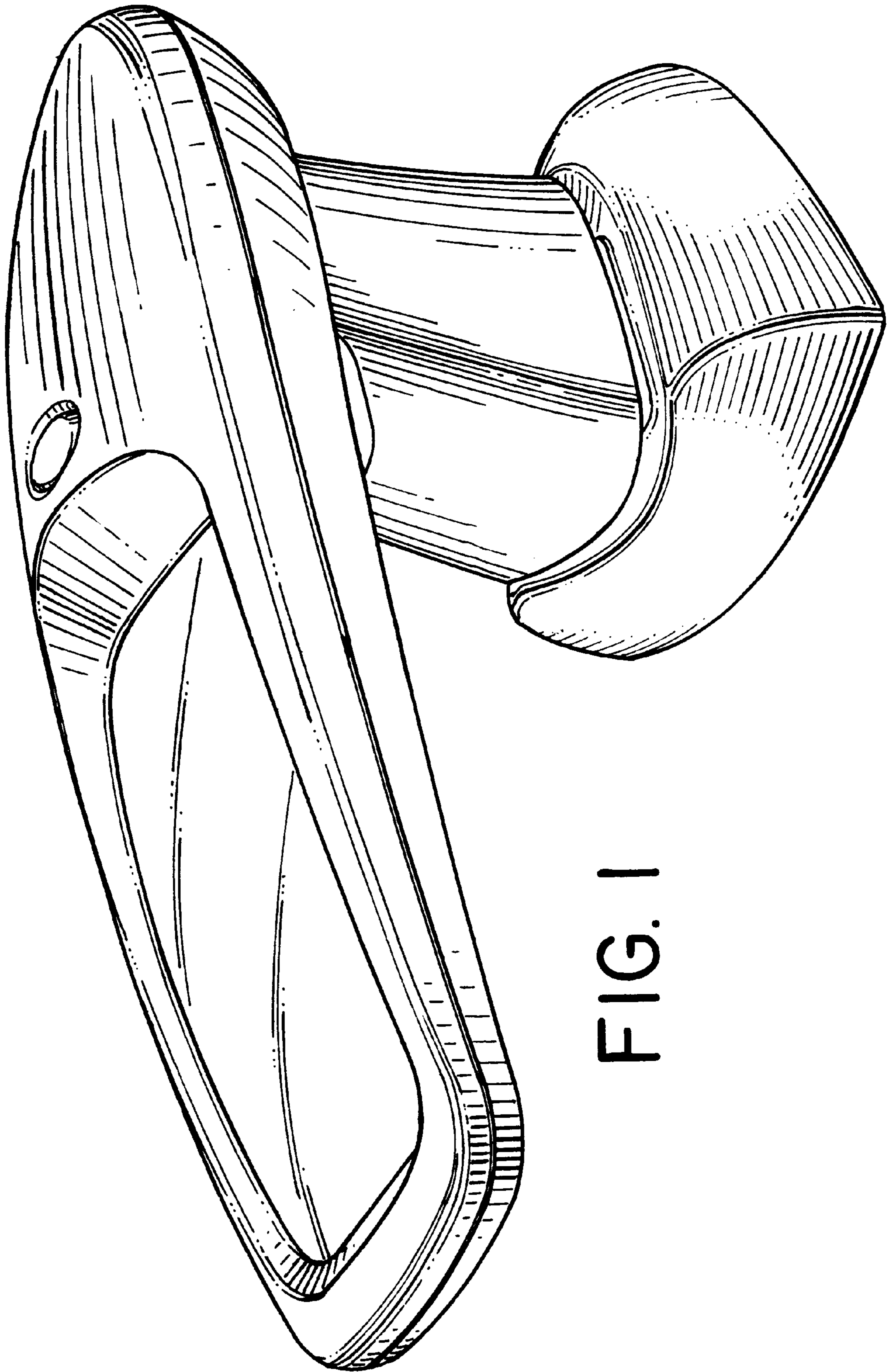

FIG. 1

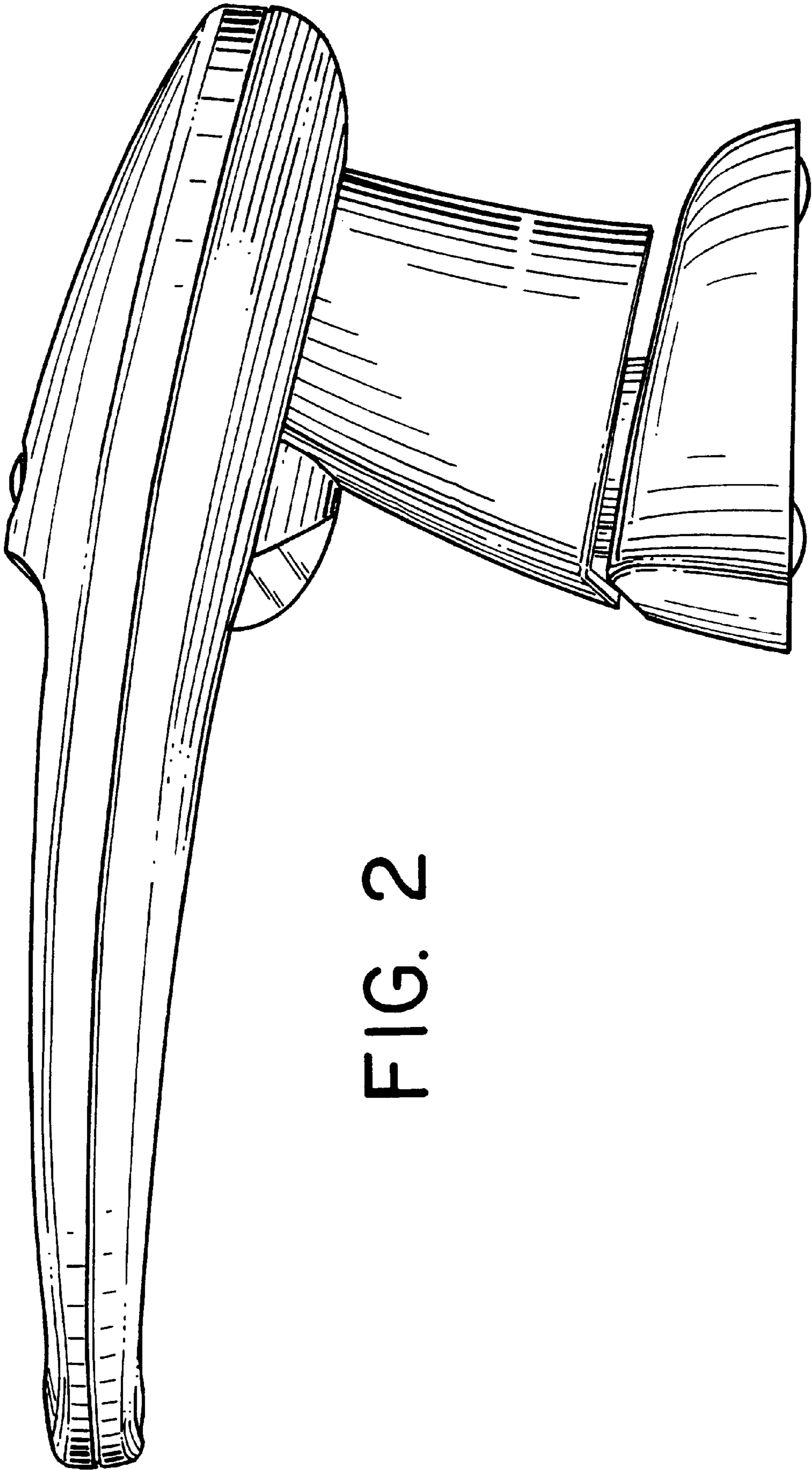

FIG. 2

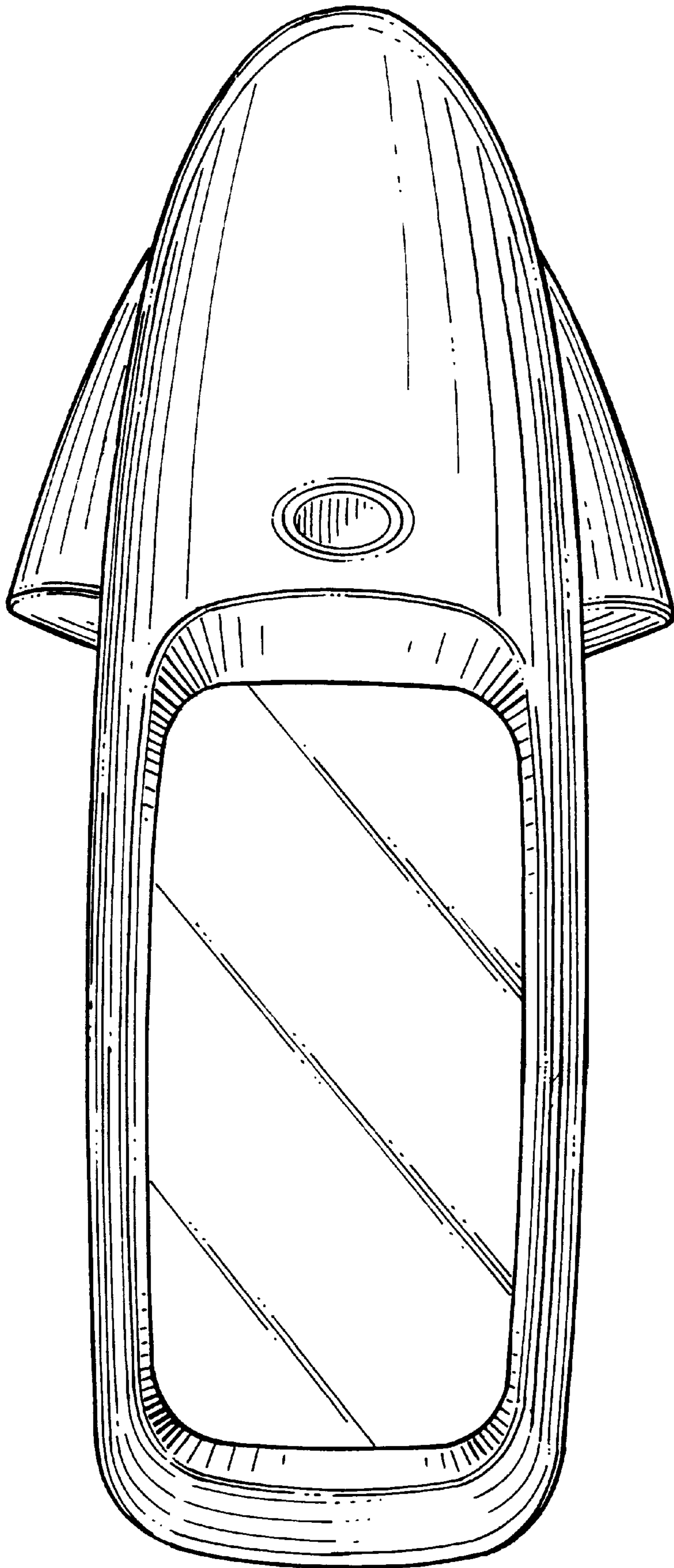

FIG. 3

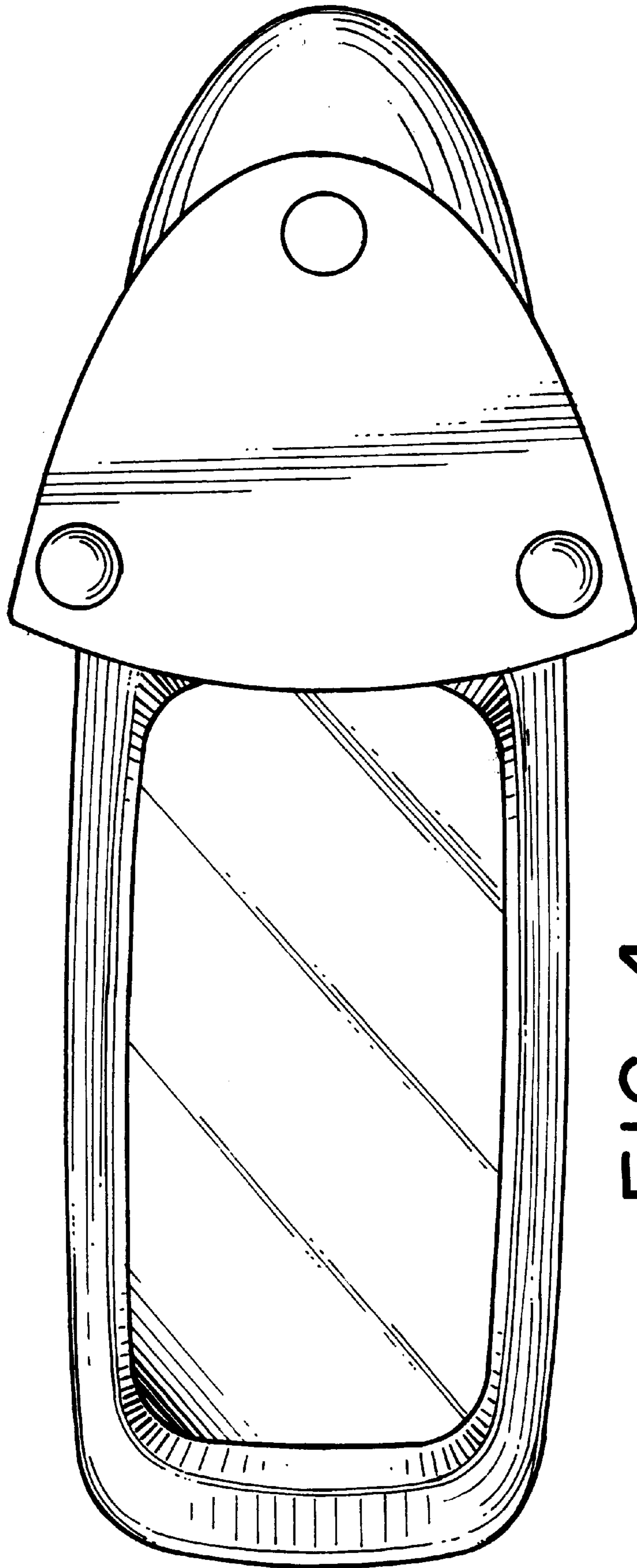

FIG. 4

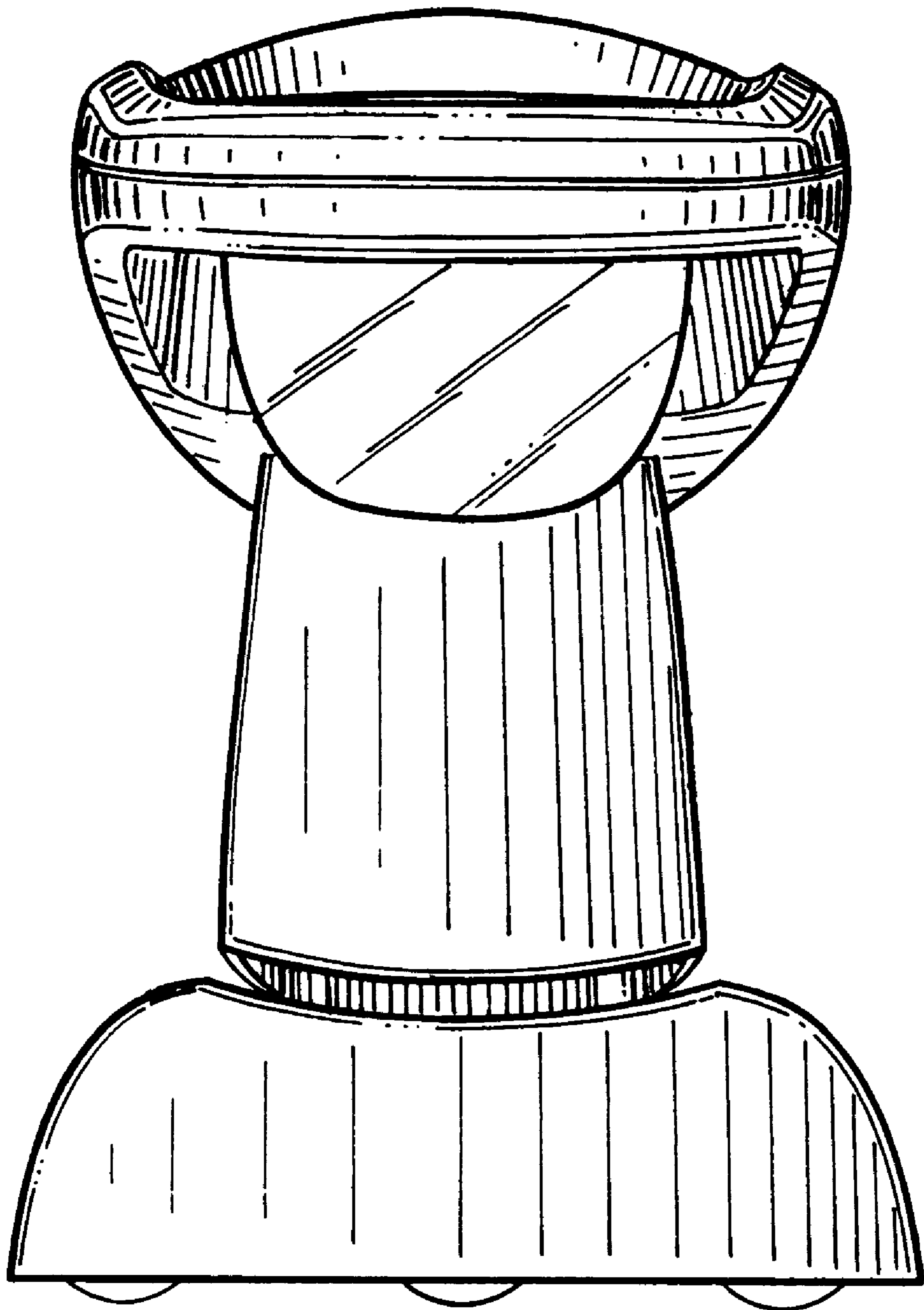

FIG. 5

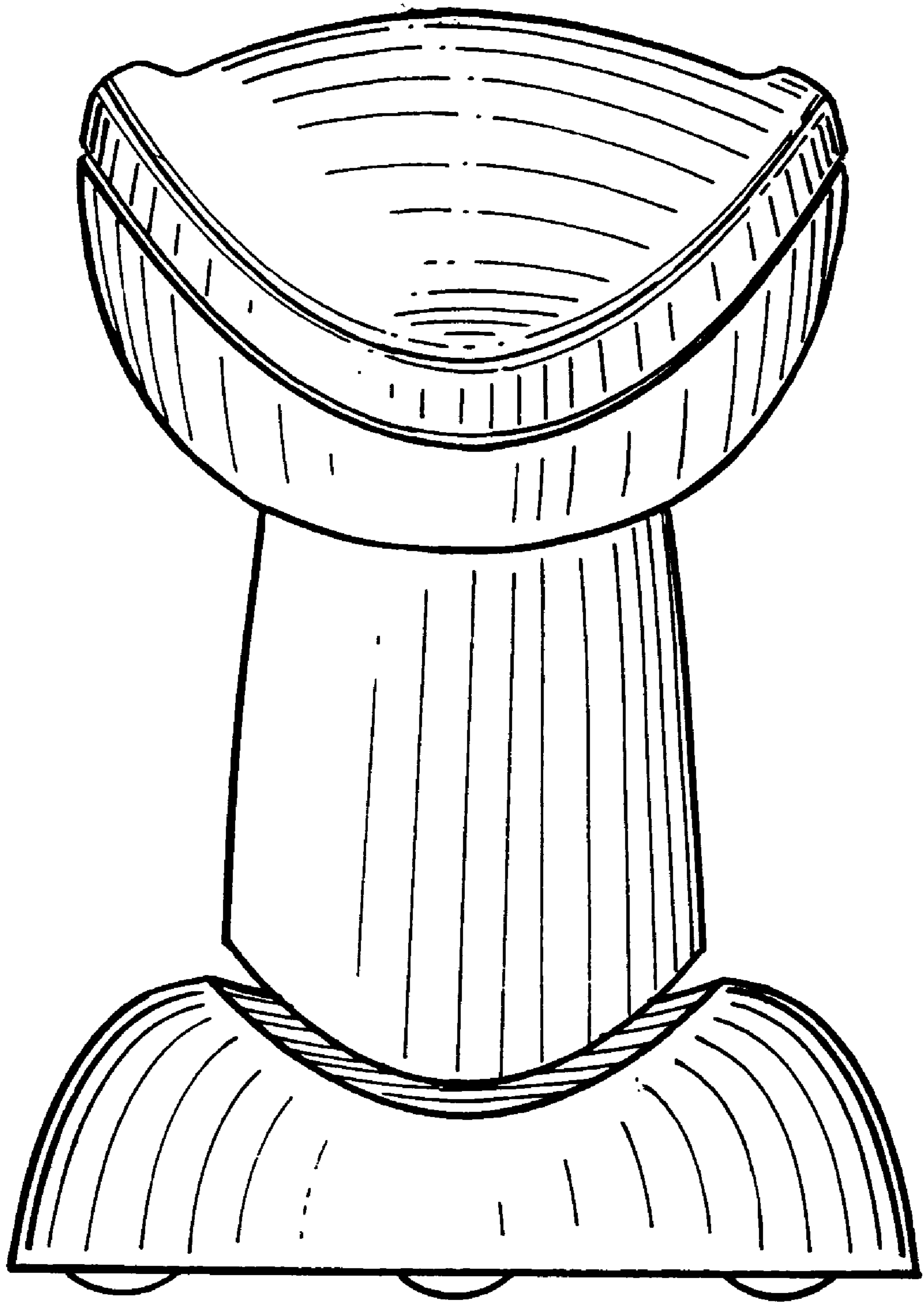

FIG. 6

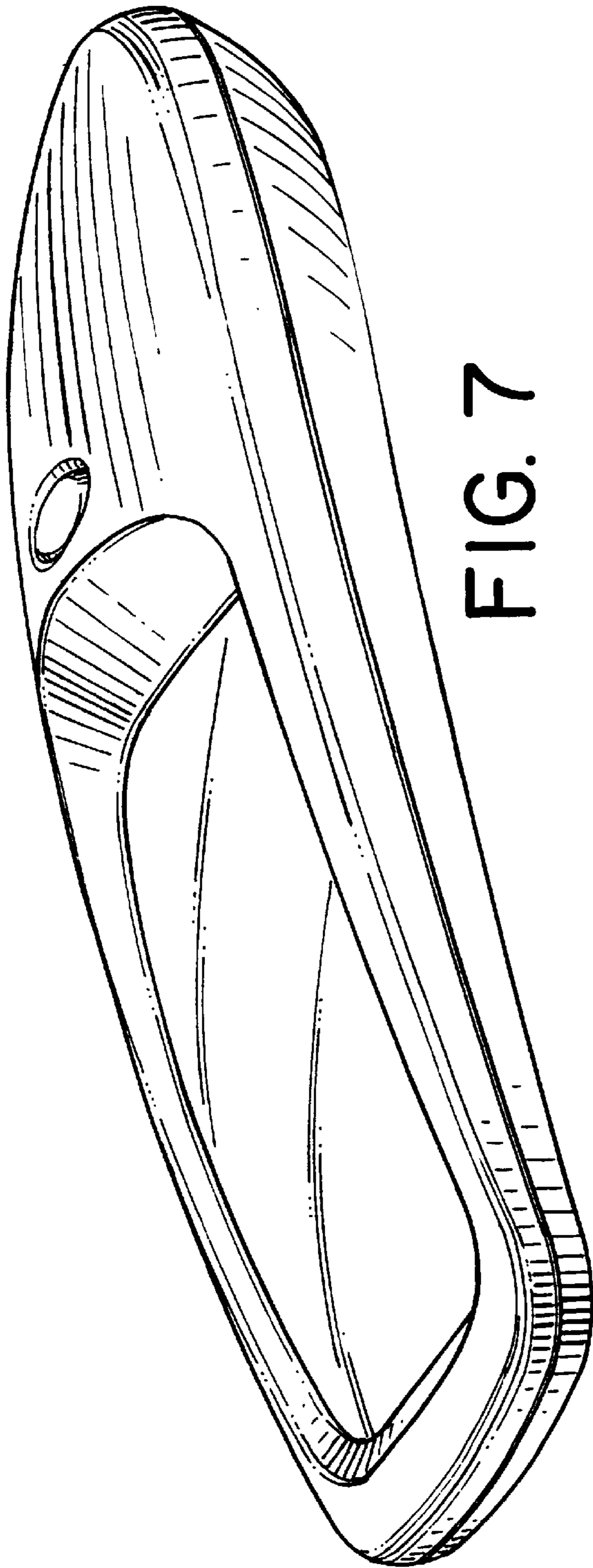
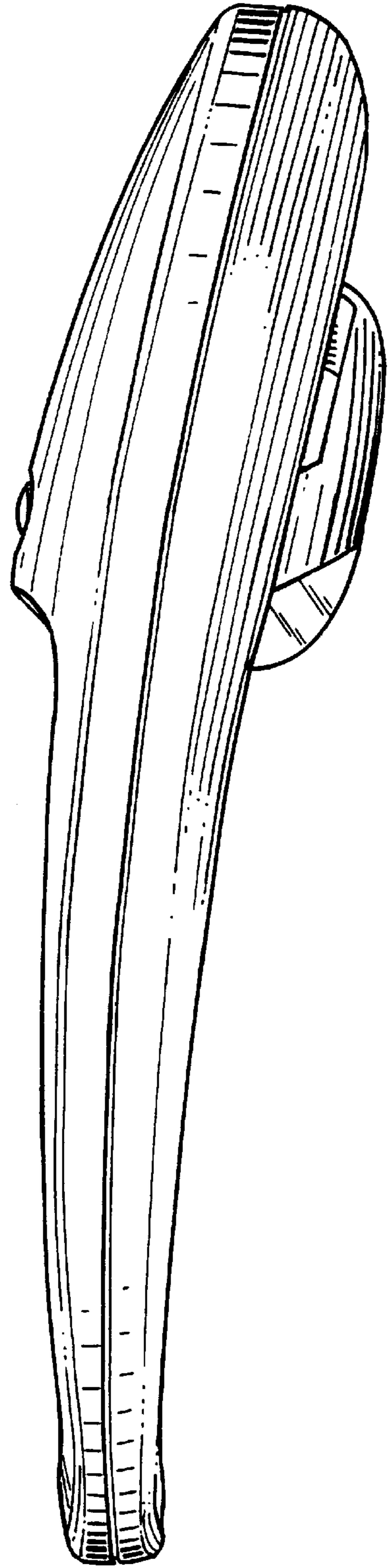

FIG. 7

FIG. 8





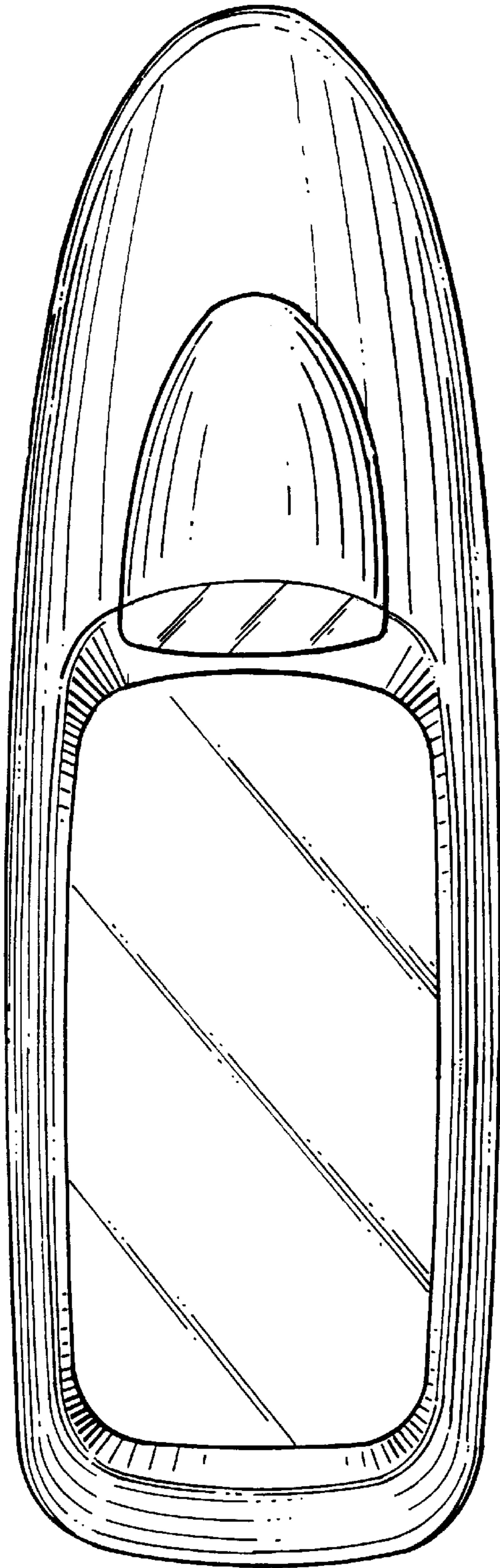

FIG. 10

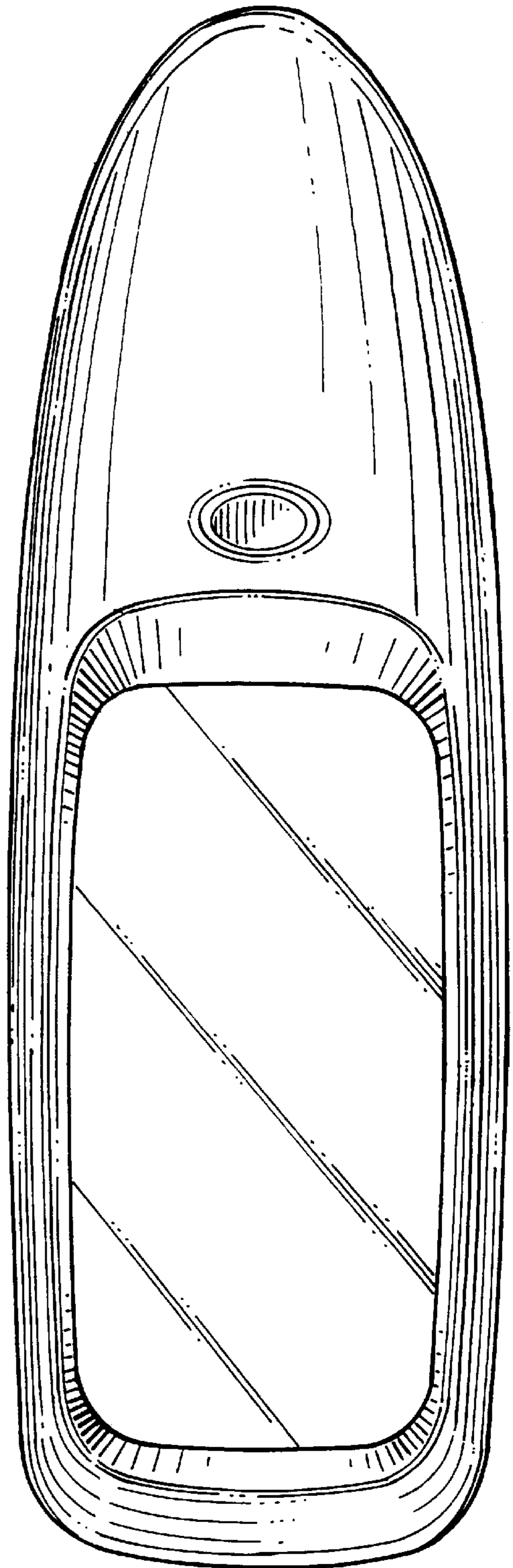

FIG. 9

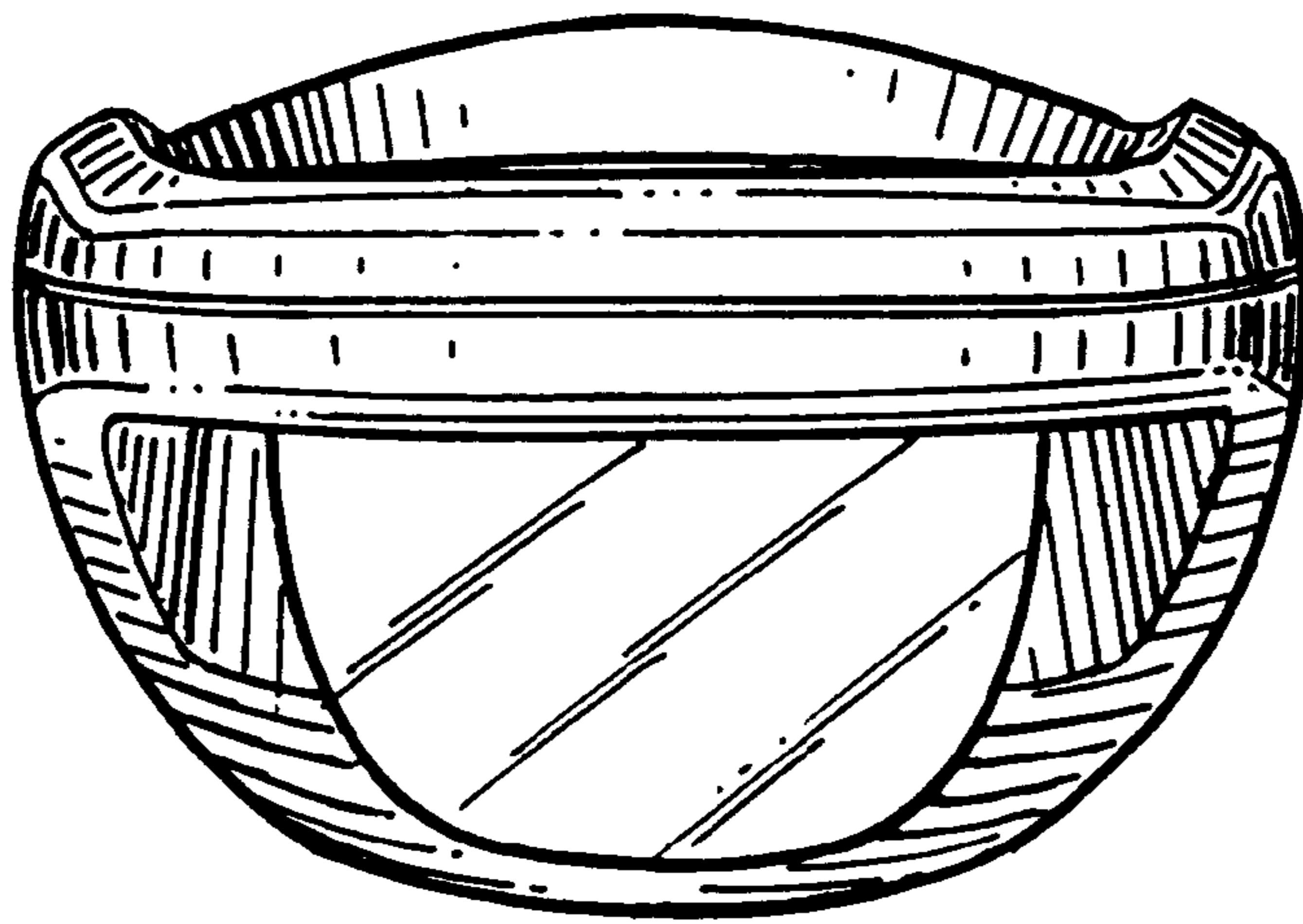

FIG. 11

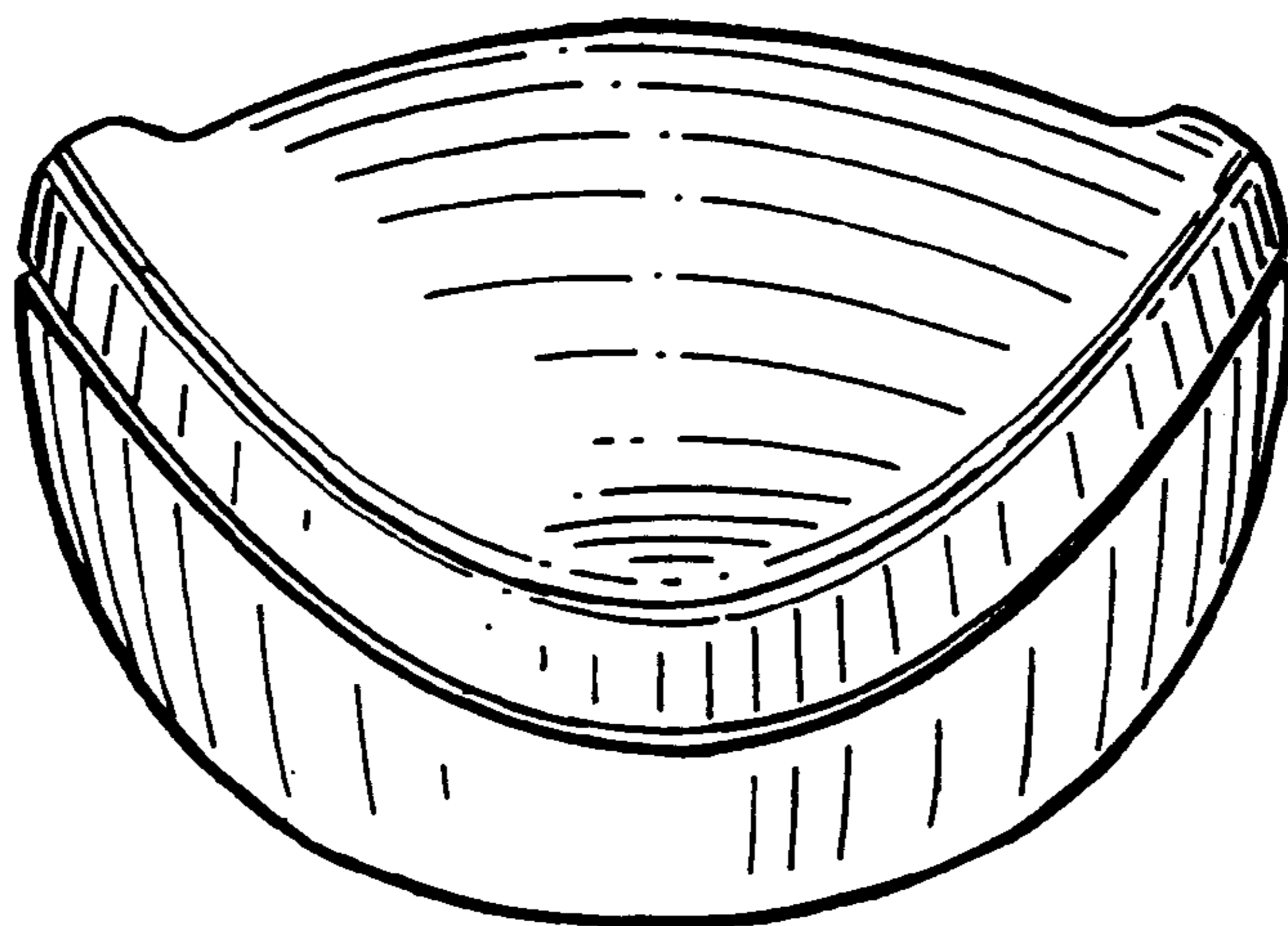

FIG. 12

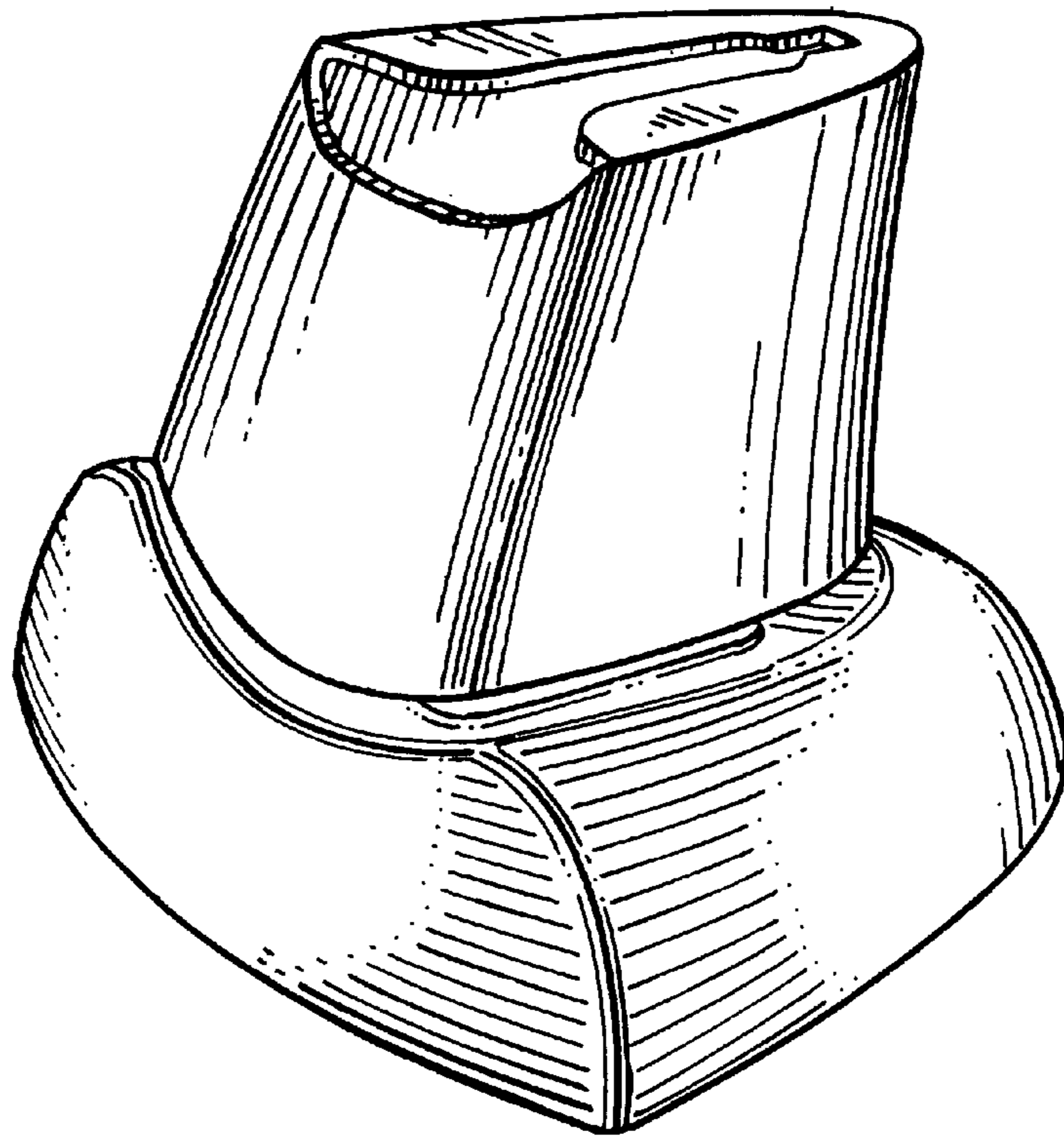

FIG. 13

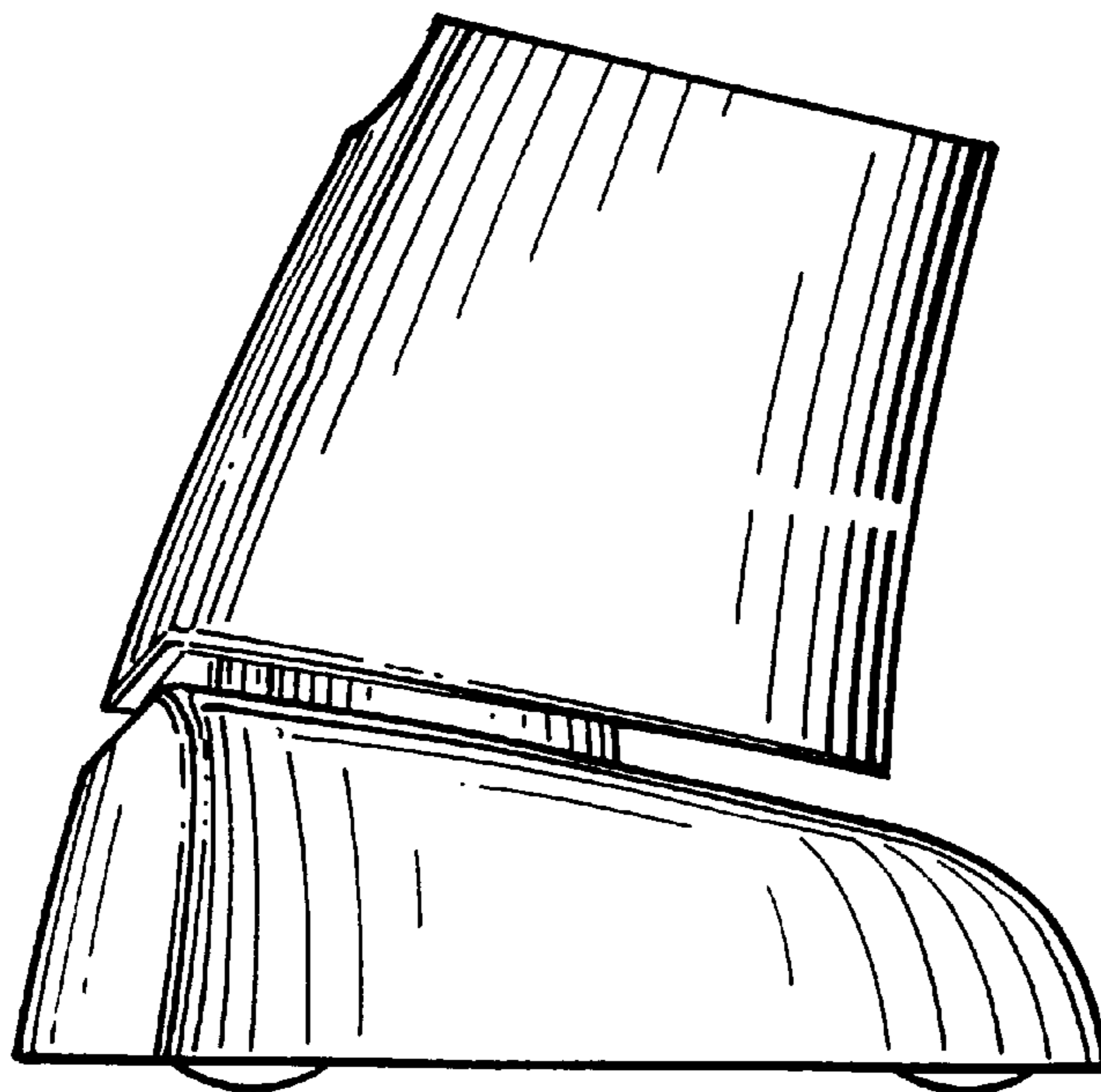

FIG. 14

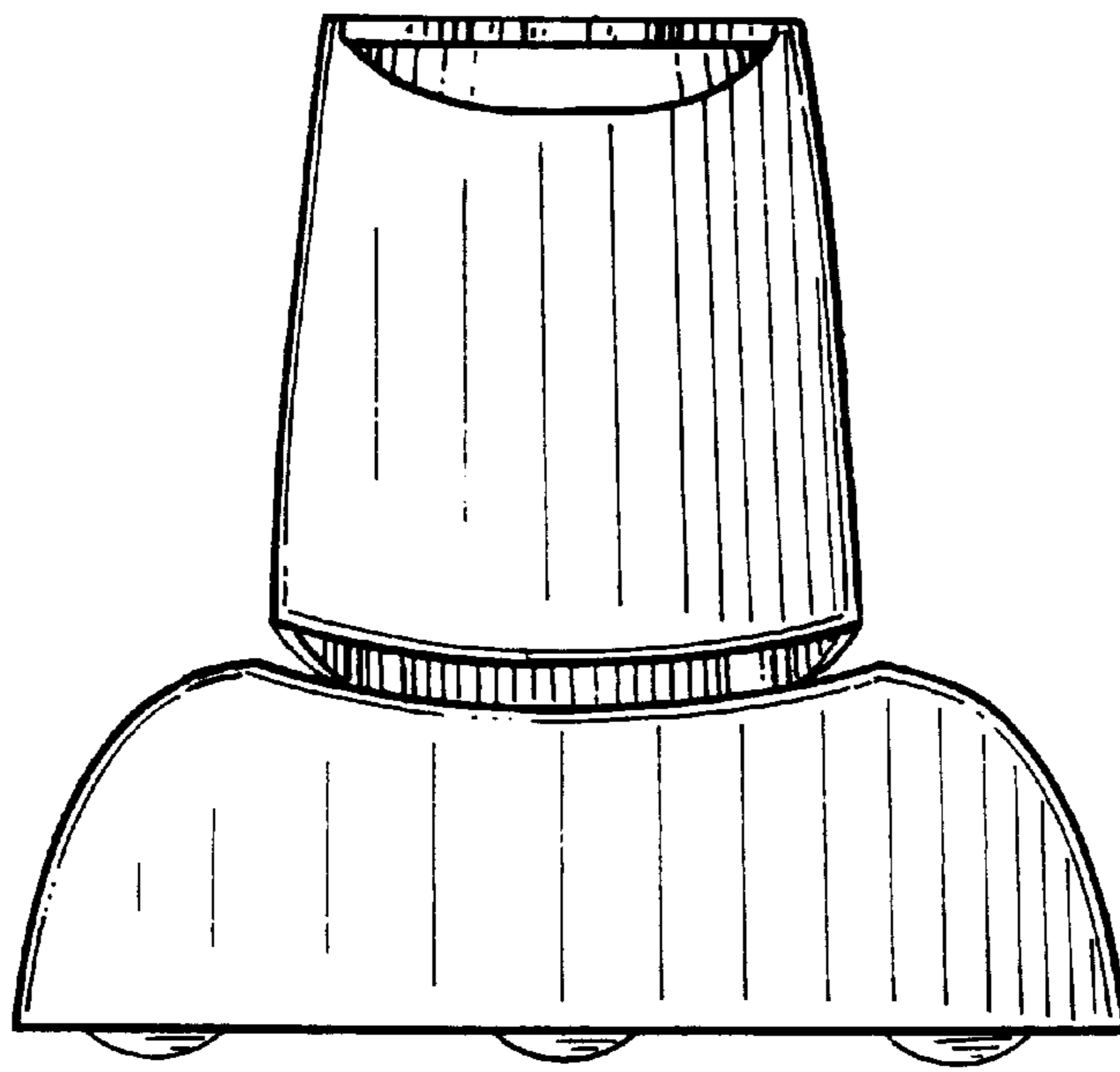

FIG. 15

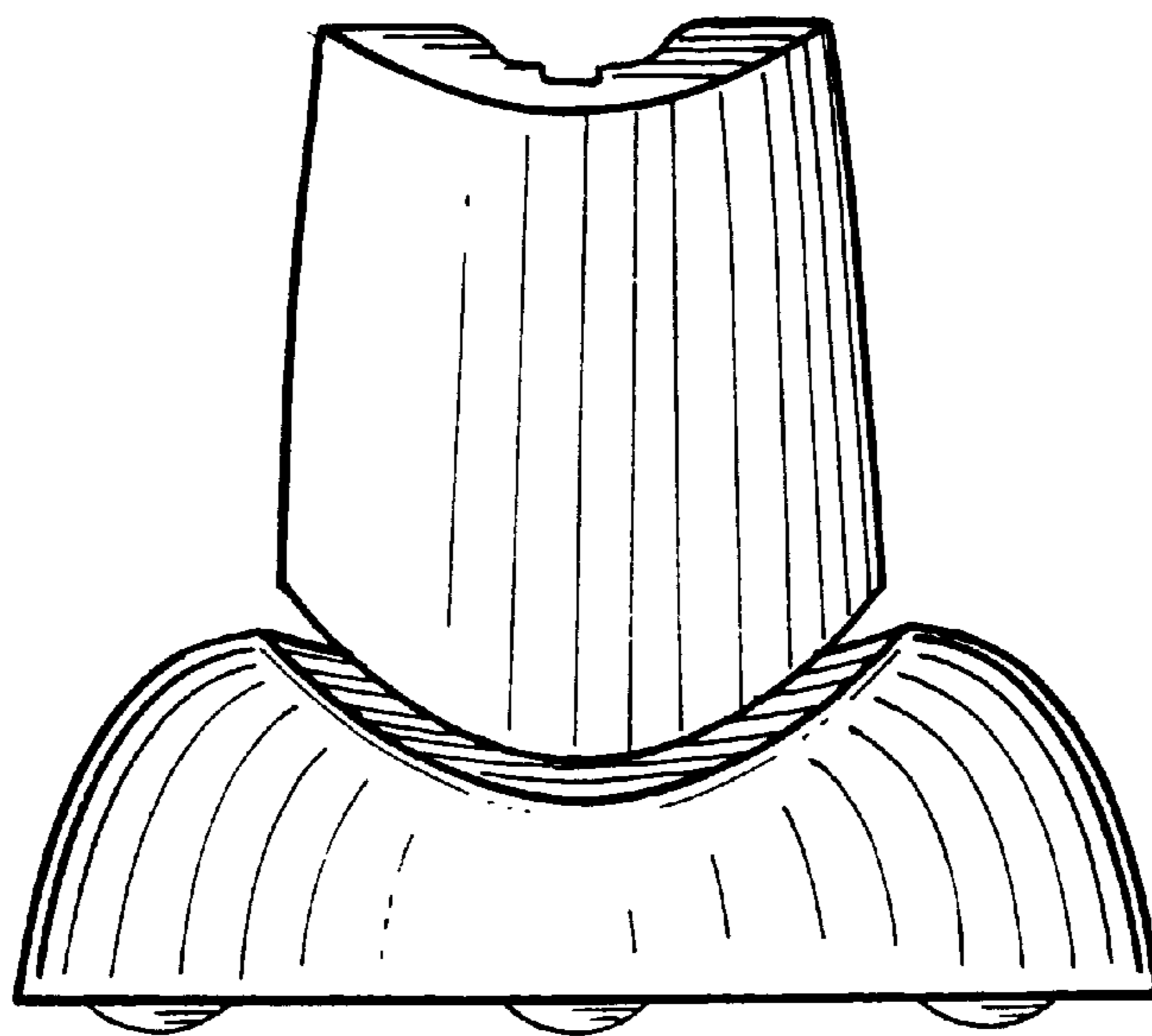

FIG. 16

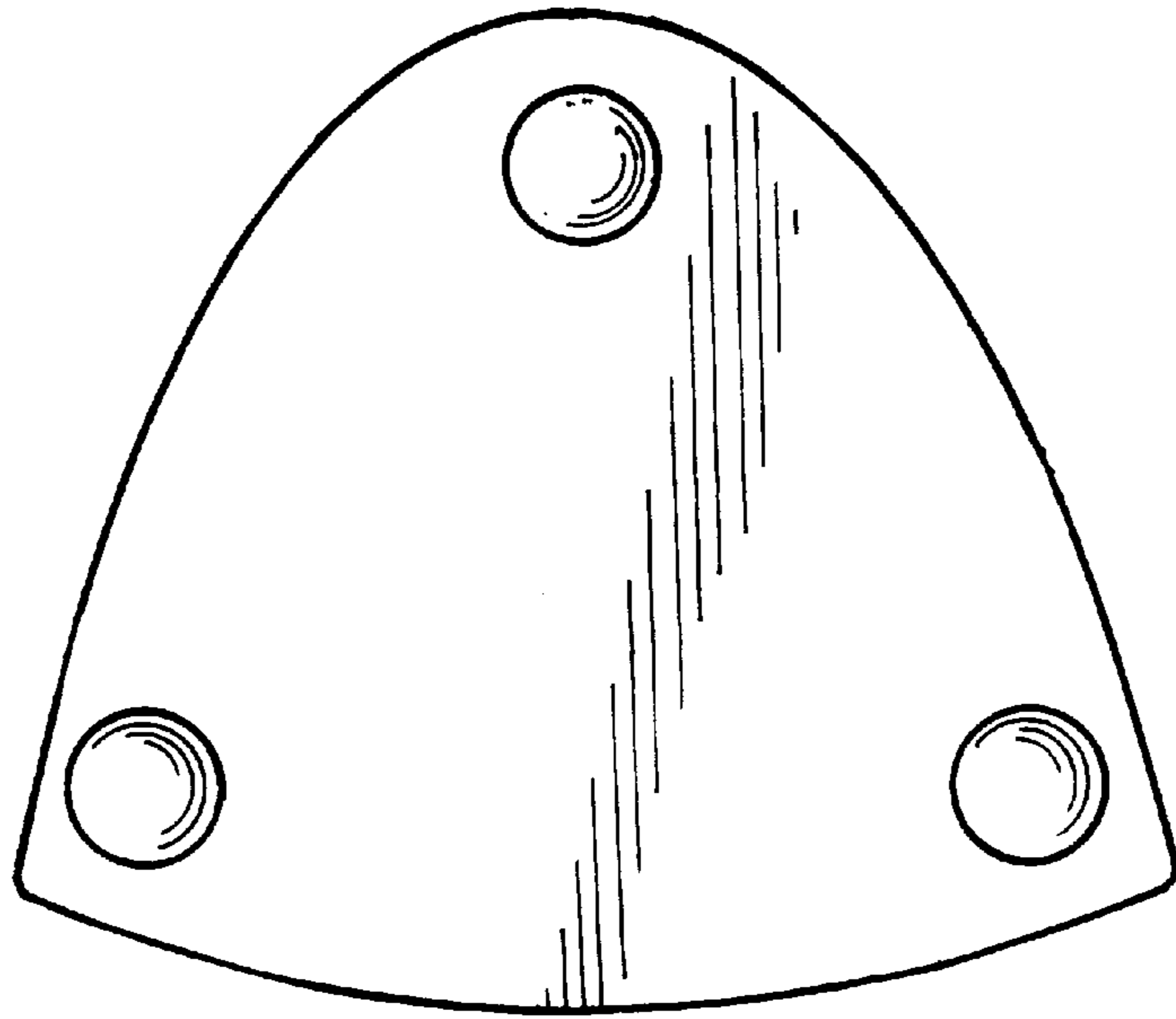

FIG. 18

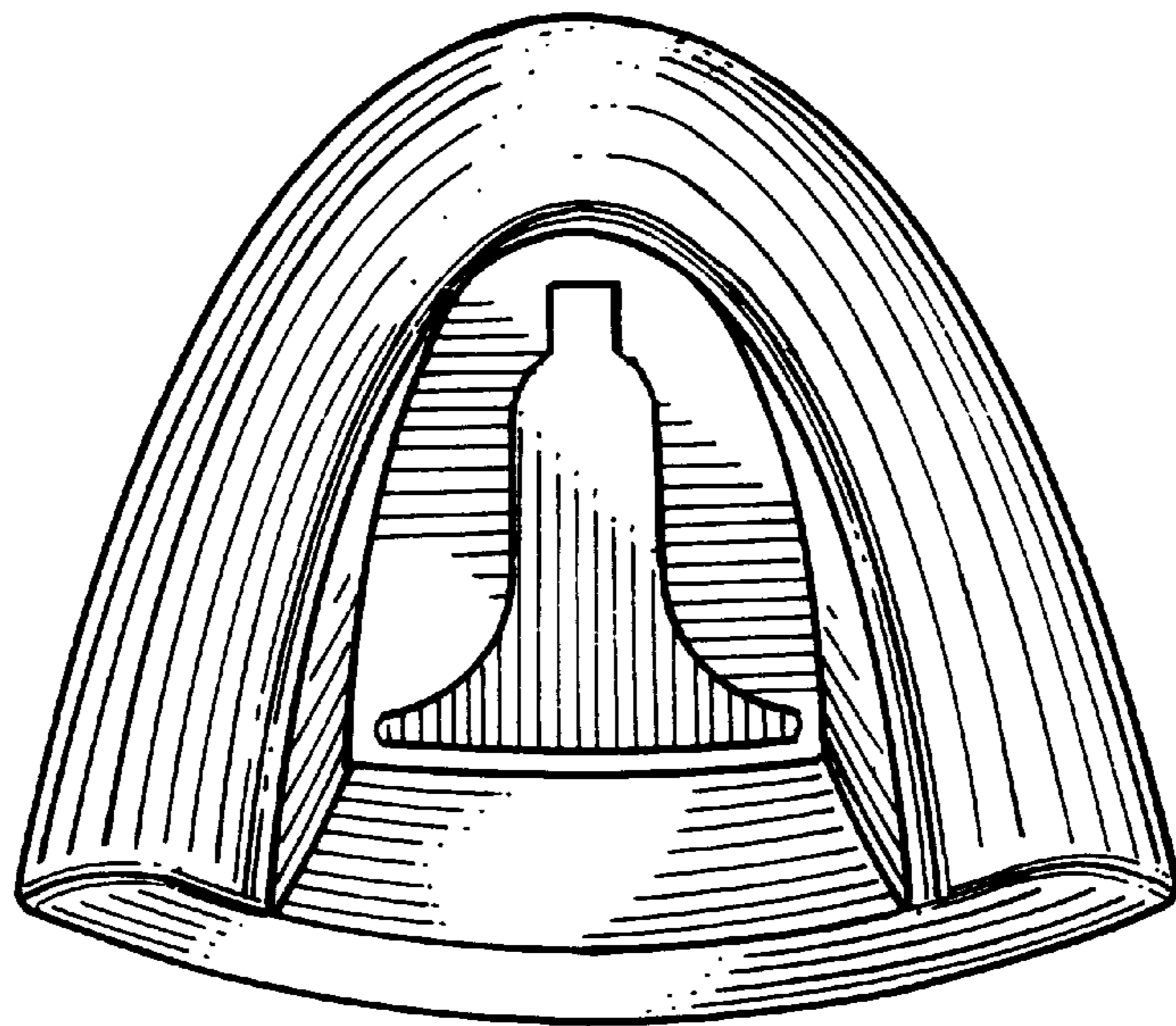

FIG. 17