



US00D424514S

# United States Patent [19]

Collins et al.

[11] Patent Number: **Des. 424,514**

[45] Date of Patent: **\*\* May 9, 2000**

[54] **BATTERY**

D. 406,097	2/1999	Lindahl	.....	D13/103
D. 406,560	3/1999	Lindahl	.....	D13/103
5,918,186	6/1999	Liu	.....	429/97 X

[75] Inventors: **Christopher T. Collins**, Cary, N.C.;  
**Dwight David Smith**, Lynchburg, Va.

[73] Assignee: **Ericsson Inc.**, Research Triangle Park,  
N.C.

[\*\*] Term: **14 Years**

*Primary Examiner*—Joel Sincavage  
*Attorney, Agent, or Firm*—Herbert V. Kerner

### [57] CLAIM

The ornamental design for a battery, as shown and described.

[21] Appl. No.: **29/111,053**

### DESCRIPTION

[22] Filed: **Sep. 17, 1999**

FIG. 1 is a front view of a battery for a telephone showing my new design;

[51] **LOC (7) Cl.** ..... **13-02**

FIG. 2 is a back view thereof;

[52] **U.S. Cl.** ..... **D13/103**

FIG. 3 is a side view thereof;

[58] **Field of Search** ..... D13/103, 119;  
429/96-100, 159, 163, 174

FIG. 4 is an opposite side view thereof;

FIG. 5 is a top view thereof;

FIG. 6 is a bottom view thereof;

### [56] References Cited

#### U.S. PATENT DOCUMENTS

D. 366,452	1/1996	Lindahl	.....	D13/103
D. 399,818	10/1998	Lindahl	.....	D13/103

FIG. 7 shows a front perspective view of a battery showing my design; and,

FIG. 8 shows a back perspective view thereof.

**1 Claim, 6 Drawing Sheets**

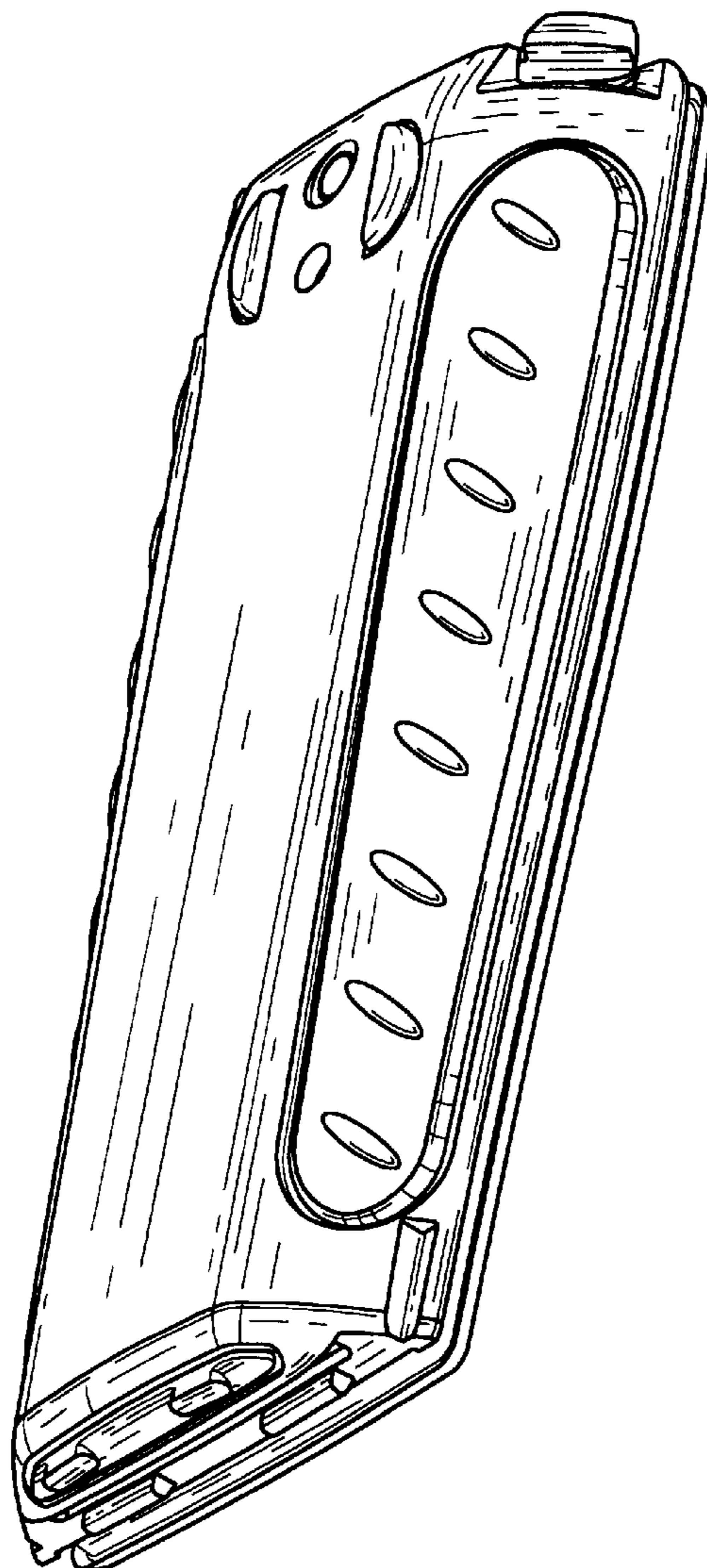

**FIG. 1**

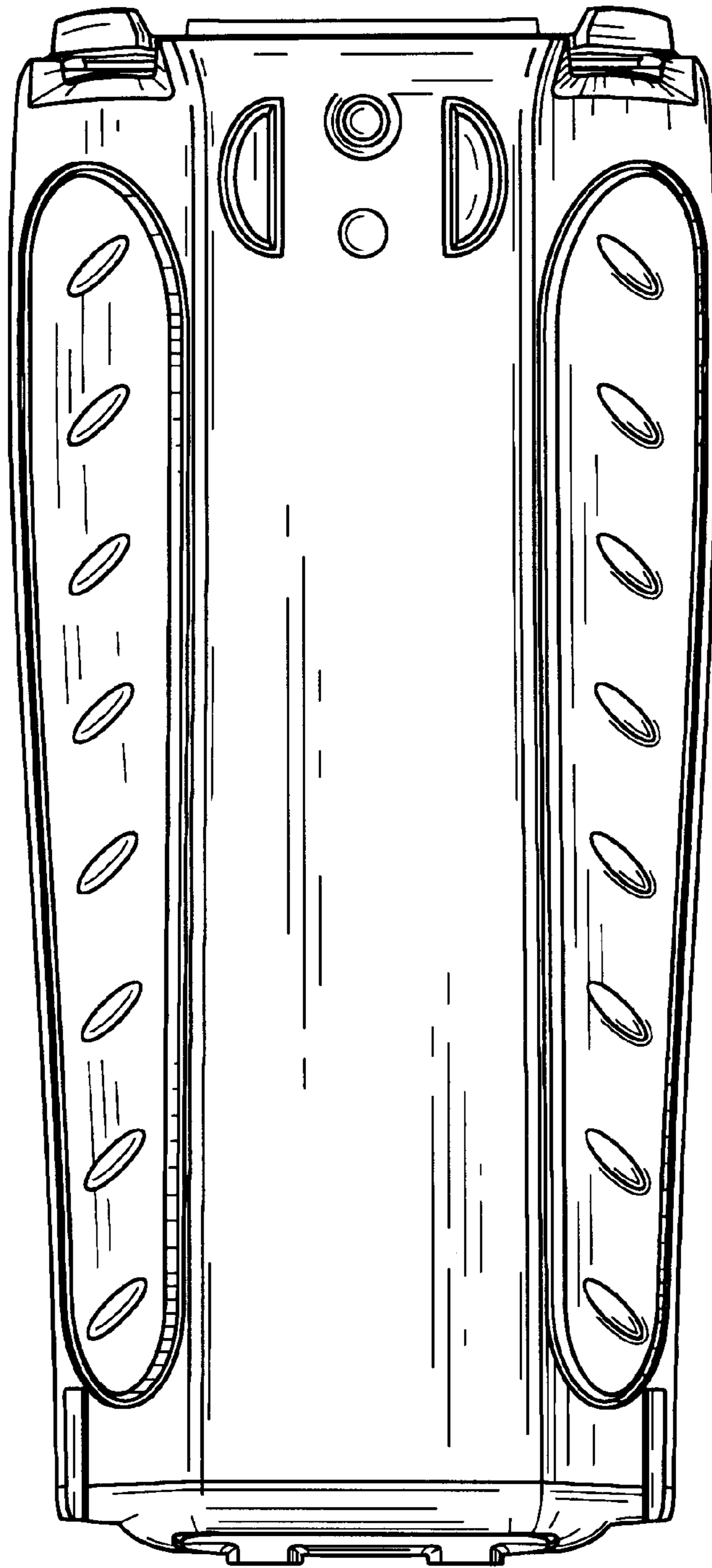

*FIG. 2*

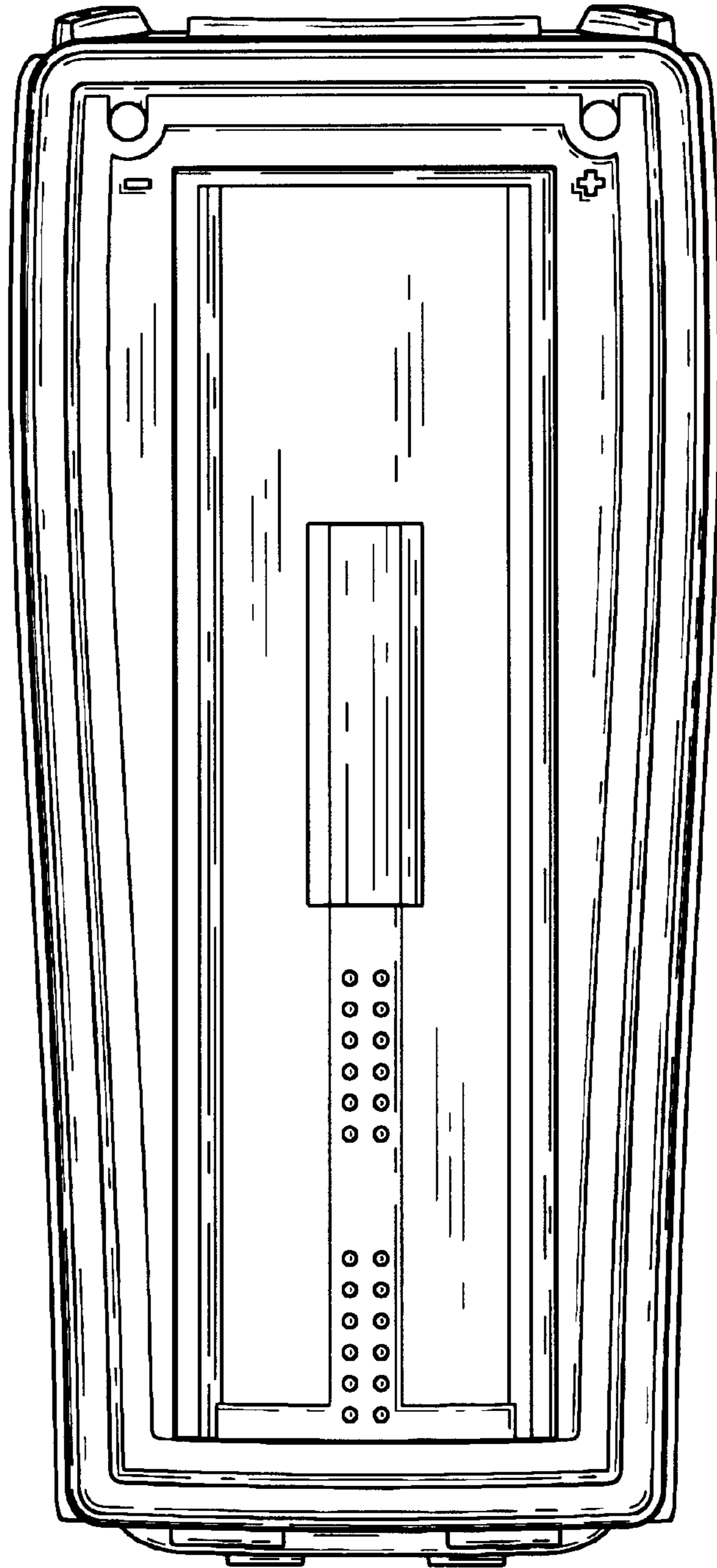

**FIG. 3**

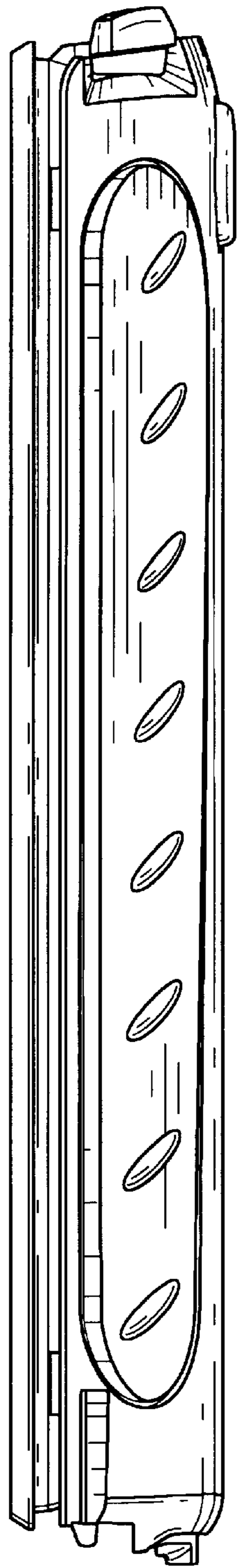

**FIG. 4**

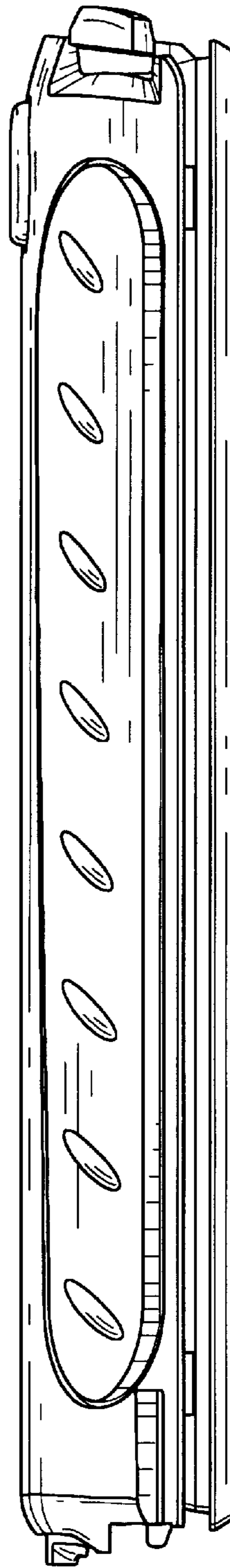

**FIG. 5**

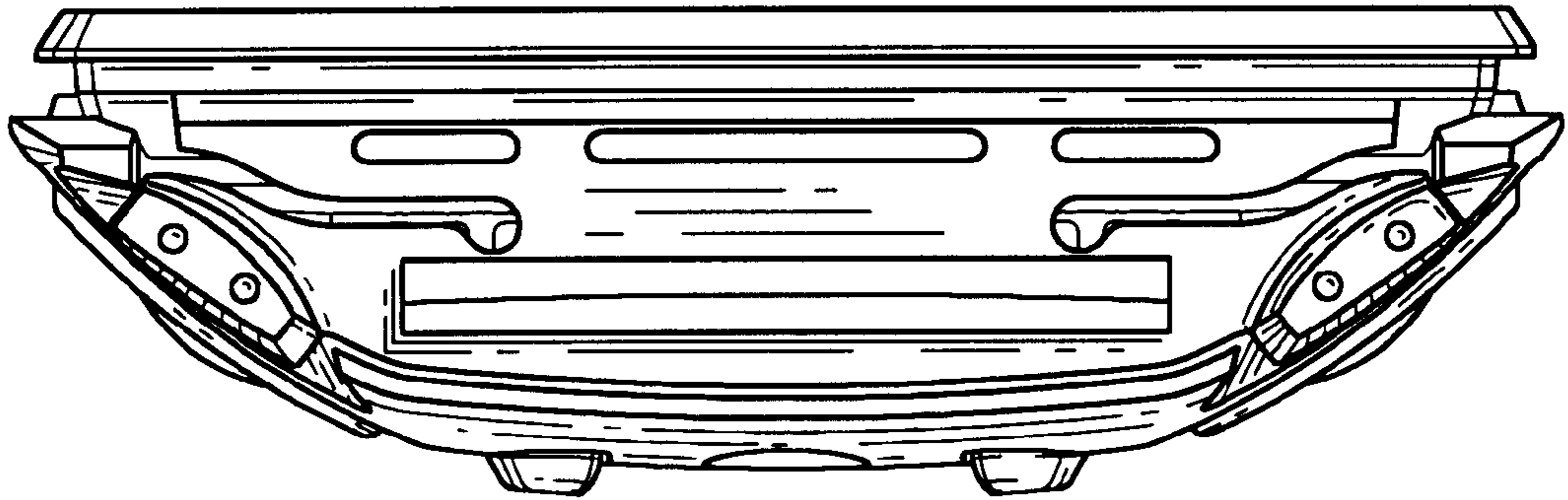

**FIG. 6**

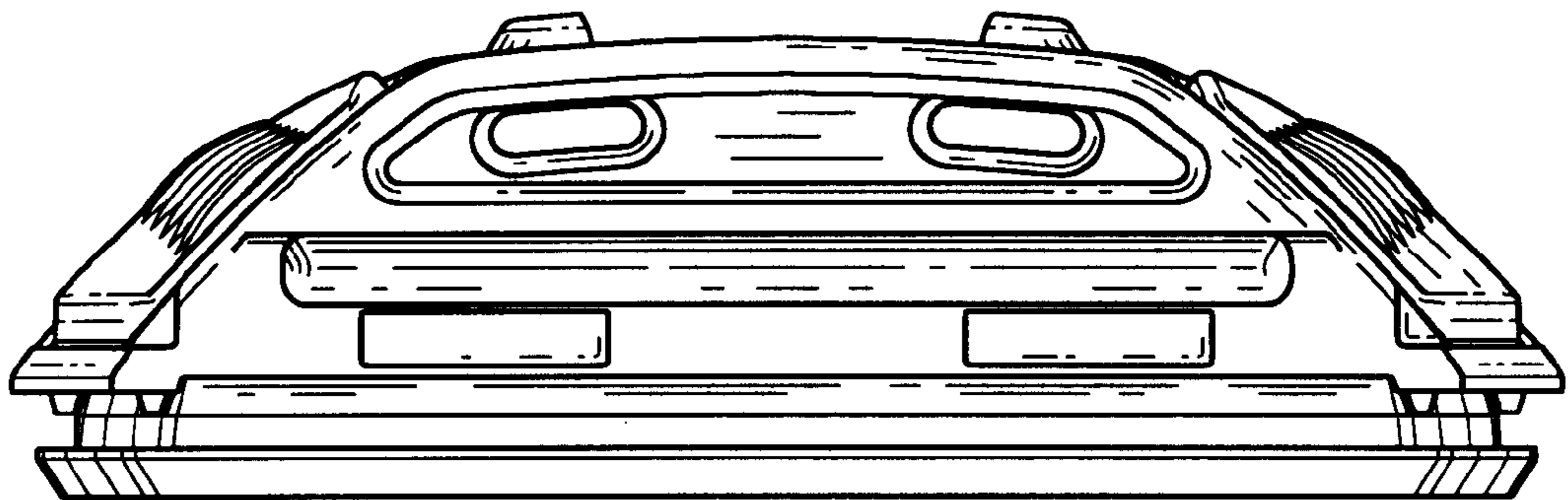

**FIG. 7**

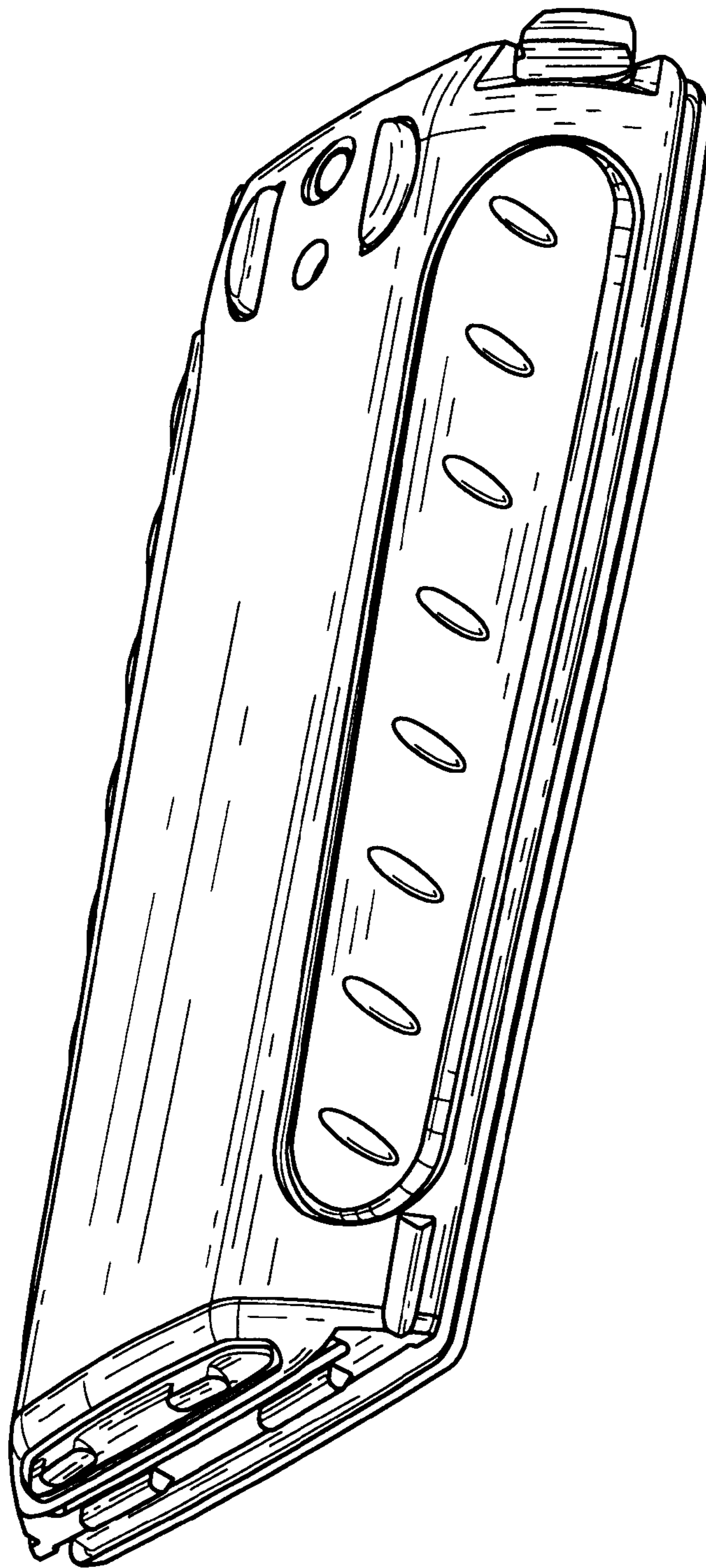

FIG. 8

