



US00D424373S

United States Patent [19]

[11] **Patent Number: Des. 424,373**

Aronson, II

[45] **Date of Patent: ** May 9, 2000**

[54] **IGNITER**

[75] Inventor: **Louis V. Aronson, II**, Oldwick, N.J.
[73] Assignee: **Ronson Corporation**, Woodbridge, N.J.
[**] Term: **14 Years**

[21] Appl. No.: **29/102,767**
[22] Filed: **Mar. 31, 1999**

[51] **LOC (7) Cl.** **07-99**
[52] **U.S. Cl.** **D7/416**
[58] **Field of Search** D7/416, 417; D27/154,
D27/131, 139; 131/329; 126/25 B, 409;
431/13, 344

[56] **References Cited**

U.S. PATENT DOCUMENTS

D. 327,813	7/1992	Shike et al.	D7/416
D. 379,415	5/1997	Mindle	D7/416
D. 390,750	2/1998	Sung	D7/416
D. 403,206	12/1998	Hsu	D7/416
D. 406,010	2/1999	Tubby et al.	D7/416
D. 410,363	6/1999	Tubby et al.	D7/416
D. 410,819	6/1999	Hsu	D7/416
5,865,614	2/1999	Hsu	431/344 X
5,934,289	8/1999	Watkins et al.	131/329 X

OTHER PUBLICATIONS

Ronson Catalog Sheet—Refillable & Reusable Varaflame Ignitor.

Primary Examiner—M. N. Pandozzi
Attorney, Agent, or Firm—Lerner, David, Littenberg, Krumholz & Mentlik, LLP

[57] **CLAIM**

The ornamental design for an igniter, as shown and described.

DESCRIPTION

FIG. 1 is a perspective view of an igniter showing my new design;
FIG. 2 is a rear elevational view;
FIG. 3 is a front elevational view;
FIG. 4 is a top plan view;
FIG. 5 is a bottom plan view;
FIG. 6 is a right side elevational view;
FIG. 7 is a left side elevational view;
FIG. 8 is a perspective view of a second embodiment of an igniter showing my new design.
FIG. 9 is a rear elevational view;
FIG. 10 is a front elevational view;
FIG. 11 is a top plan view;
FIG. 12 is a bottom plan view;
FIG. 13 is a right side elevational view;
FIG. 14 is a left side elevational view;
FIG. 15 is a perspective view of a third embodiment of an igniter showing my new design.
FIG. 16 is a rear elevational view;
FIG. 17 is a front elevational view;
FIG. 18 is a top plan view;
FIG. 19 is a bottom plan view;
FIG. 20 is a right side elevational view; and,
FIG. 21 is a left side elevational view.

The broken lines shown in the drawings are for illustration purpose only and form no part of the claimed design.

1 Claim, 6 Drawing Sheets

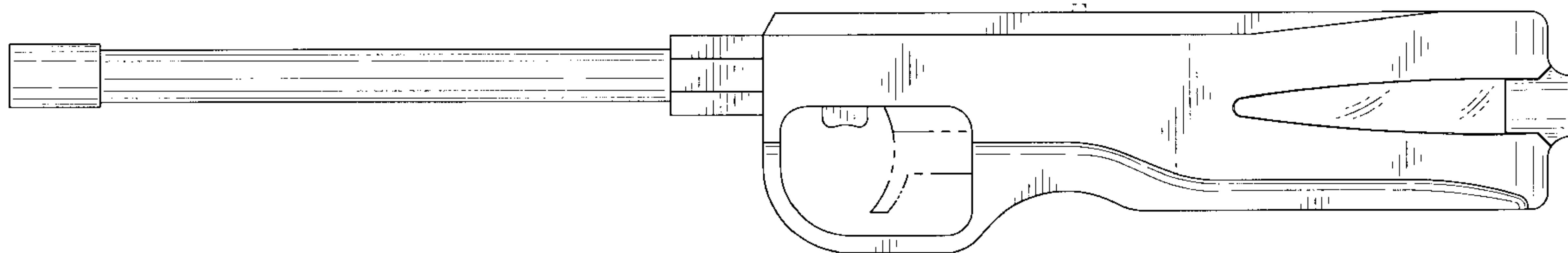

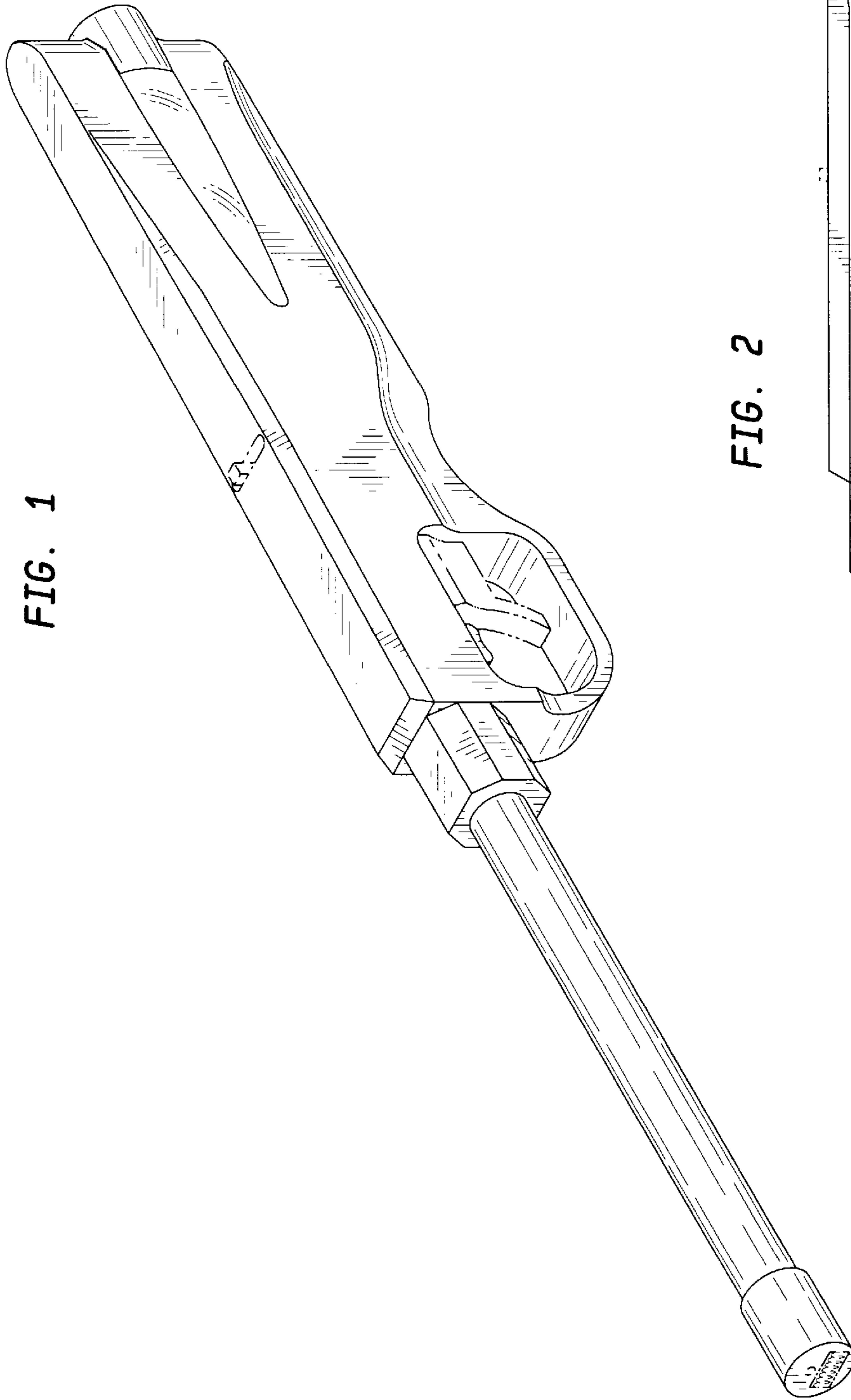

FIG. 1

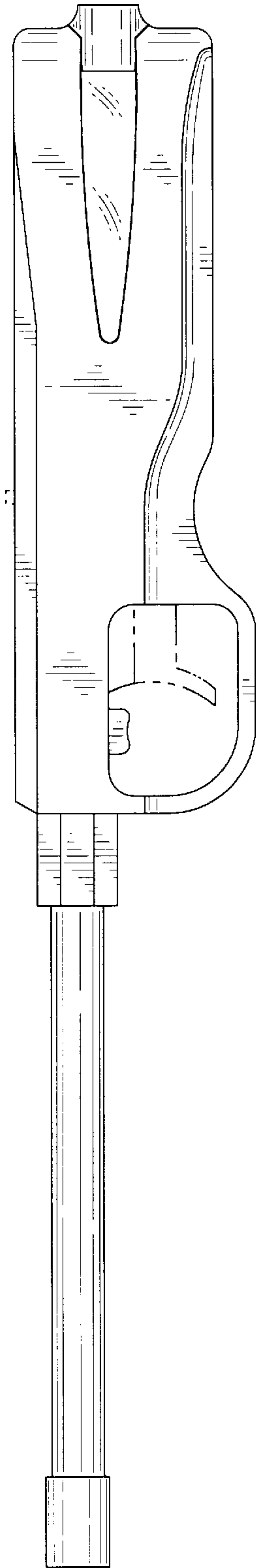

FIG. 2

FIG. 3

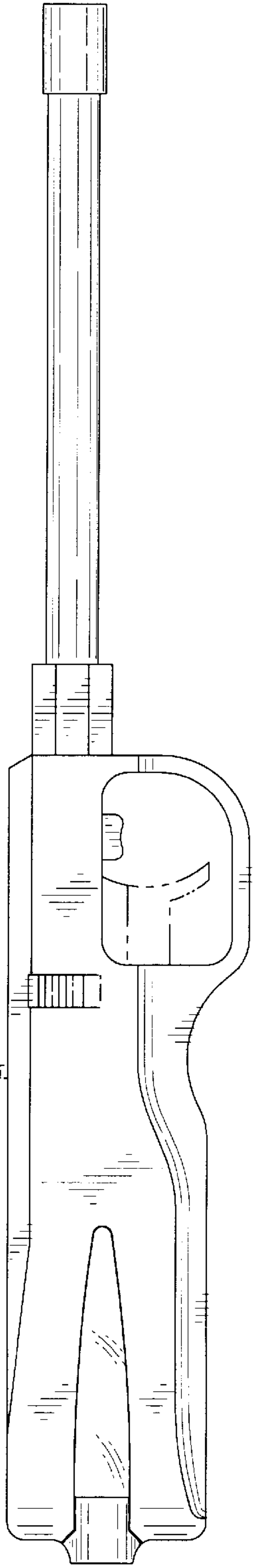

FIG. 4

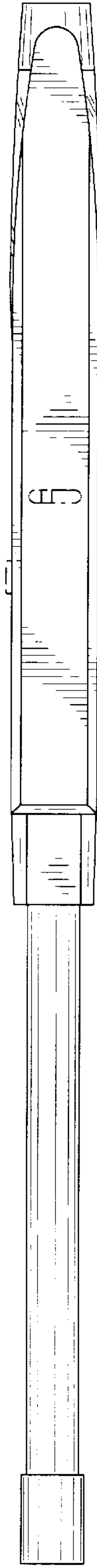

FIG. 5

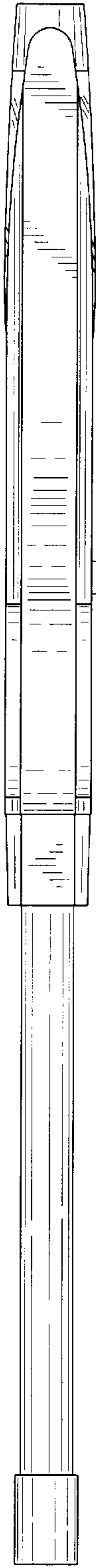

FIG. 6

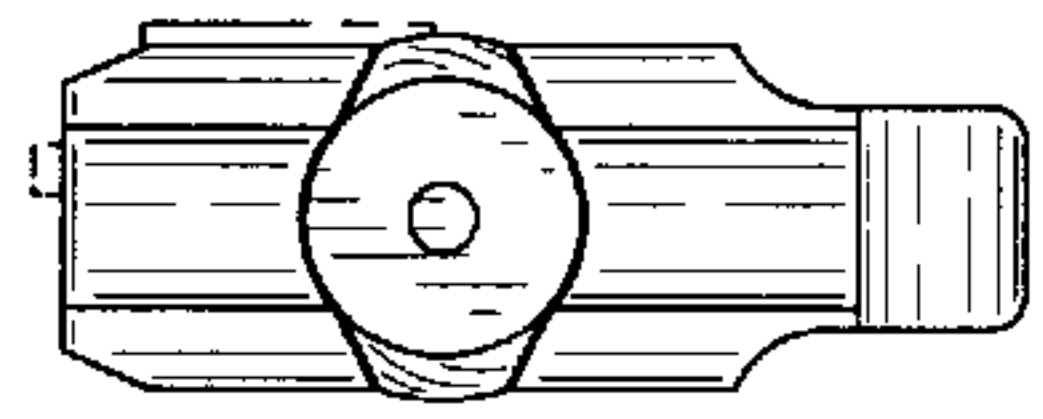
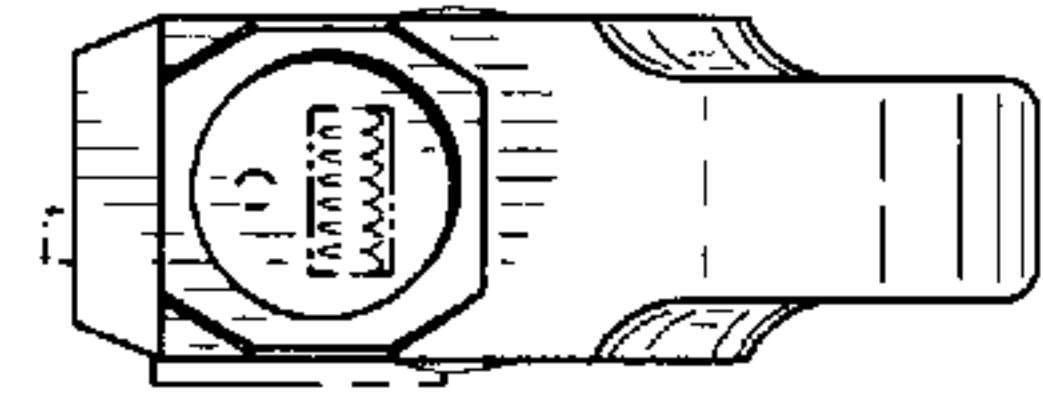

FIG. 7



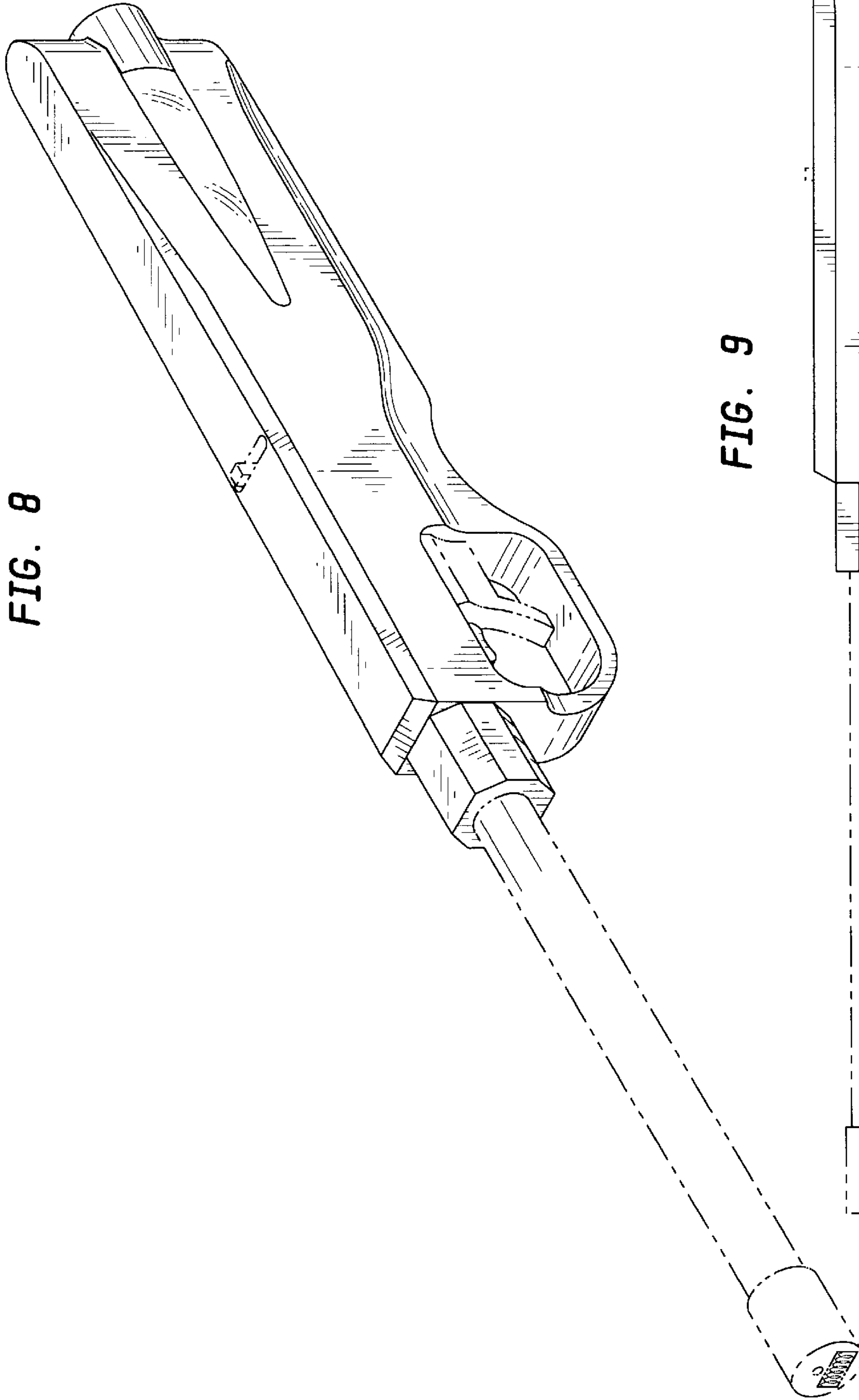

FIG. 9

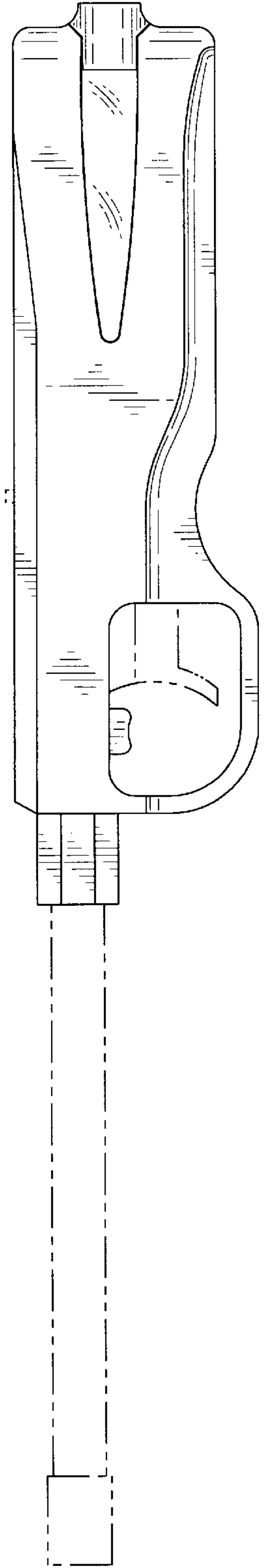

FIG. 10

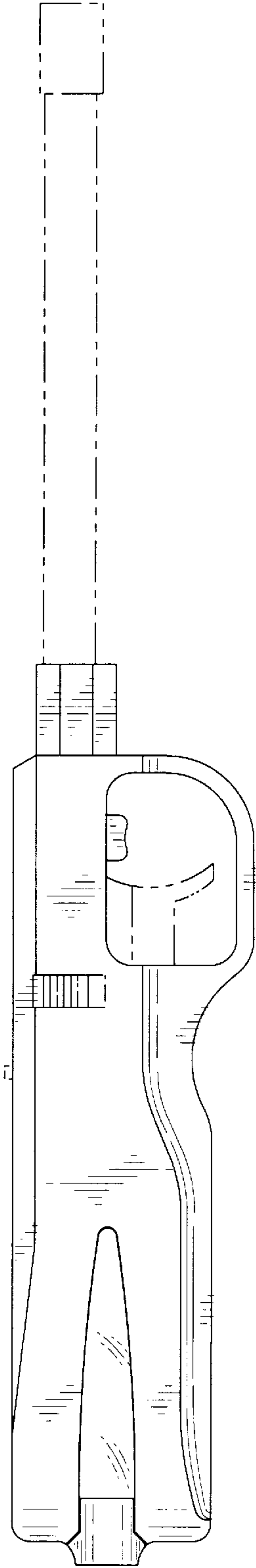

FIG. 11

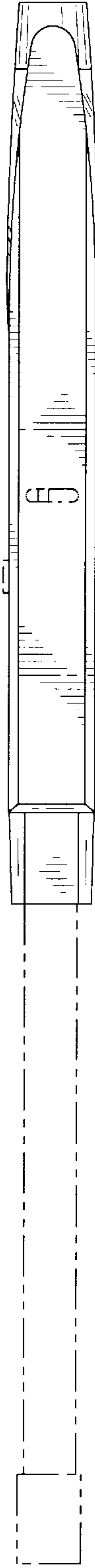

FIG. 12

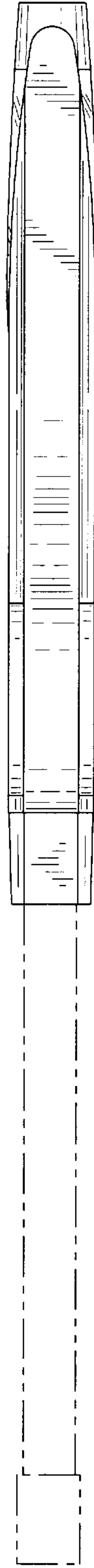

FIG. 13

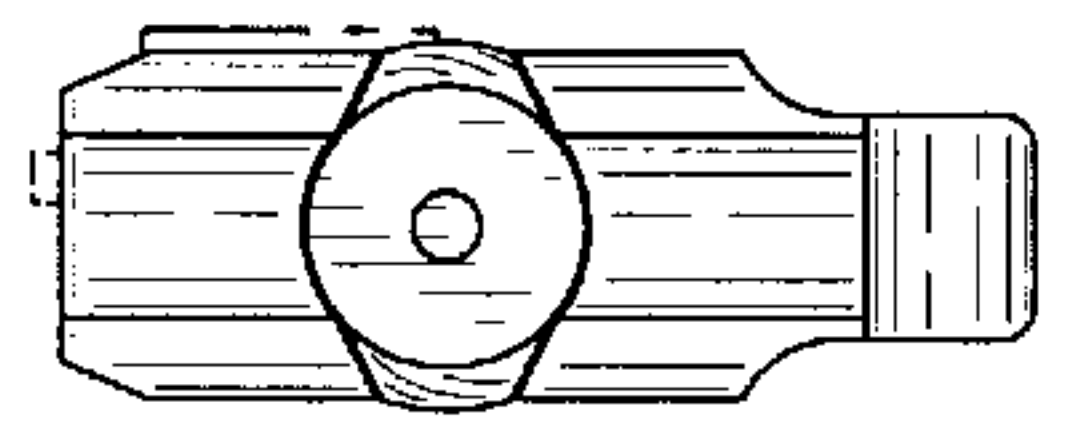

FIG. 14

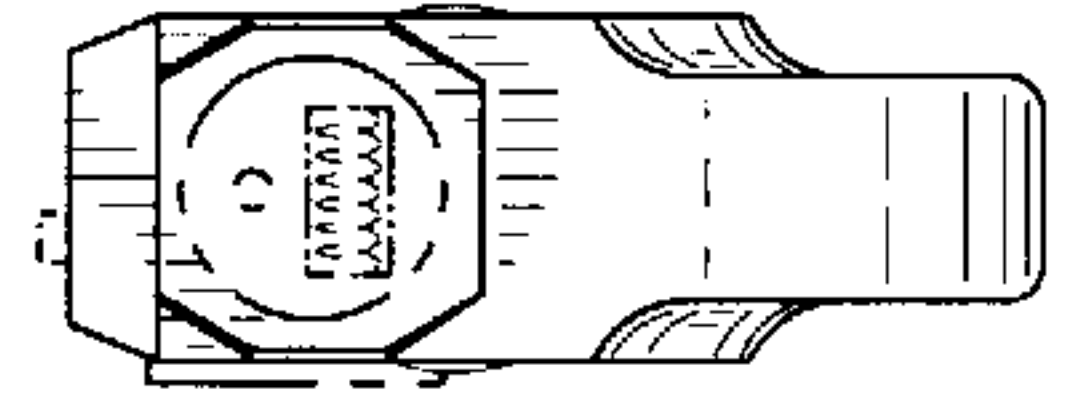

FIG. 15

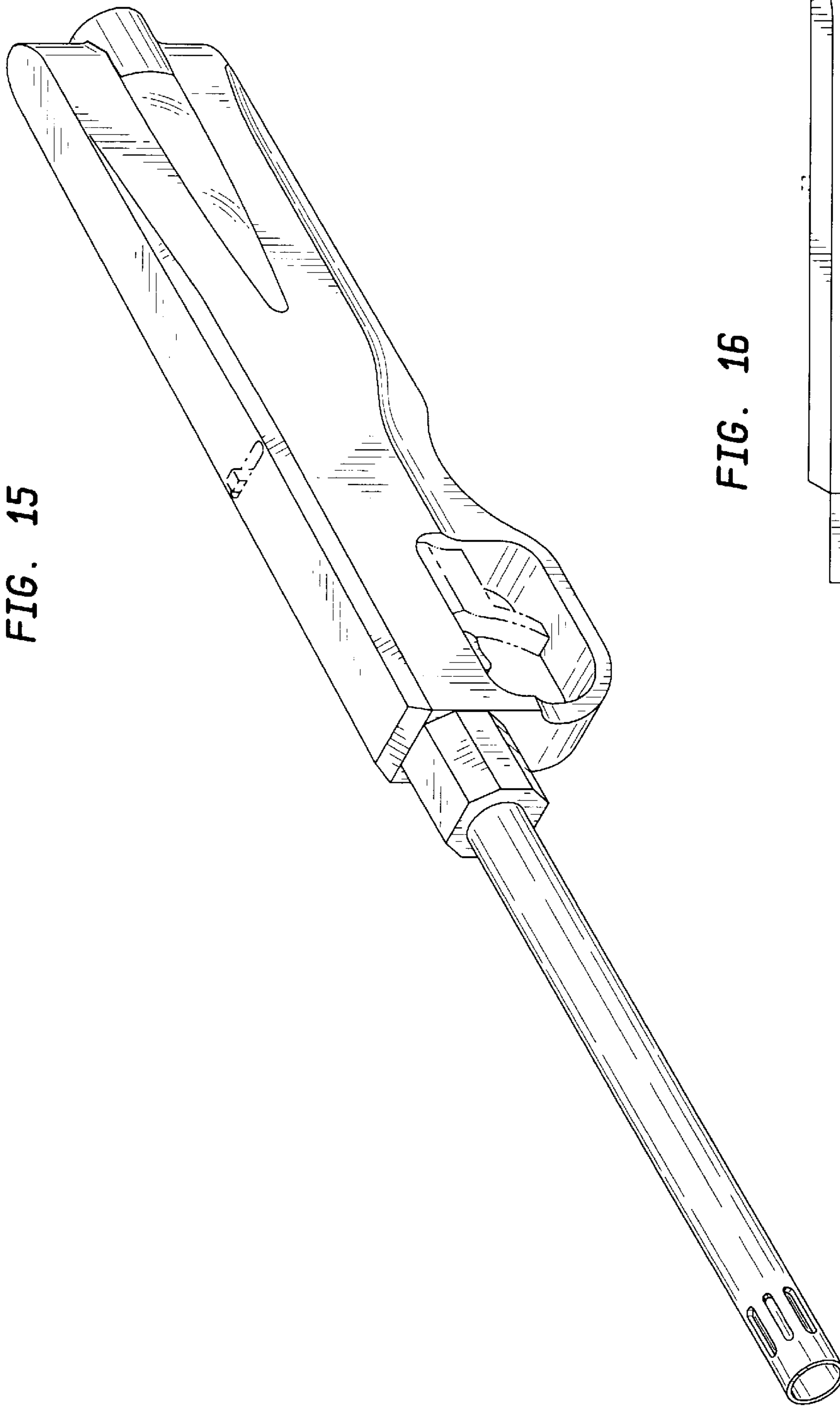

FIG. 16

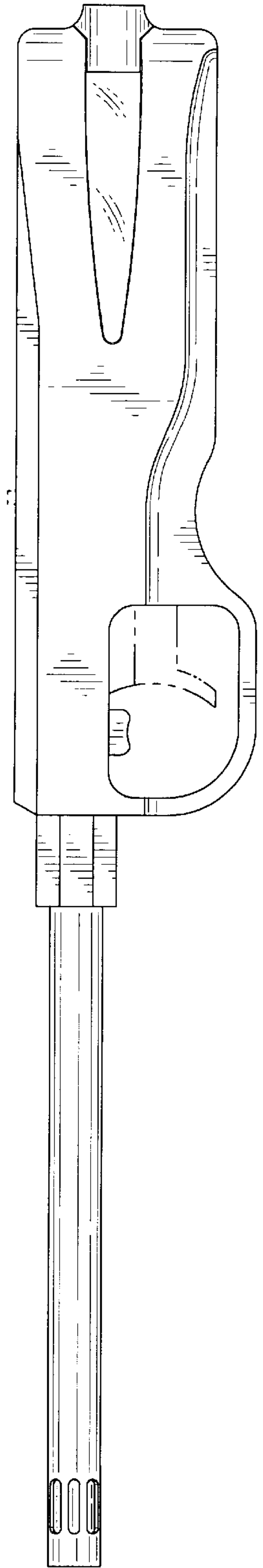

FIG. 17

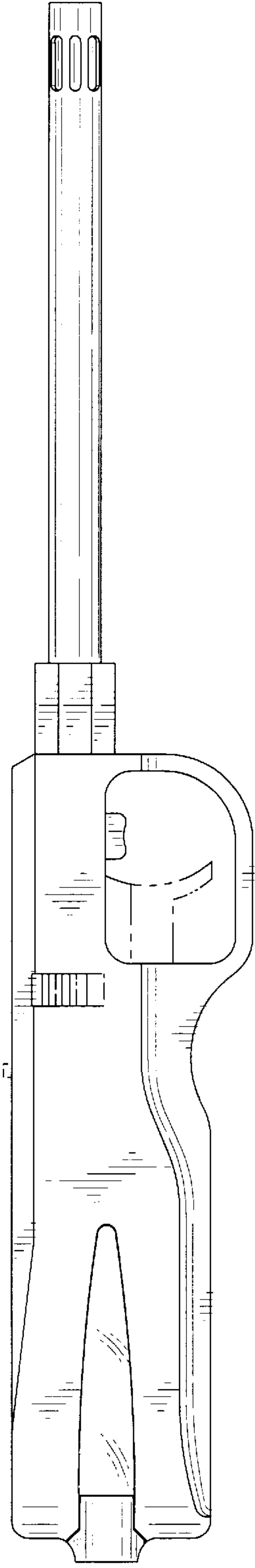

FIG. 18

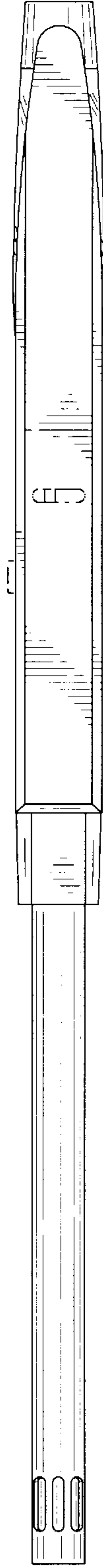

FIG. 19

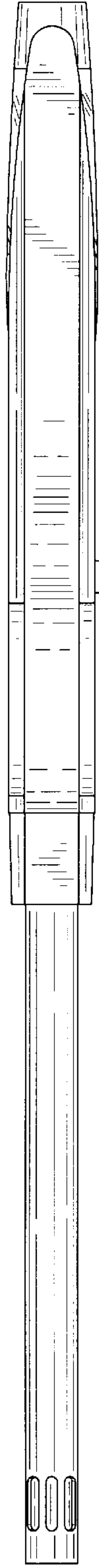

FIG. 21

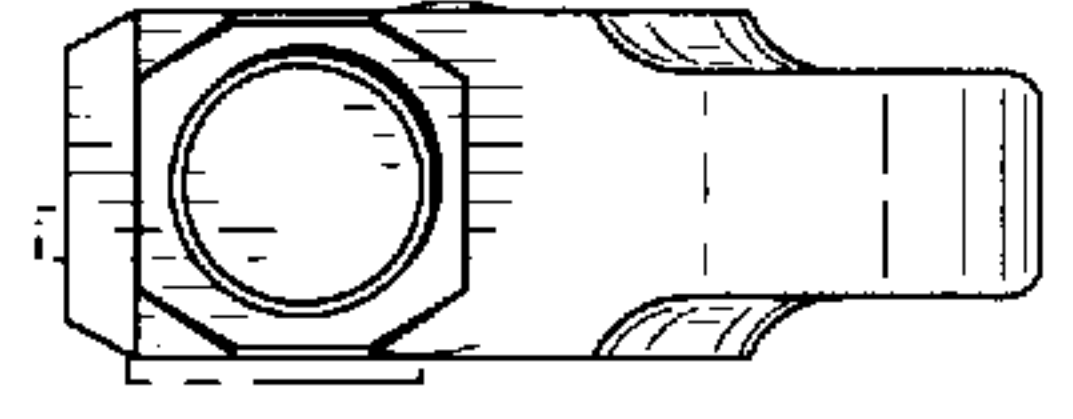

FIG. 20

