



US00D424318S

United States Patent [19]

[11] **Patent Number: Des. 424,318**

Natuzzi et al.

[45] **Date of Patent: ** May 9, 2000**

[54] **SEAT**

[75] Inventors: **Pasquale Natuzzi; Raffaella Lucarelli,**
both of Bari, Italy

[73] Assignee: **Industrie Natuzzi Spa,** Bari, Italy

[**] Term: **14 Years**

[21] Appl. No.: **29/103,942**

[22] Filed: **Apr. 23, 1999**

[51] **LOC (7) Cl. 06-01**

[52] **U.S. Cl. D6/381; D6/334**

[58] **Field of Search D6/334, 335, 336,**
D6/364, 371, 373, 381, 500, 501, 502;
5/12.1; 297/232, 445.1, 446.1

[56] **References Cited**

U.S. PATENT DOCUMENTS

D. 343,742	2/1994	Gera	D6/381
D. 369,480	5/1996	Natuzzi et al.	D6/381
D. 374,355	10/1996	Natuzzi et al.	D6/381
D. 381,221	7/1997	Natuzzi et al.	D6/381
D. 382,130	8/1997	Natuzzi et al.	D6/381
D. 385,426	10/1997	Gibson	D6/381
D. 387,575	12/1997	Natuzzi et al.	D6/381
D. 393,957	5/1998	Natuzzi et al.	D6/381
D. 400,368	11/1998	Natuzzi et al.	D6/381
D. 407,572	4/1999	Natuzzi et al.	D6/381
D. 407,573	4/1999	Natuzzi et al.	D6/381

OTHER PUBLICATIONS

Natuzzi Model 487, Apr. 1989, at International Home Furnishings Market in High Point, North Carolina.

Natuzzi Model 488, Apr. 1989, at International Home Furnishings Market in High Point, North Carolina.

Natuzzi Model 619, Oct. 1988, at International Home Furnishings Market in High Point, North Carolina.

Natuzzi Model 756, Apr. 1990, at International Home Furnishings Market in High Point, North Carolina.

Natuzzi Model 800, Oct. 1990, at International Home Furnishings Market in High Point, North Carolina.

Natuzzi Model 920, Apr. 1992, at International Home Furnishings Market in High Point, North Carolina.

Natuzzi Model 925, Apr. 1992, at International Home Furnishings Market in High Point, North Carolina.

Natuzzi Model 926, Apr. 1992, at International Home Furnishings Market in High Point, North Carolina.

Natuzzi Model 940, Apr. 1992, at International Home Furnishings in High Point, North Carolina.

Natuzzi Model 1068, Sep. 1993, at International Home Furnishings Market in High Point, North Carolina.

Natuzzi Model 1100, Oct. 1993, at International Home Furnishings Market in High Point, North Carolina.

Natuzzi Model 1156, Apr. 1994, at International Home Furnishings Market in High Point, North Carolina.

Natuzzi Model 1169, Apr. 1994 at International Home Furnishings Market in High Point, North Carolina.

Natuzzi Model 1207, Oct. 1994, at International Home Furnishings Market in High Point, North Carolina.

Natuzzi Model 1297, Mar. 1995, at International Home Furnishings Market in High Point, North Carolina.

Natuzzi Model 1325, Sep. 1995, at International Home Furnishings Market in High Point, North Carolina.

Natuzzi Model 1597, Apr. 1997, at International Home Furnishings Market in High Point, North Carolina.

Natuzzi Model 1634, Oct 1997, at International Home Furnishings Market in High Point, North Carolina.

Primary Examiner—Gary D. Watson

Attorney, Agent, or Firm—Alston & Bird LLP

[57] **CLAIM**

The ornamental design for a seat, as shown and described.

DESCRIPTION

FIG. 1 is a front perspective view of a seat showing our new design in the form of a sofa;

FIG. 2 is a front elevational view thereof;

FIG. 3 is a top plan view thereof;

FIG. 4 is a right side elevational view, the left side being a mirror image thereof;

FIG. 5 is a rear perspective view thereof;

FIG. 6 is a front elevational view of a seat showing our new design in the form of a loveseat; and,

FIG. 7 is a front elevational view of a seat showing our new design in the form of a chair.

The broken lines shown herein are for illustrative purposes only and form no part of the claimed design.

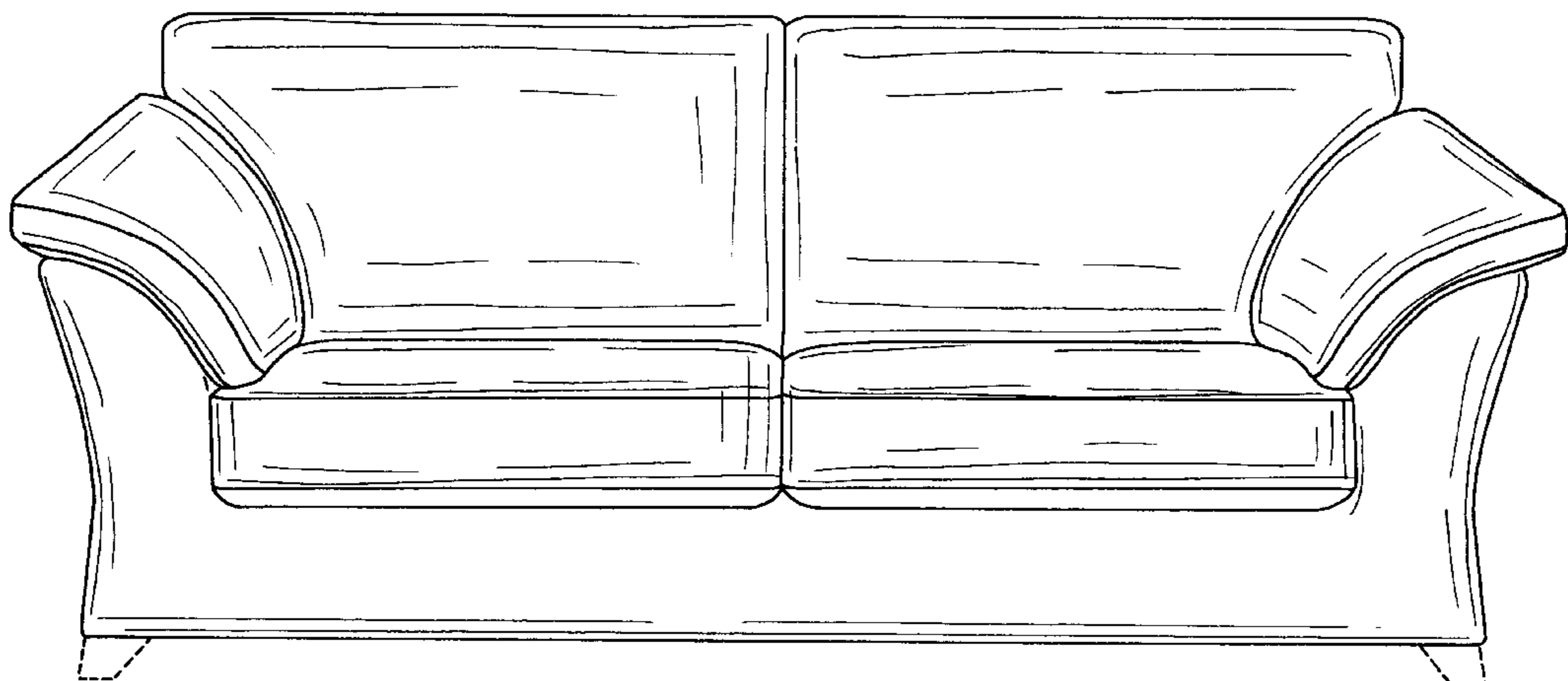

The rear views of FIGS. 6 and 7 are like FIG. 5, the difference being a matter of length.
The end views of FIGS. 6 and 7 are like that shown in FIG. 4.

FIG. 1 is shown on an enlarged scale relative to the other views.

1 Claim, 3 Drawing Sheets

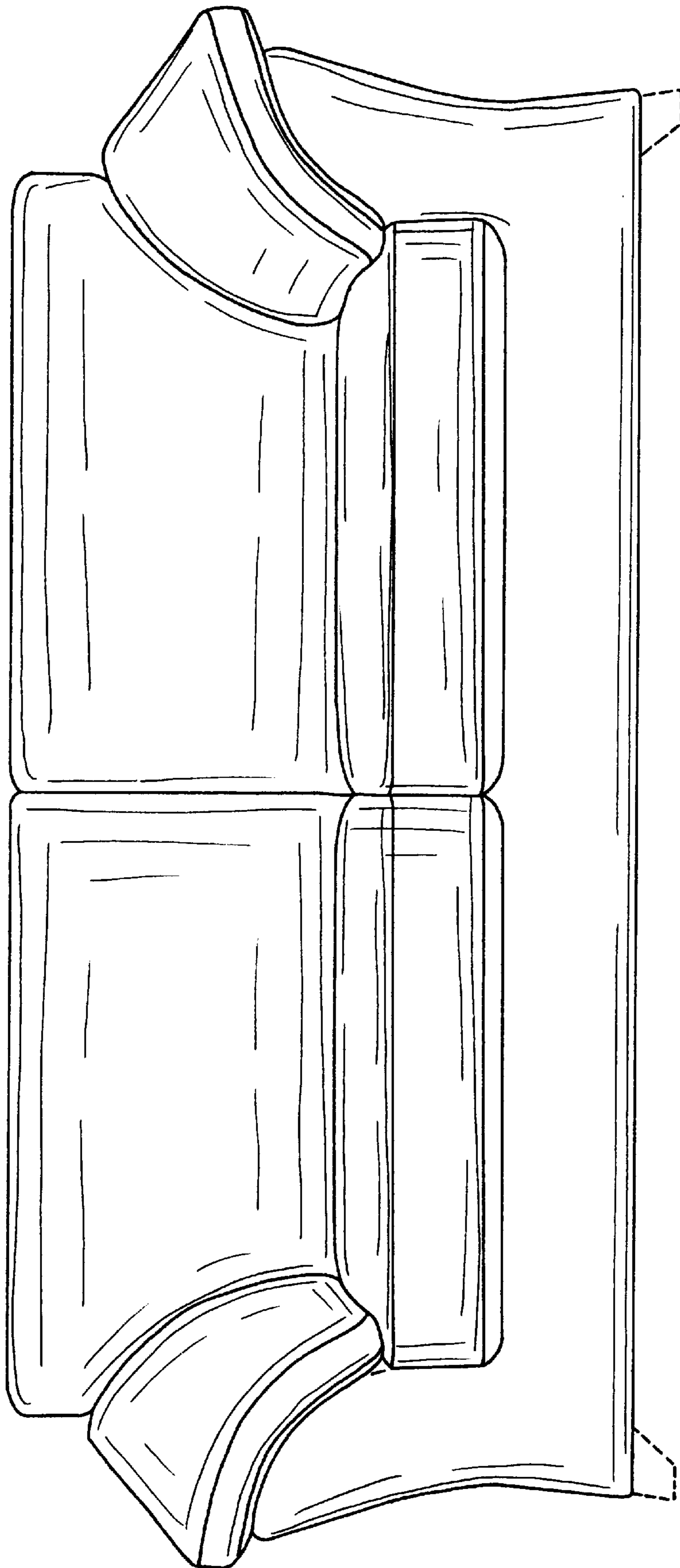

FIG. 1.

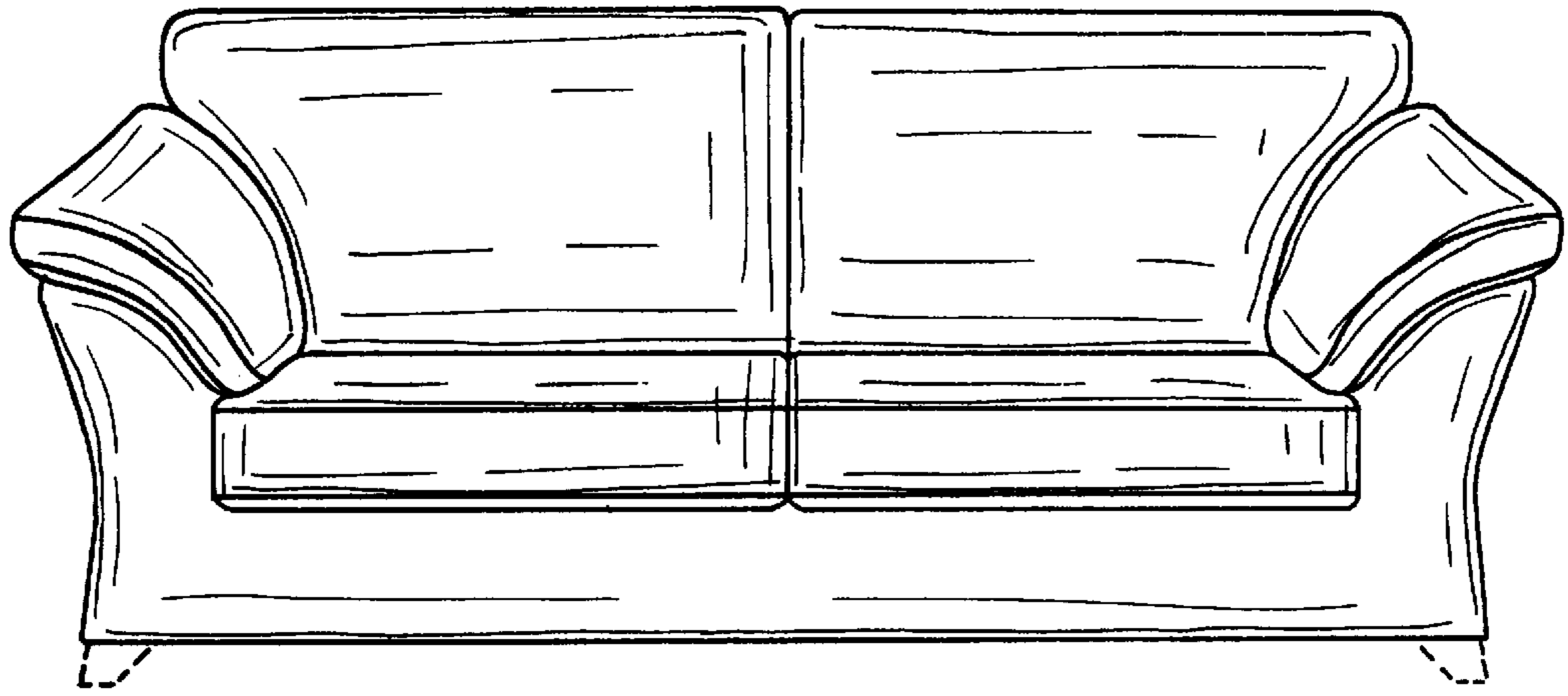

FIG. 2.

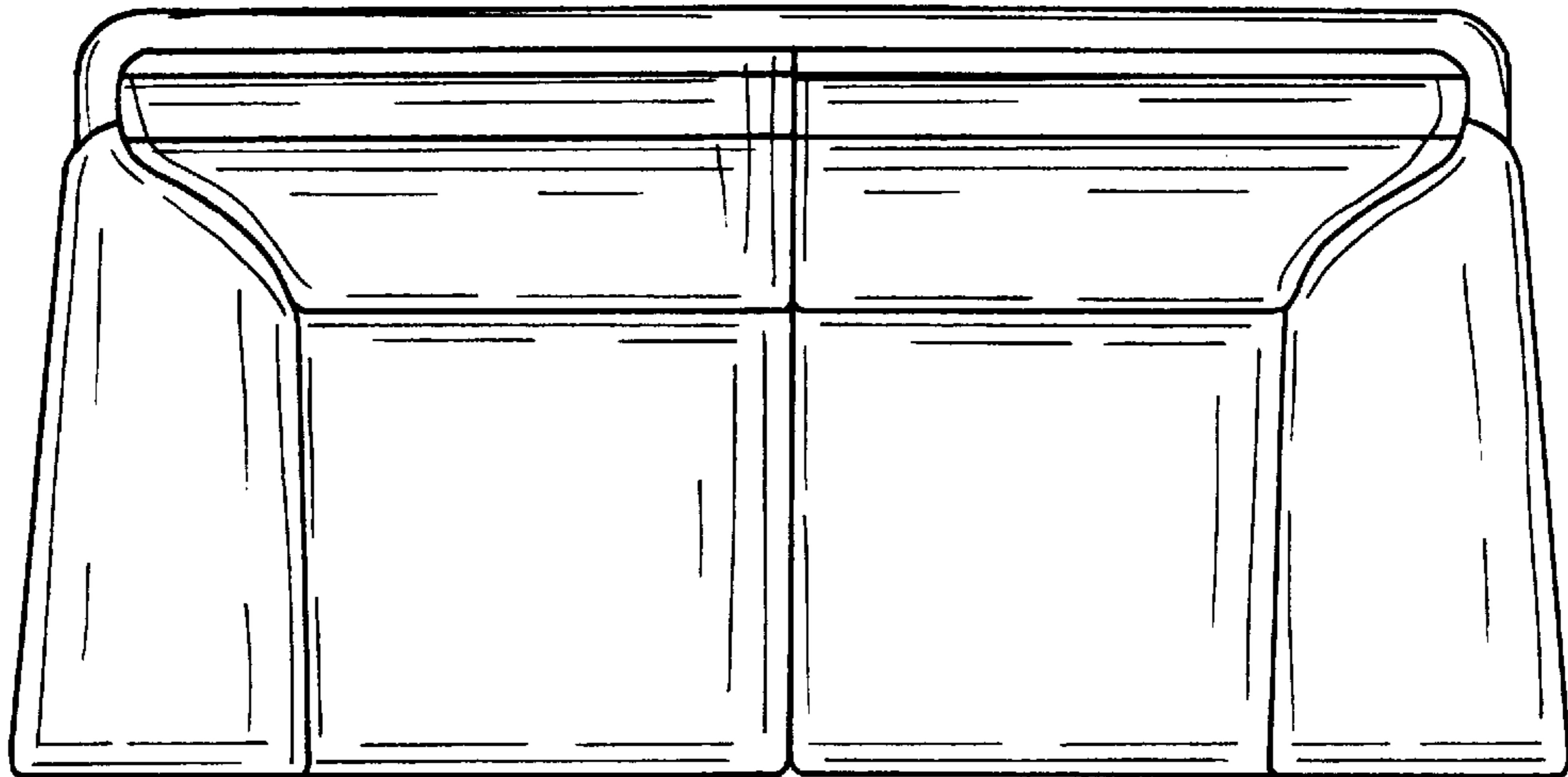

FIG. 3.

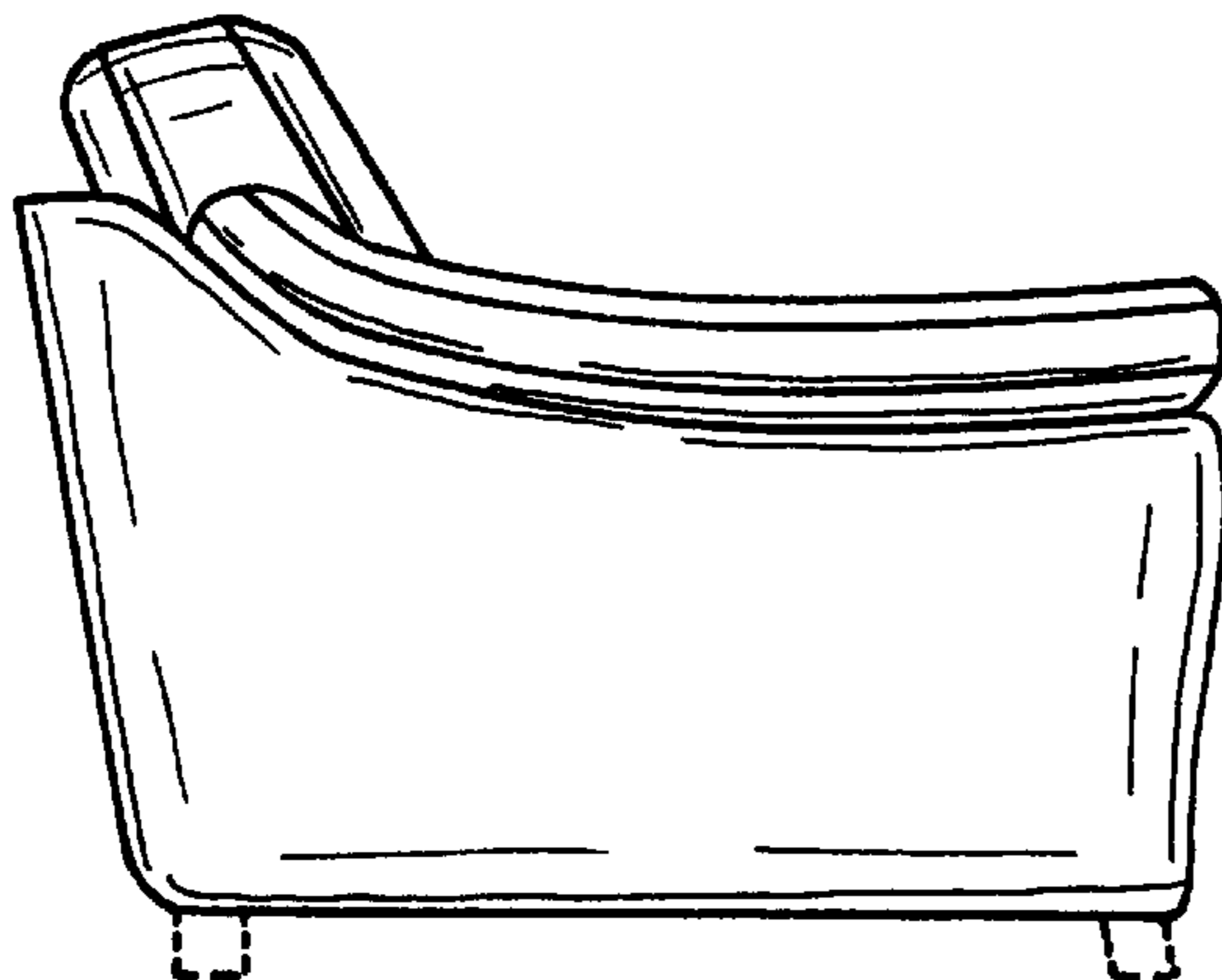

FIG. 4.

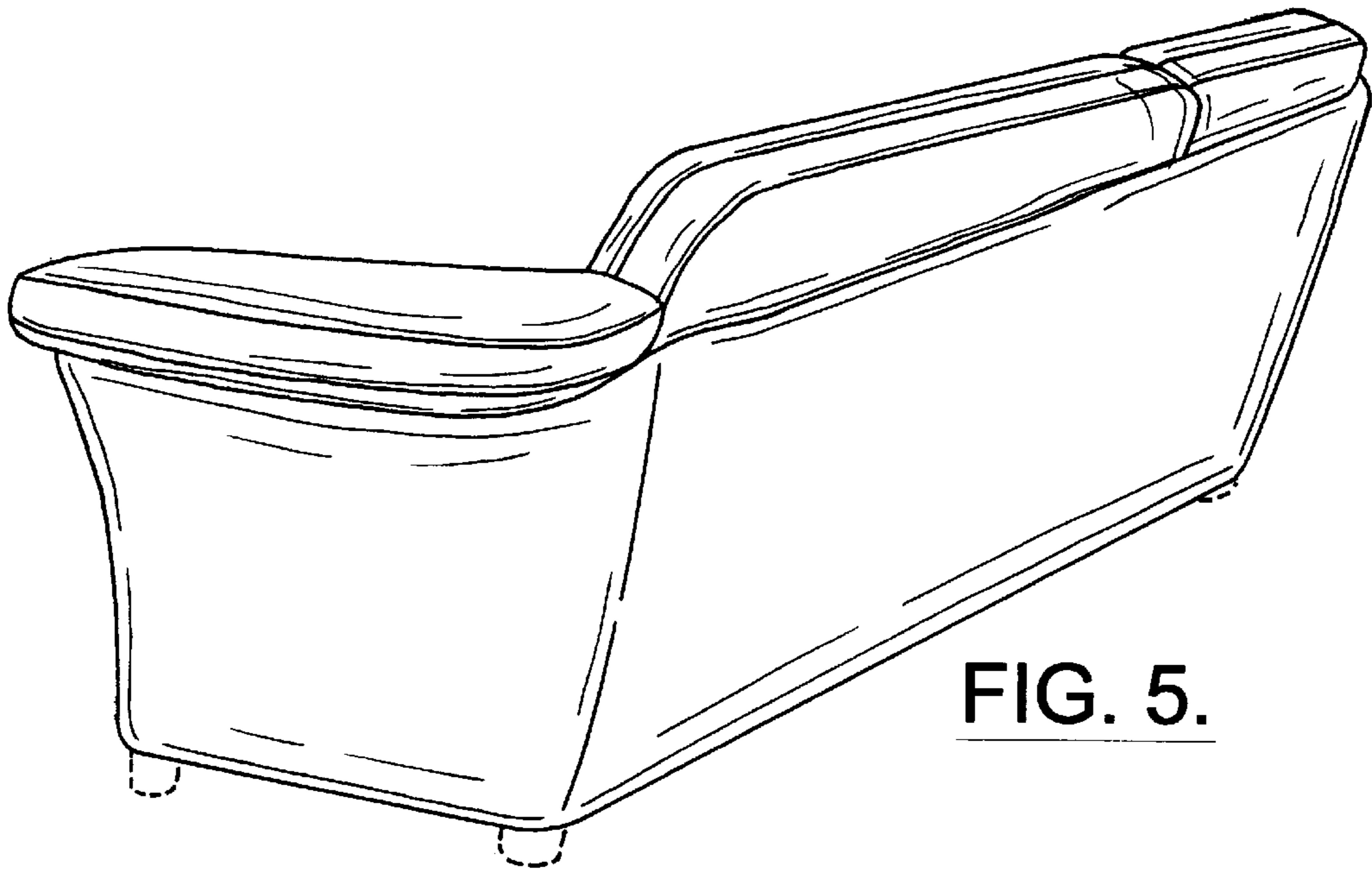

FIG. 5.

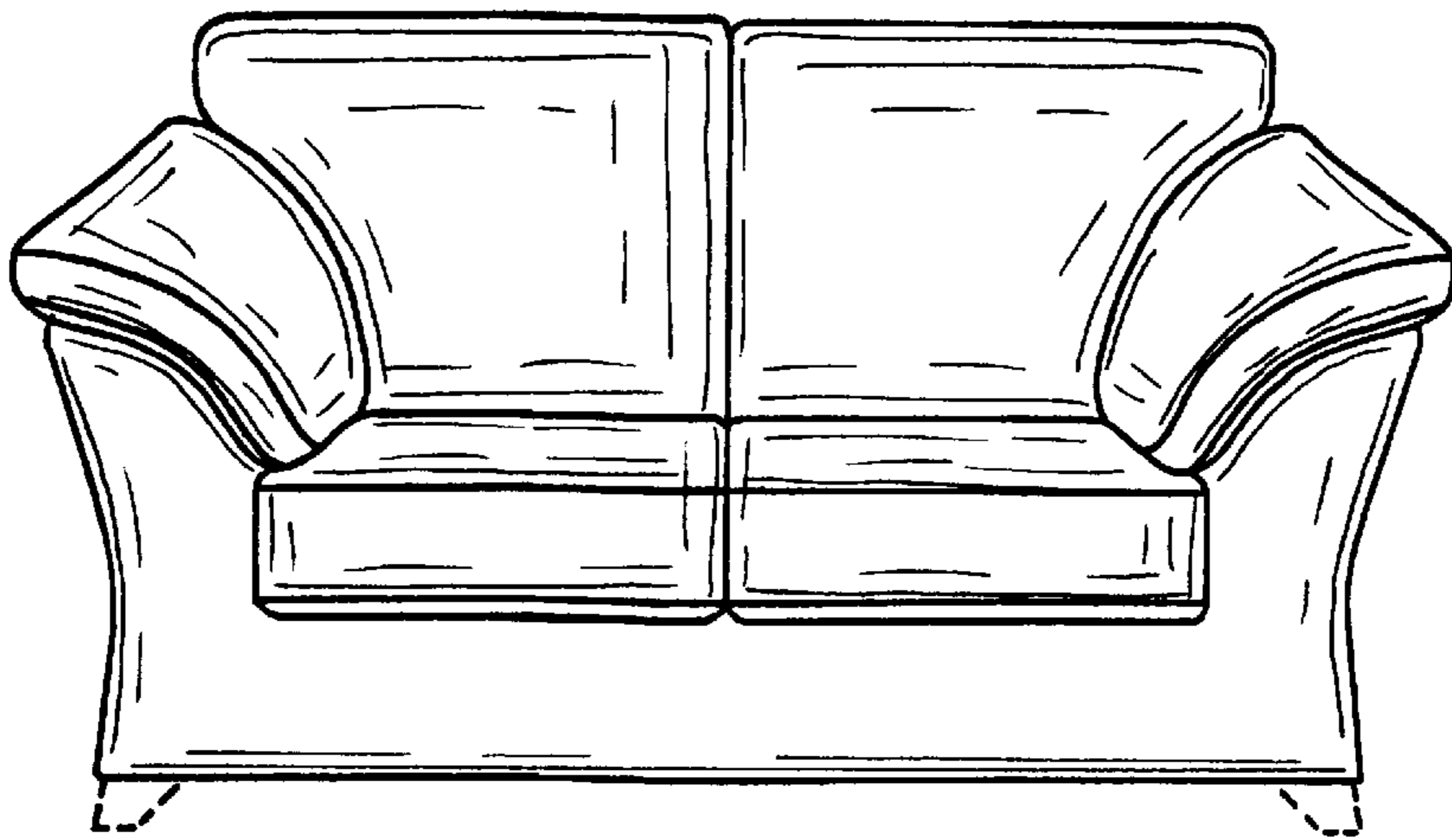

FIG. 6.

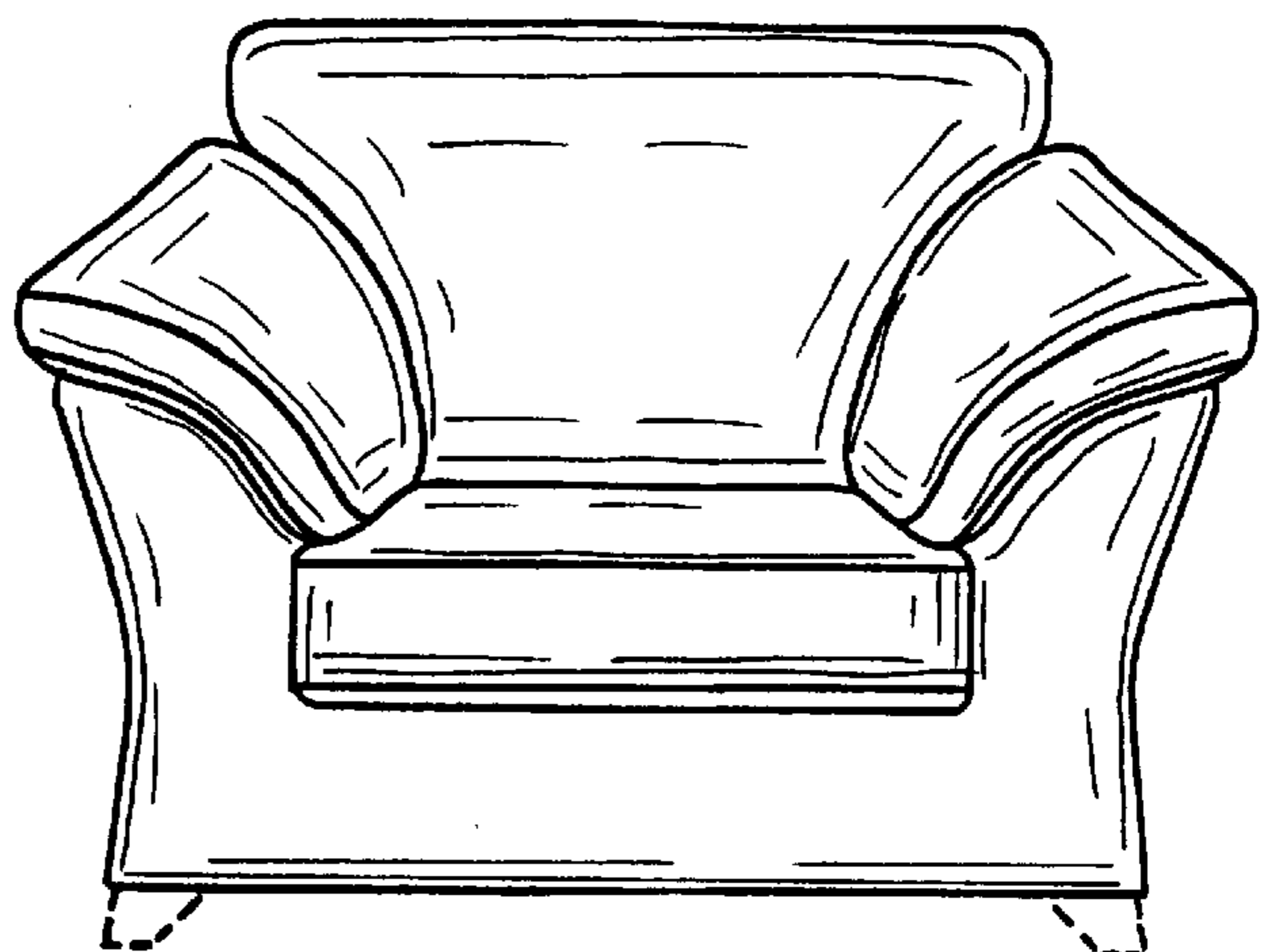

FIG. 7.