



US00D424316S

United States Patent [19]

[11] **Patent Number: Des. 424,316**

Natuzzi et al.

[45] **Date of Patent: ** May 9, 2000**

[54] **SEAT**

[75] Inventors: **Pasquale Natuzzi, Bari; Arcangelo Scarati, Taranto, both of Italy**

[73] Assignee: **Industrie Natuzzi, Spa, Bari, Italy**

[**] Term: **14 Years**

[21] Appl. No.: **29/103,873**

[22] Filed: **Apr. 23, 1999**

[51] **LOC (7) Cl. 06-01**

[52] **U.S. Cl. D6/381; D6/334**

[58] **Field of Search D6/334, 335, 336, D6/364, 371, 373, 381, 500, 501, 502; 5/12.1; 297/232, 445.1, 446.1**

[56] **References Cited**

U.S. PATENT DOCUMENTS

D. 94,831	3/1935	Granovsky	D6/381
D. 98,545	2/1936	Pumphrey	D6/364
D. 98,546	2/1936	Pumphrey	D6/364
D. 243,372	2/1977	Denny et al.	D6/364
D. 246,143	10/1977	Nash	D6/381
D. 250,233	11/1978	Opper	D6/371
D. 257,454	10/1980	Nash	D6/364
D. 263,770	4/1982	Melchior	D6/334
D. 353,273	12/1994	Natuzzi et al.	D6/381
D. 362,353	9/1995	Natuzzi et al.	D6/381
D. 372,808	8/1996	Natuzzi et al.	D6/381
D. 393,758	4/1998	Natuzzi et al.	D6/381
D. 409,014	5/1999	Natuzzi et al.	D6/381

OTHER PUBLICATIONS

Natuzzi Model ORIONE, Oct. 1984, at International Home Furnishings Market in High Point, North Carolina.
 Natuzzi Model 138, at least as early as 1987, at International Home Furnishings Market in High Point, North Carolina.
 Natuzzi Model 139, at least as early as 1987, at International Home Furnishings Market in High Point, North Carolina.
 Natuzzi Model 183, Apr. 1987, at International Home Furnishings Market in High Point, North Carolina.

Natuzzi Model 185, Oct. 1987, at International Home Furnishings Market in High Point, North Carolina.
 Natuzzi Model 710, at least as early as 1987, at International Home Furnishings Market in High Point, North Carolina.
 Natuzzi Model 720, Oct. 1989, at International Home Furnishings Market in High Point, North Carolina.
 Natuzzi Model 739, Apr. 1990, at International Home Furnishings Market in High Point, North Carolina.
 Natuzzi Model 783, Oct. 1990, at International Home Furnishings Market in High Point, North Carolina.
 Natuzzi Model 801, Oct. 1990, at International Home Furnishings Market in High Point, North Carolina.
 Natuzzi Model 843, Apr. 1991, at International Home Furnishings Market in High Point, North Carolina.

(List continued on next page.)

Primary Examiner—Gary D. Watson
Attorney, Agent, or Firm—Alston & Bird LLP

[57] **CLAIM**

The ornamental design for a seat, as shown and described.

DESCRIPTION

FIG. 1 is a front perspective view of a seat showing our new design in the form of a sofa;
 FIG. 2 is a front elevational view thereof;
 FIG. 3 is a top plan view thereof;
 FIG. 4 is a right side elevational view, the left side being a mirror image thereof;
 FIG. 5 is a rear perspective view thereof;
 FIG. 6 is a front perspective view of a seat showing our new design in the form of a loveseat; and,
 FIG. 7 is a front perspective view of a seat showing our new design in the form of a chair.
 The broken lines shown herein are for illustrative purposes only and form no part of the claimed design.
 The rear views of FIGS. 6 and 7 are like FIG. 5, the difference being a matter of length.
 The end views of FIGS. 6 and 7 are like FIG. 4.
 FIG. 1 is shown on an enlarged scale with respect to the other views.

1 Claim, 3 Drawing Sheets

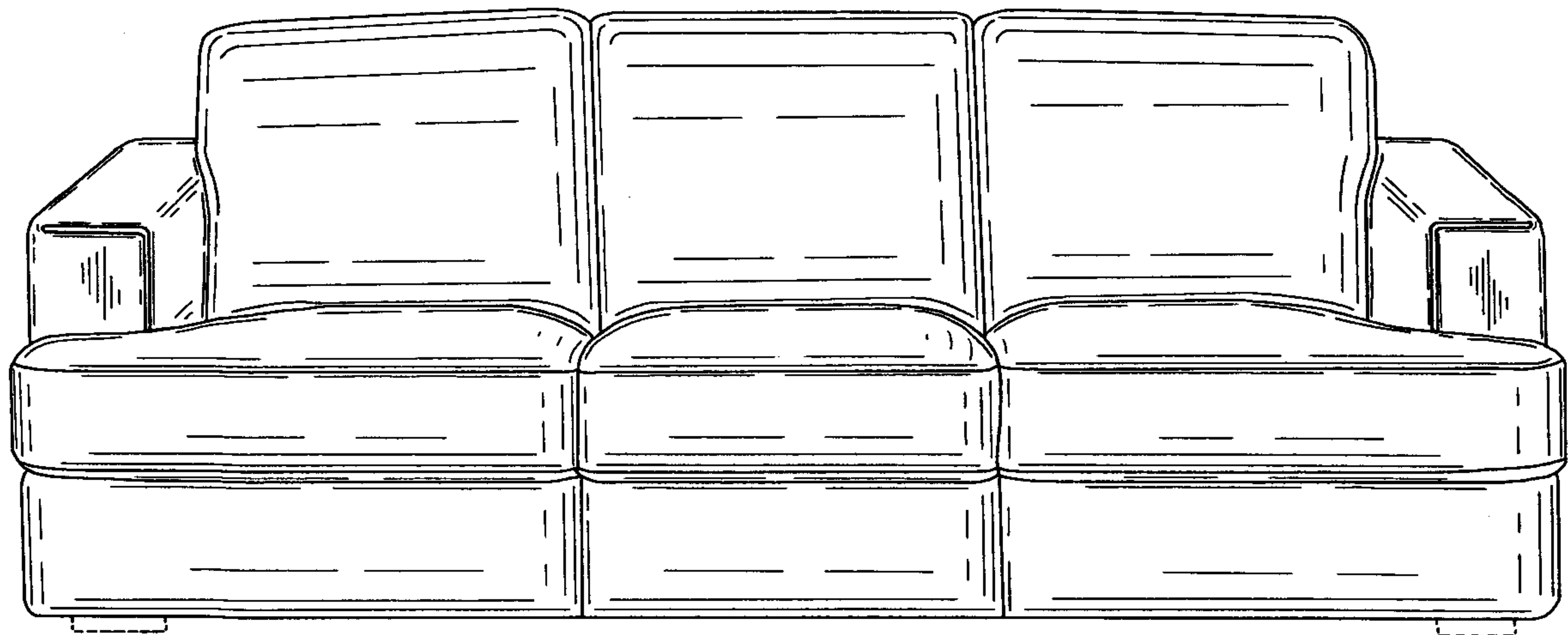

OTHER PUBLICATIONS

Natuzzi Model 938, Apr. 1992, at International Home Furnishings Market in High Point, North Carolina.
Natuzzi Model 946, Sep. 1992, at International Home Furnishings Market in High Point, North Carolina.
Natuzzi Model 956, Sep. 1992, at International Home Furnishings Market in High Point, North Carolina.
Natuzzi Model 982, Oct. 1992, at International Home Furnishings Market in High Point, North Carolina.
Natuzzi Model 985, Oct. 1992, at International Home Furnishings Market in High Point, North Carolina.
Natuzzi Model 998, Oct. 1993, at International Home Furnishings Market in High Point, North Carolina.
Natuzzi Model 1111, Oct. 1993, at International Home Furnishings Market in High Point, North Carolina.
Natuzzi Model 1179/1253, Apr. 1994, at International Home Furnishings Market in High Point, North Carolina.
Natuzzi Model 1180, Apr. 1994, at International Home Furnishings Market in High Point, North Carolina.
Natuzzi Model 1203, Oct. 1994, at International Home Furnishings Market in High point, North Carolina.
Natuzzi Model 1215, Oct. 1994, at International Home Furnishings Market in High Point, North Carolina.
Natuzzi Model 1228, Oct. 1994, at International Home Furnishings Market in High Point, North Carolina.
Natuzzi Model 1234/1251, Oct. 1994, at International Home Furnishings Market in High Point, North Carolina.

Natuzzi Model 1267, Mar. 1995, at International Home Furnishings Market in High Point, North Carolina.
Natuzzi Model 1301, Mar. 1995, at International Home Furnishings Market in High Point, North Carolina.
Natuzzi Model 1310, Apr. 1995, at International Home Furnishings Market in High Point, North Carolina.
Natuzzi Model 1312, Apr. 1995, at International Home Furnishings Market in High Point, North Carolina.
Natuzzi Model 1343, Sep. 1995, at International Home Furnishings Market in High Point, North Carolina.
Natuzzi Model 1463, Apr. 1996, at International Home Furnishings Market in High Point, North Carolina.
Natuzzi Model 1586, Apr. 1997, at International Home Furnishings Market in High Point, North Carolina.
Natuzzi Model 1600, Oct. 1997, at International Home Furnishings Market in High Point, North Carolina.
Natuzzi Model 1624, Oct. 1997, at International Home Furnishings Market in High Point, North Carolina.
Natuzzi Model 1635, Oct. 1997, at International Home Furnishings Market in High Point, North Carolina.
Natuzzi Model 1637, Oct. 1997, at International Home Furnishings Market in High Point, North Carolina.
Natuzzi Model 1654, Oct. 1997, at International Home Furnishings Market in High Point, North Carolina.

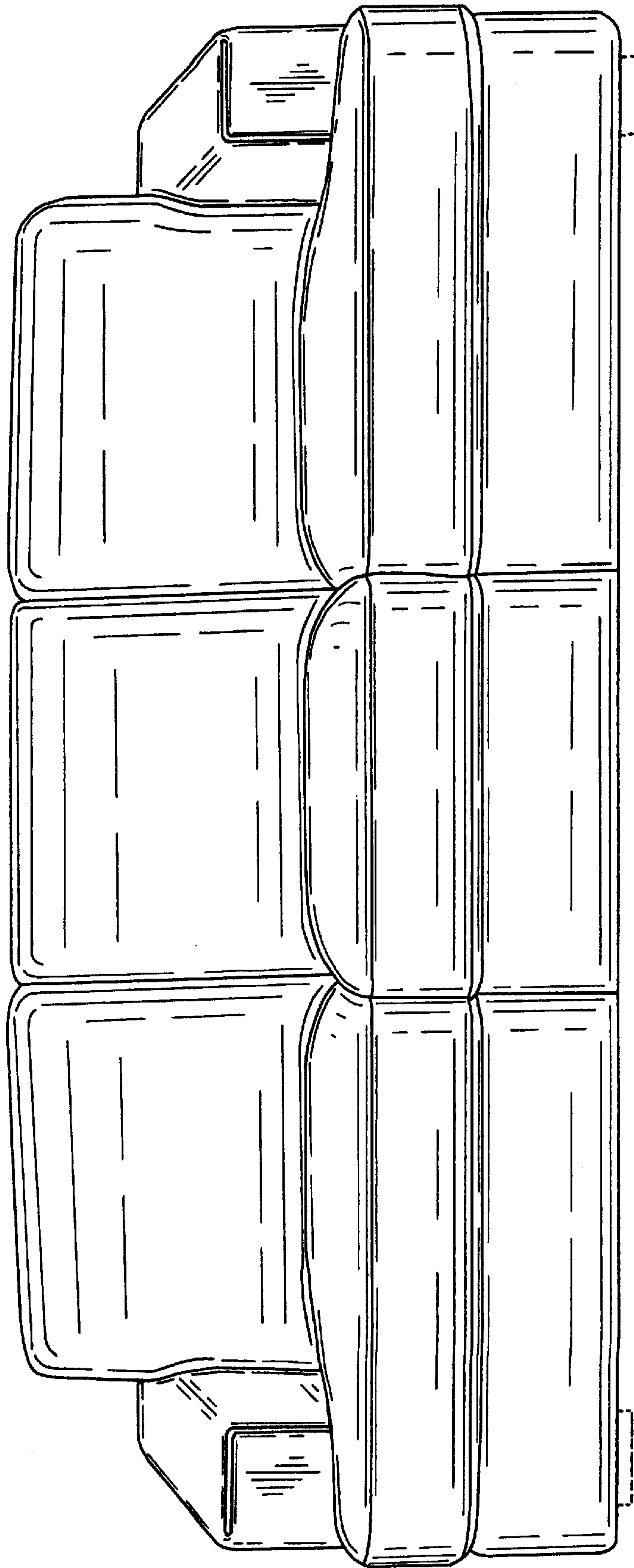

FIG. 1.

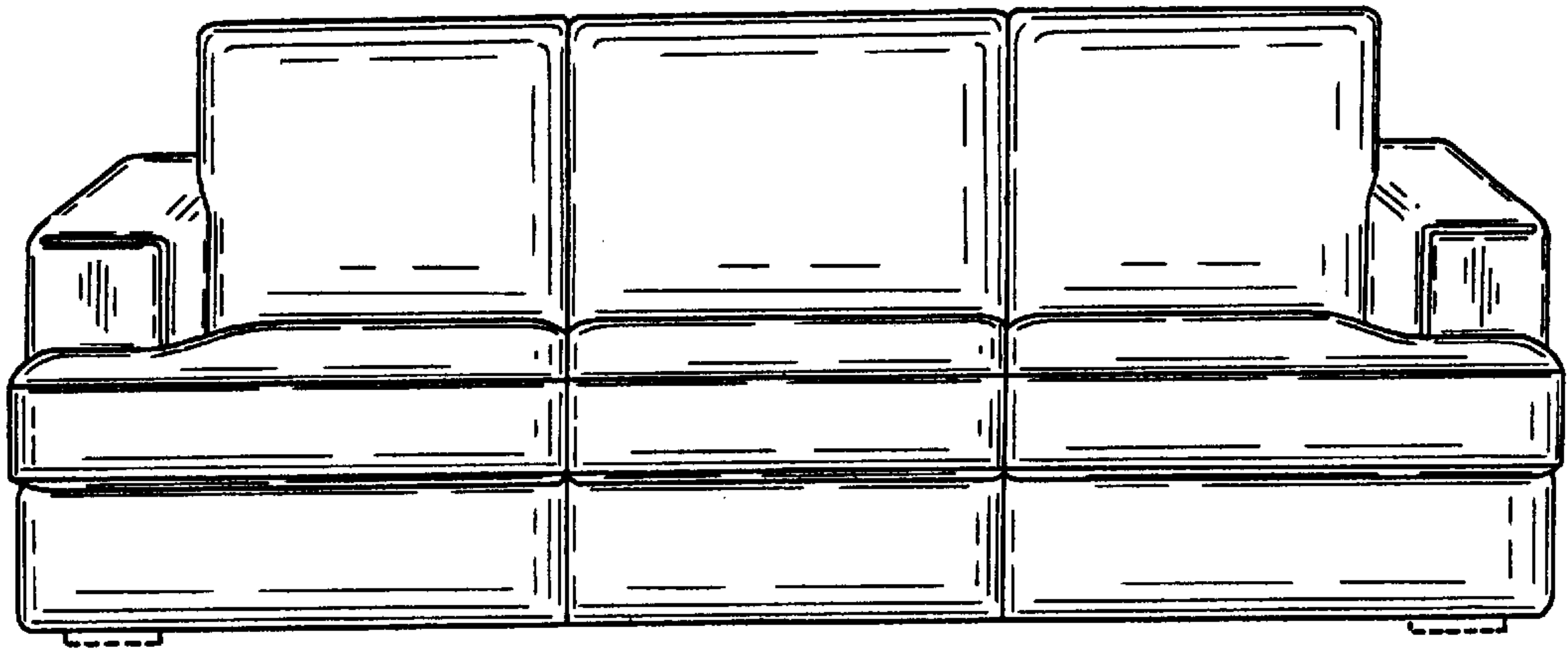

FIG. 2.

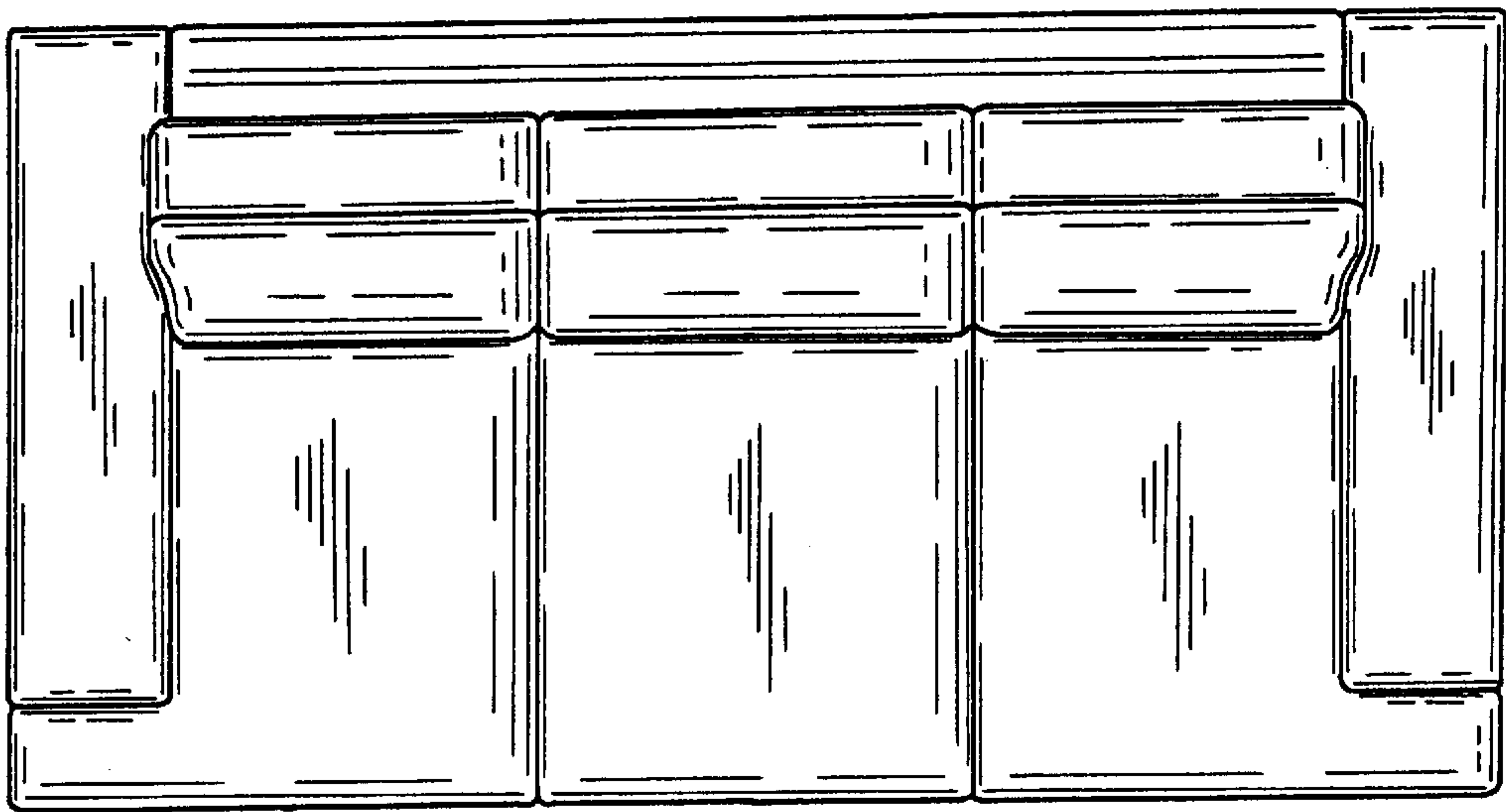

FIG. 3.

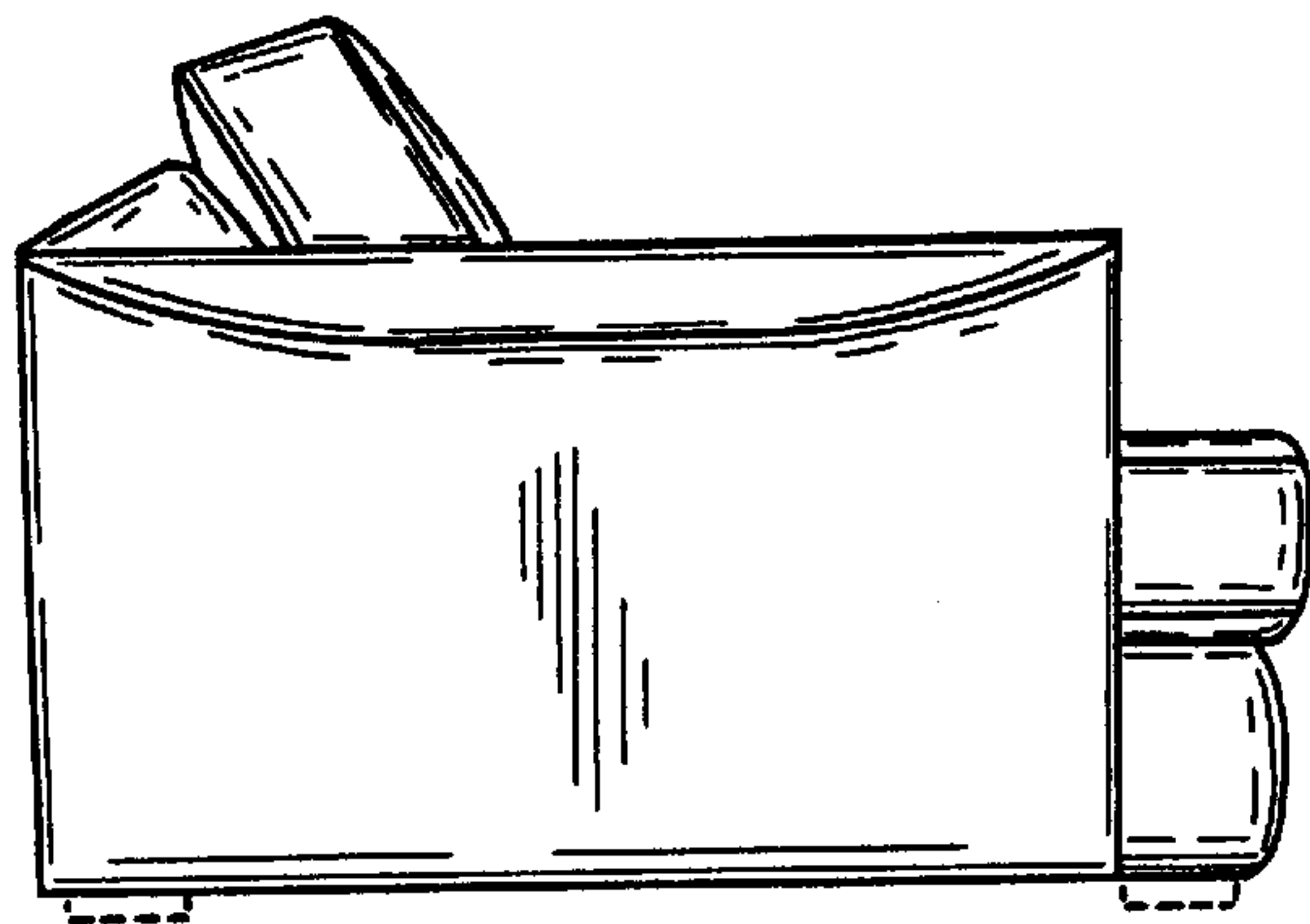

FIG. 4.

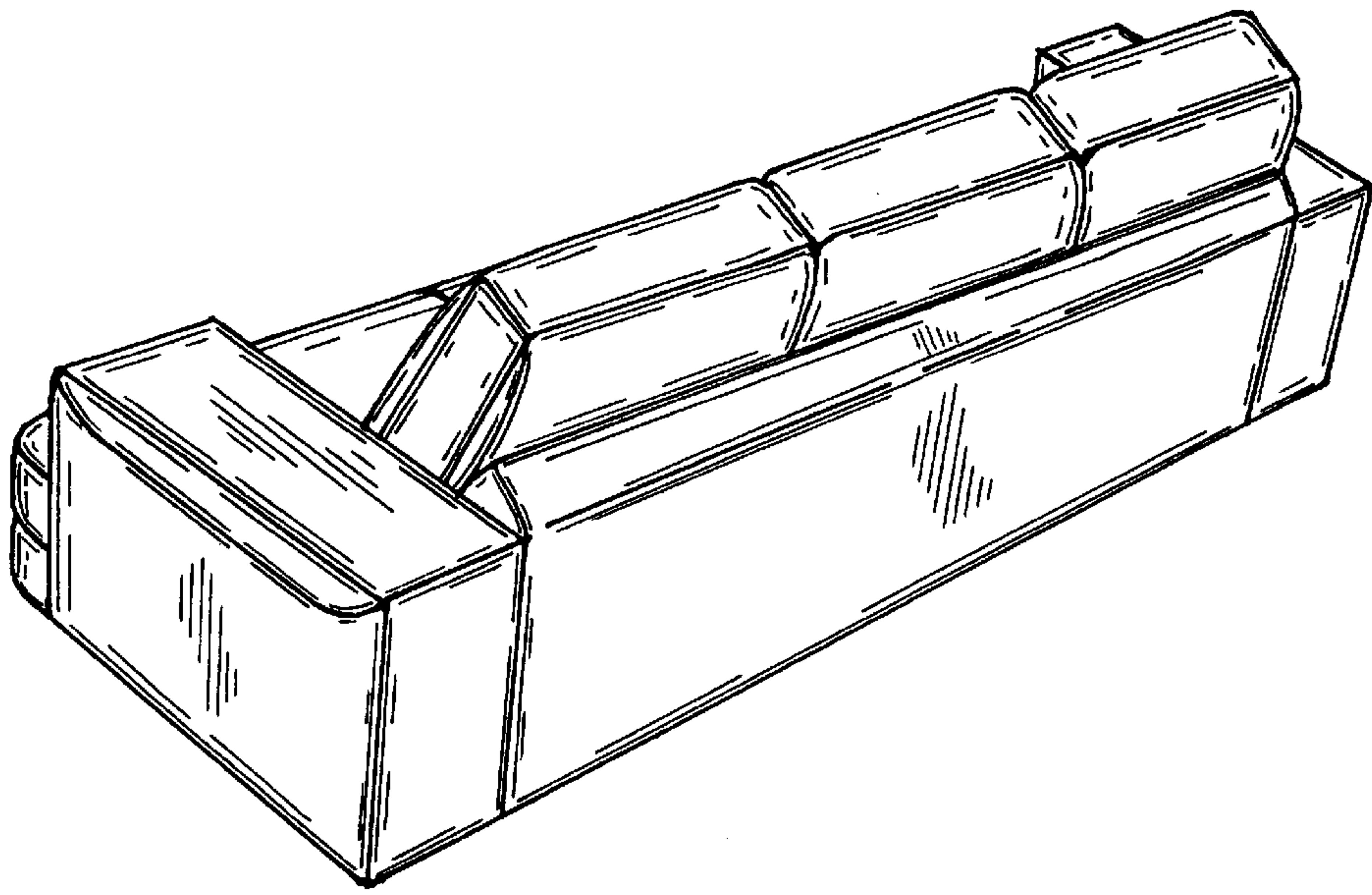

FIG. 5.

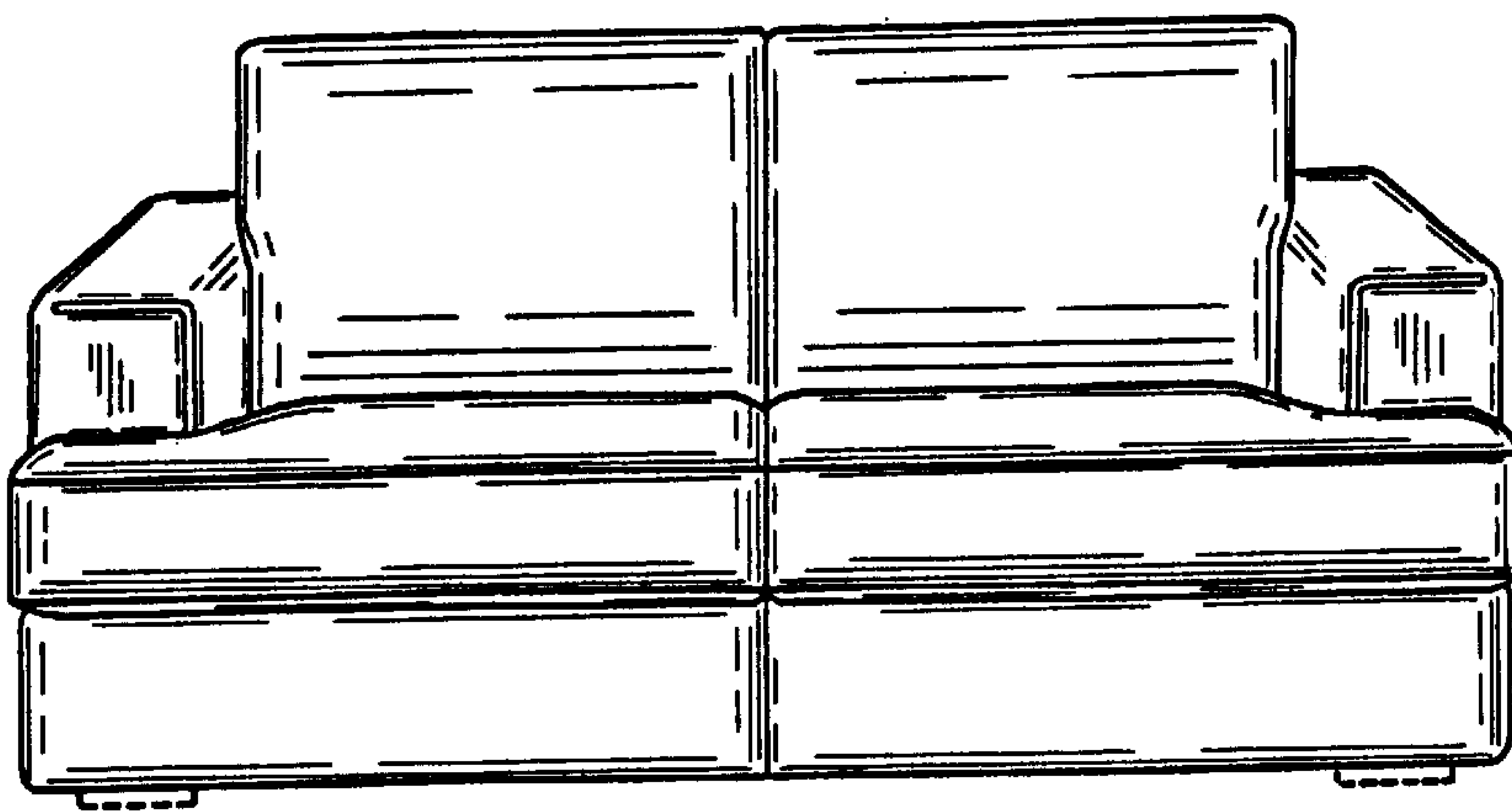

FIG. 6.

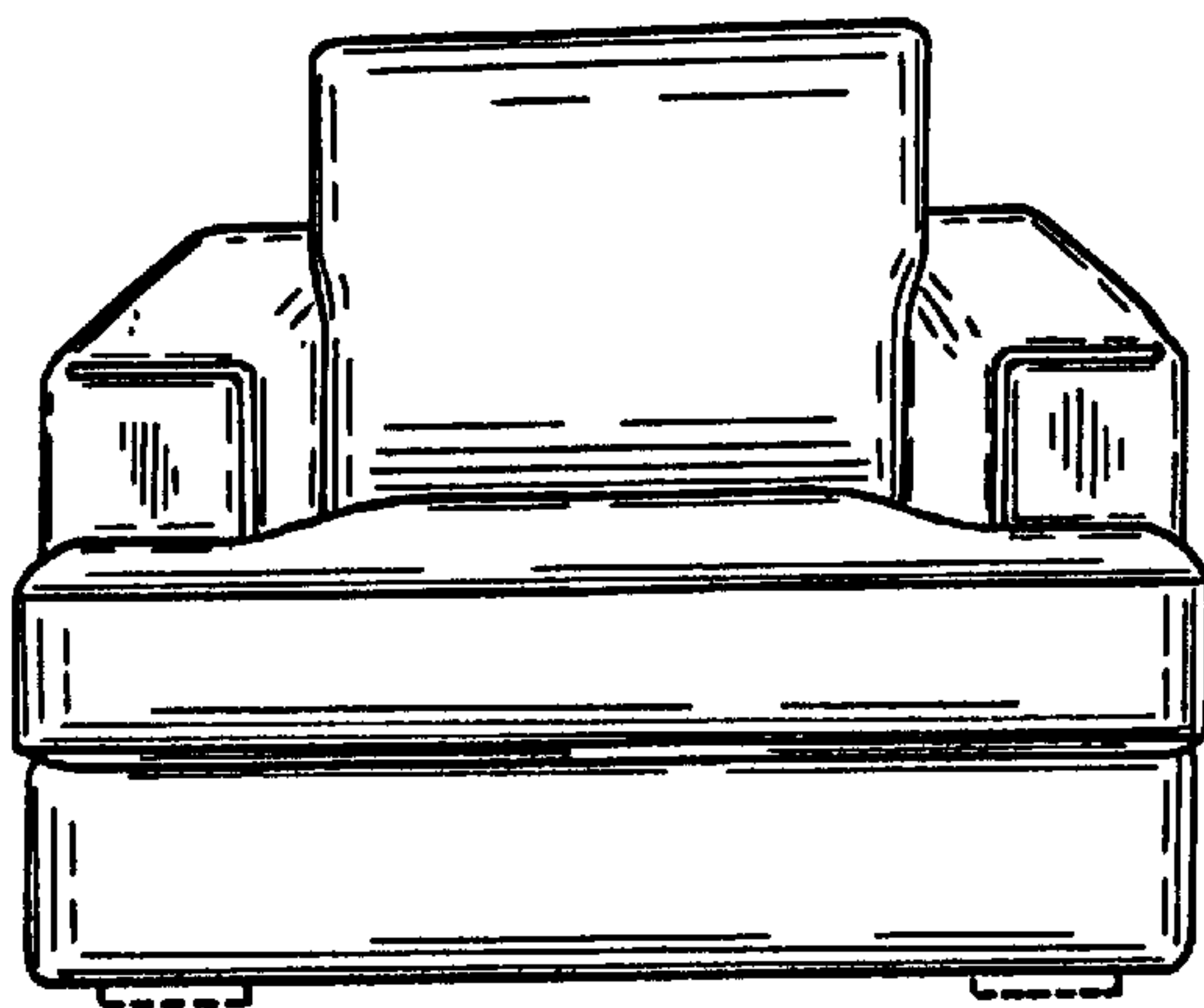

FIG. 7.