



US00D424220S

United States Patent [19]

Hussaini et al.

[11] Patent Number: **Des. 424,220**

[45] Date of Patent: **** May 2, 2000**

[54] **LIGHT**

D. 357,329 4/1995 Iacovelli D26/28

[75] Inventors: **Saied Hussaini; Marc Iacovelli**, both of Miami, Fla.

Primary Examiner—Marcus A. Jackson
Attorney, Agent, or Firm—Liniak, Berenato, Longacarde & White

[73] Assignee: **Rally Manufacturing, Inc.**, Miami, Fla.

[57] **CLAIM**

[**] Term: **14 Years**

The ornamental design for a light, as shown and described.

[21] Appl. No.: **29/107,352**

DESCRIPTION

[22] Filed: **Jul. 7, 1999**

[51] **LOC (7) Cl.** **26-06**

[52] **U.S. Cl.** **D26/28**

[58] **Field of Search** D26/28-36; 362/72, 362/157, 158, 183-208

FIG. 1 is a front view of a light showing my new design, with the broken line showing for illustrative purposes only and forming no part of the claimed design;
FIG. 2 is a rear view of the light shown in FIG. 1.
FIG. 3 is a top view of the light shown in FIG. 1.
FIG. 4 is a bottom view of the light shown in FIG. 1.
FIG. 5 is right side view of the light shown in FIG. 1.
FIG. 6 is a left side view of the light shown in FIG. 1; and,
FIG. 7 is a top and left side perspective view of the light shown in FIG. 1.

[56] **References Cited**

U.S. PATENT DOCUMENTS

D. 314,440 2/1991 Monier et al. D26/28

1 Claim, 4 Drawing Sheets

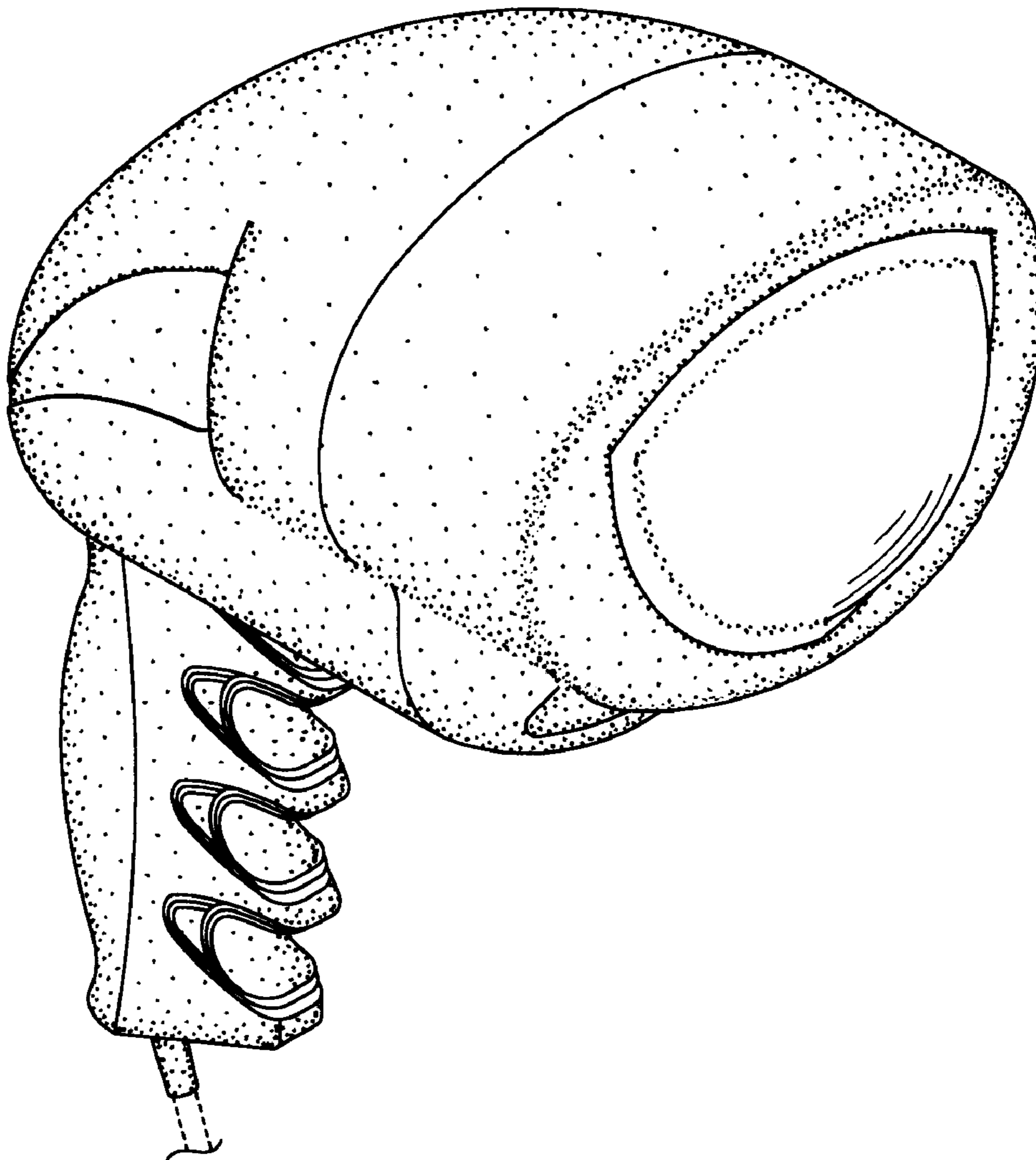

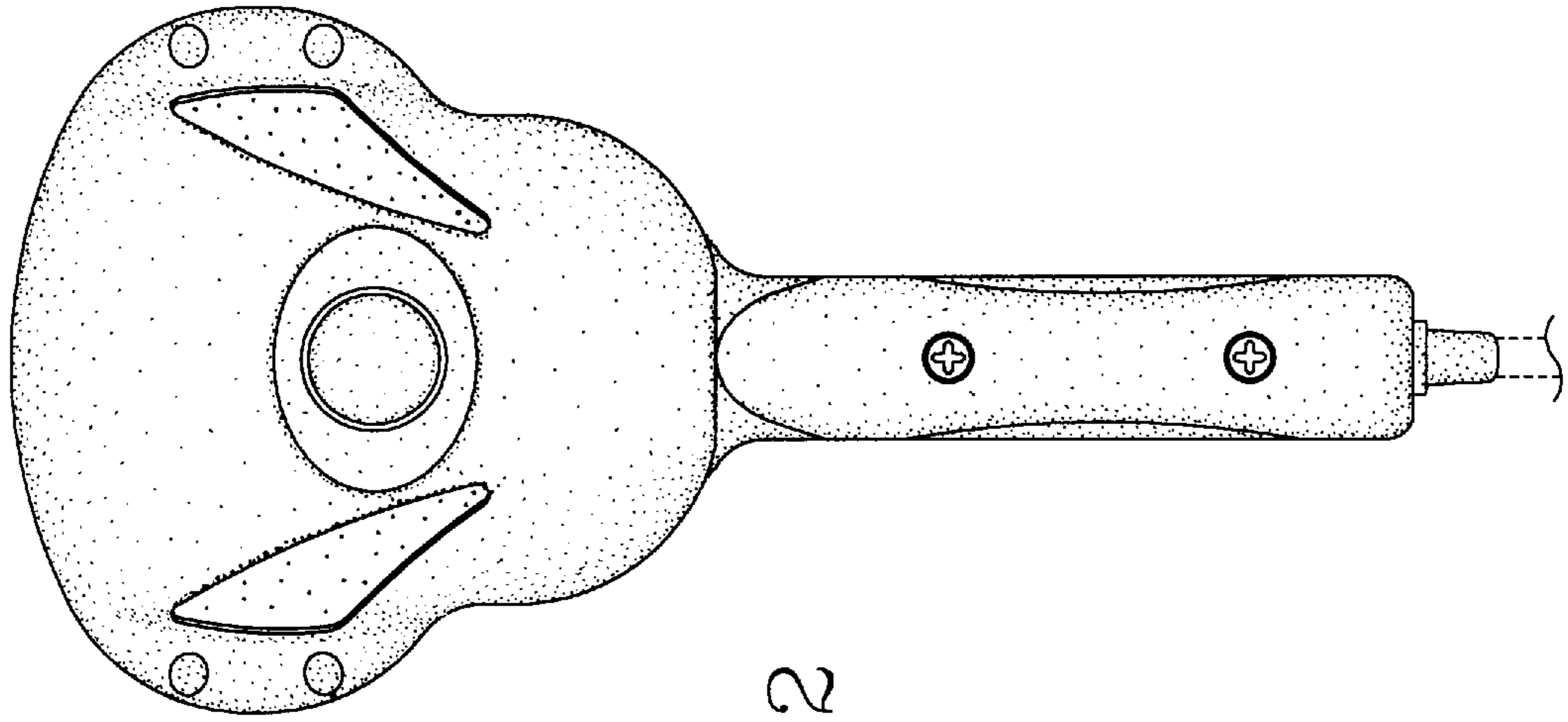

Fig. 2

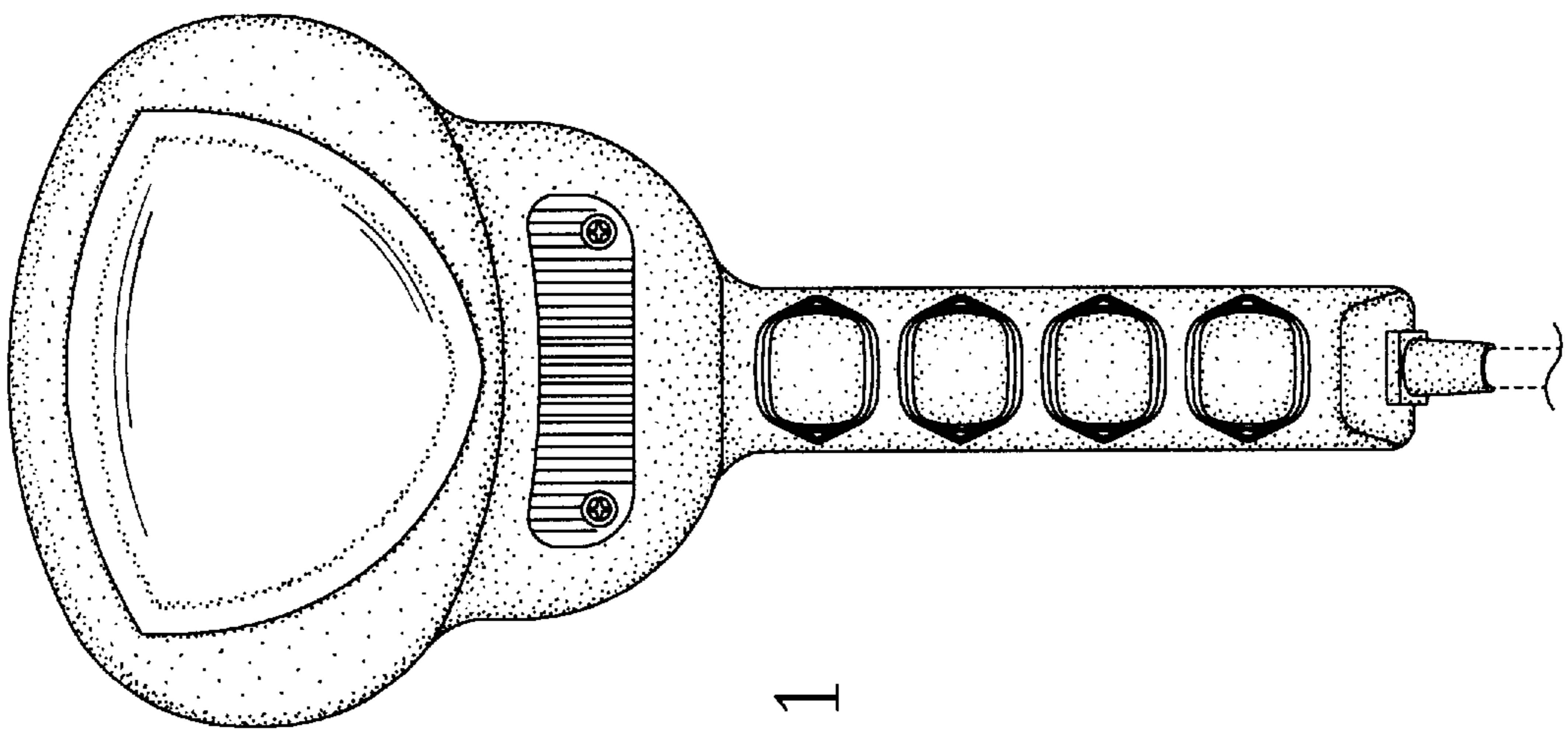

Fig. 1

Fig. 4

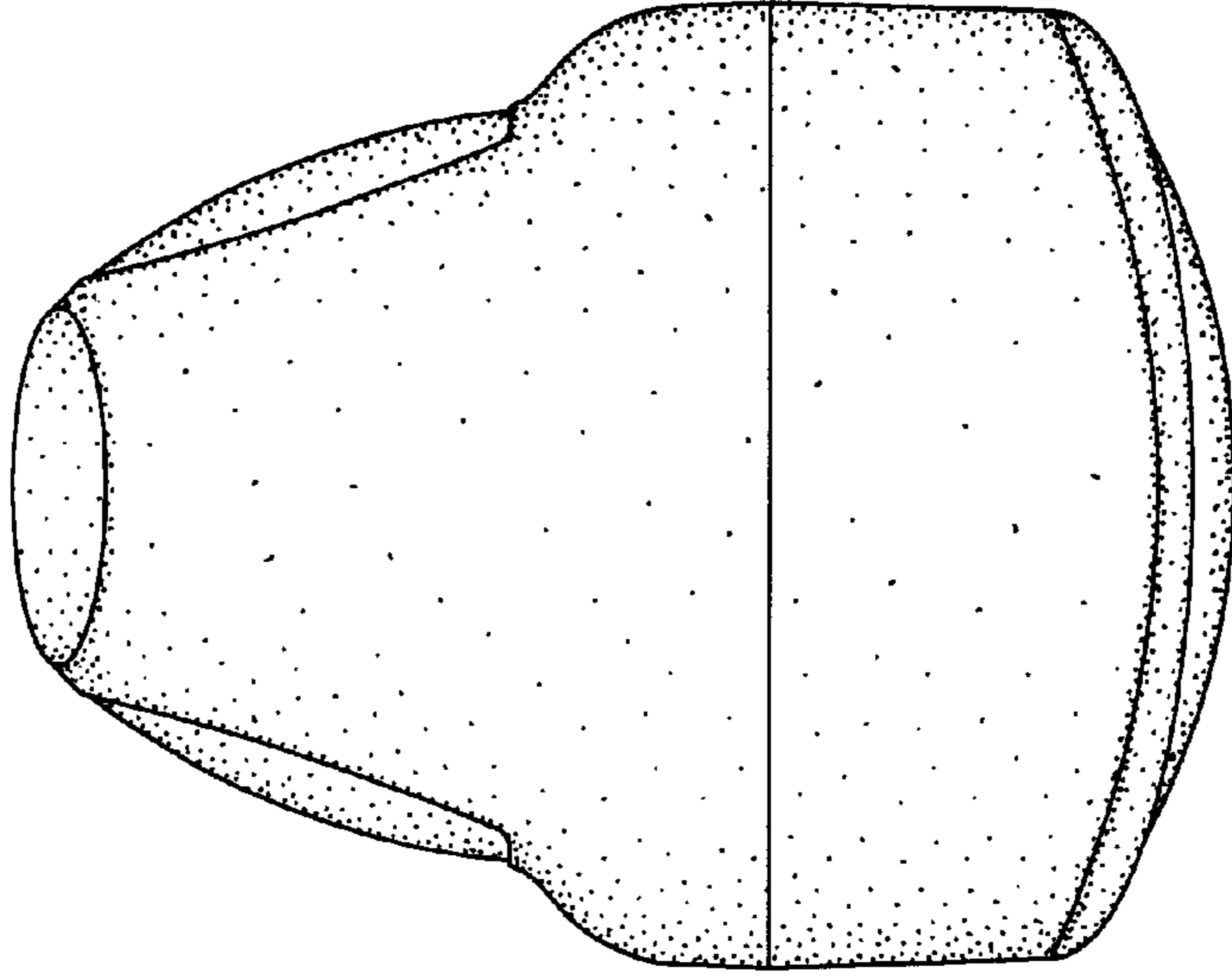
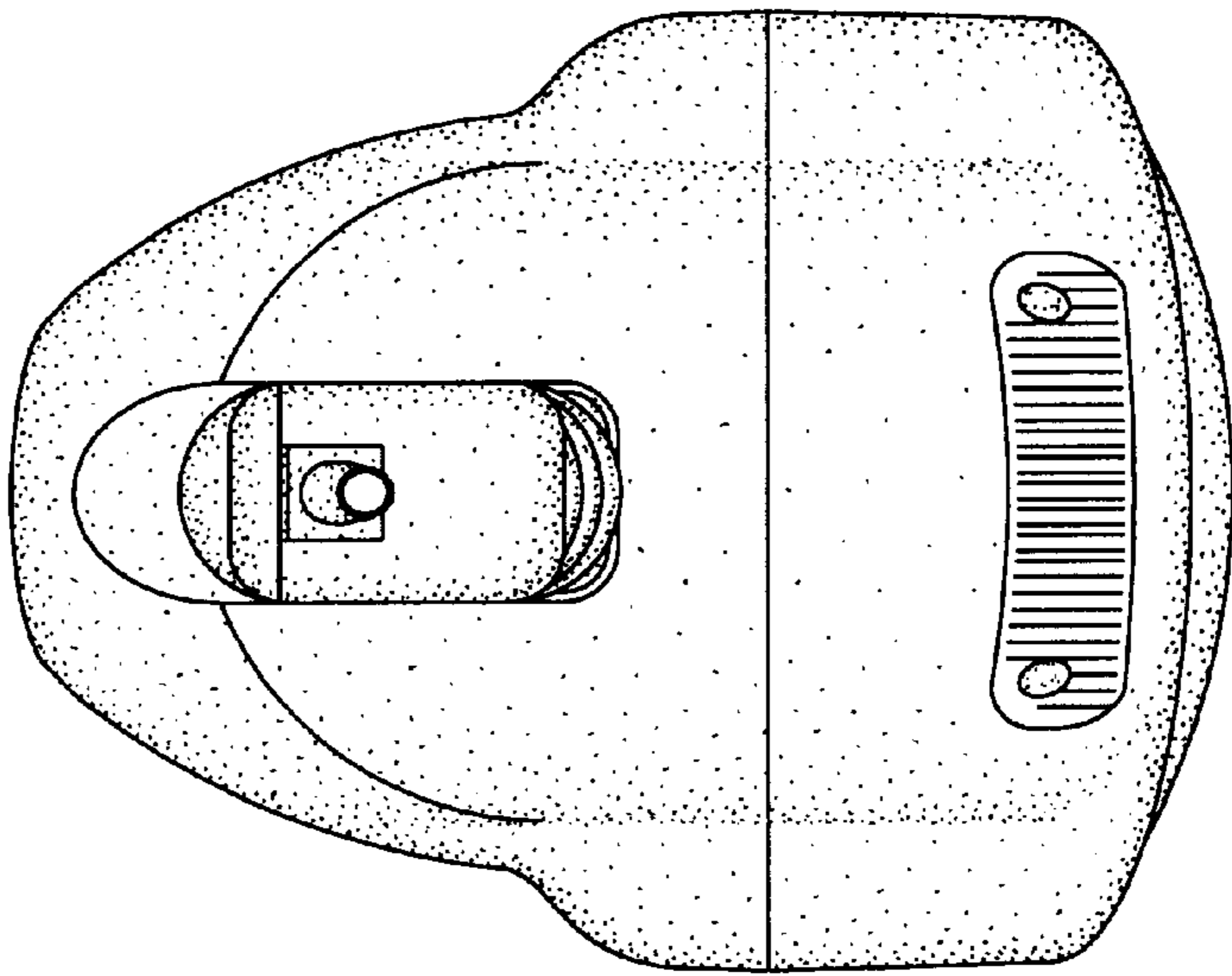

Fig. 3



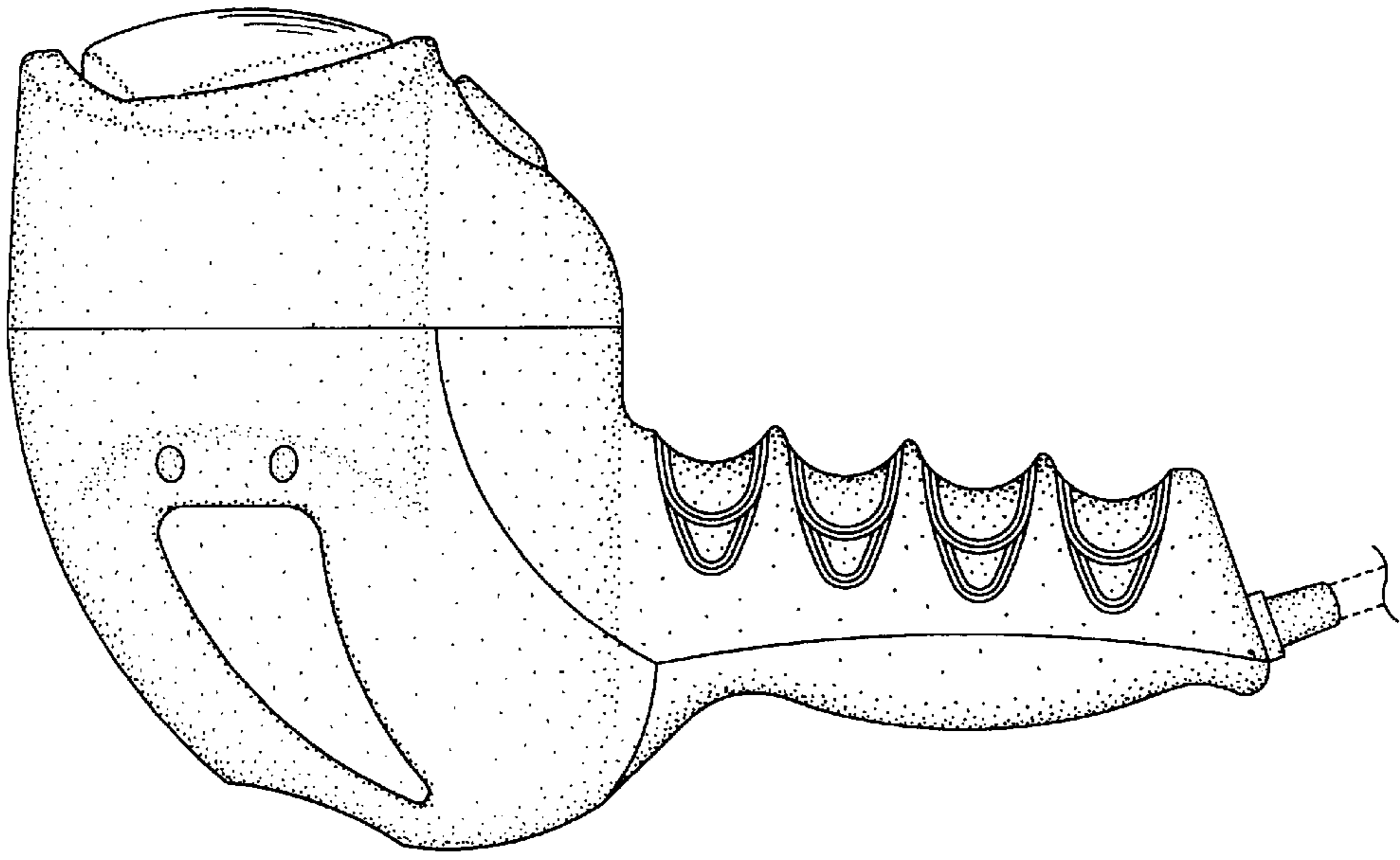

Fig. 6

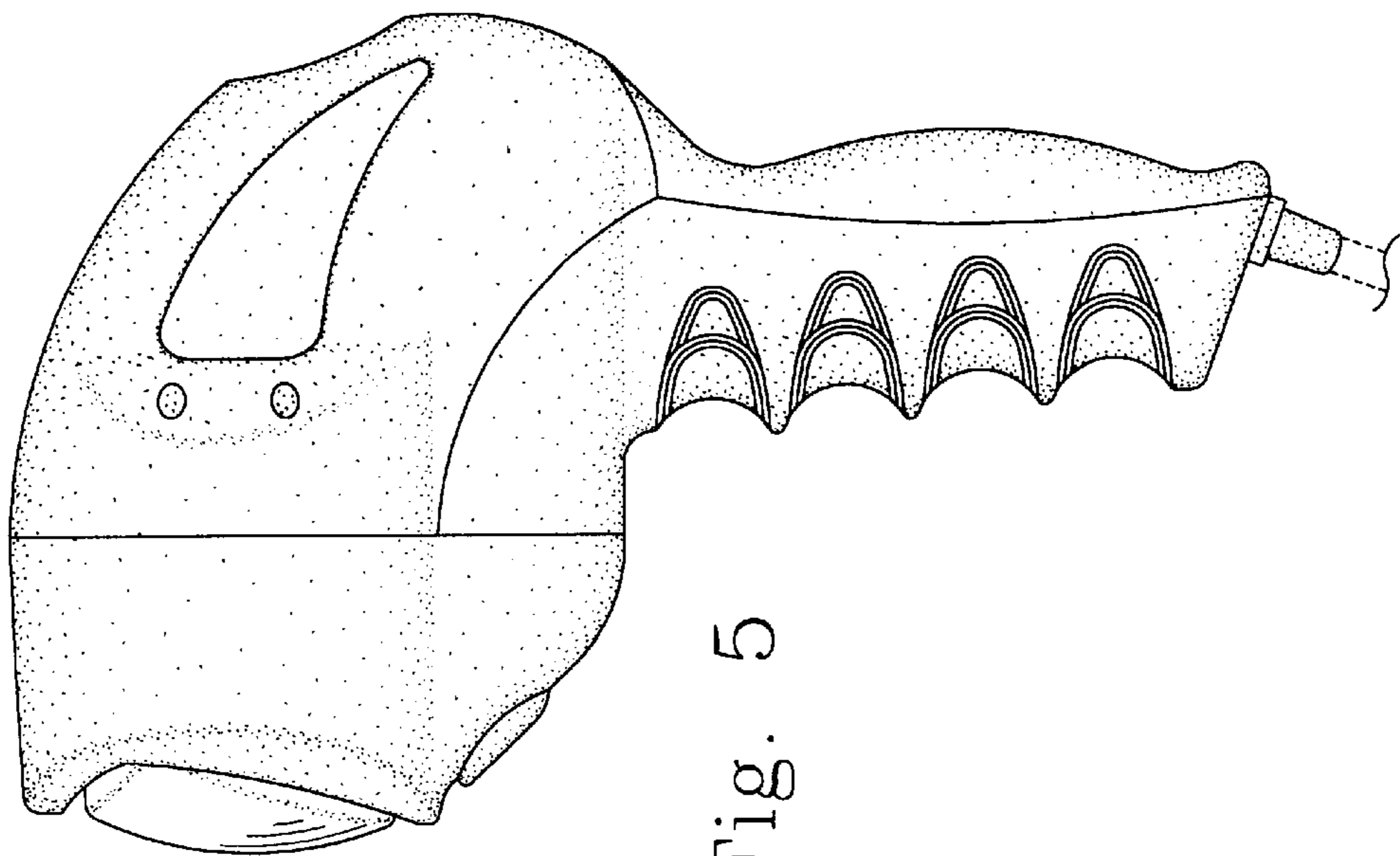

Fig. 5

Fig. 7

