



US00D424141S

United States Patent [19]
Eckmann

[11] **Patent Number: Des. 424,141**
[45] **Date of Patent: ** May 2, 2000**

[54] **WEIGHT STAND**

[75] Inventor: **James A. Eckmann**, Libertyville, Ill.

[73] Assignee: **Sportworks Ltd.**, Vernon Hills, Ill.

[**] Term: **14 Years**

[21] Appl. No.: **29/101,963**

[22] Filed: **Mar. 15, 1999**

[51] **LOC (7) Cl.** **21-02**

[52] **U.S. Cl.** **D21/686; D6/552**

[58] **Field of Search** D21/662, 686,
D21/691, 694; D6/467, 468, 552; 211/71,
85, 64; 482/104, 148, 93, 92

[56] **References Cited**

U.S. PATENT DOCUMENTS

D. 329,563	9/1992	Rusmussen	D6/552
D. 362,776	10/1995	Thorn	D6/552
D. 372,144	7/1996	Selby	D6/468
4,201,380	5/1980	Birch	211/85

OTHER PUBLICATIONS

Service Merchandise Catalog, p. 534, Dumbbell Rack #12, 1997.

Primary Examiner—Philip S. Hyder

Attorney, Agent, or Firm—Polster, Lieder, Woodruff & Lucchesi, L.C.

[57] **CLAIM**

The ornamental design for a weight stand, as shown and described.

DESCRIPTION

FIG. 1 is a perspective view of a weight stand showing my new design;

FIG. 2 is a view of the side elevation of the weight stand shown in FIG. 1;

FIG. 3 is a view in front elevation of the weight stand in folded condition;

FIG. 4 is a top plan view of the weight stand as shown in FIG. 3;

FIG. 5 is a bottom plan view of the weight stand shown in FIG. 4;

FIG. 6 is a view in rear elevation of the weight stand as shown in FIG. 3; and,

FIG. 7 is a right side elevation of the weight stand, in a folded position, wherein the broken line showing of the weight machine is for illustrative purposes only and forms no part of the claimed design.

1 Claim, 4 Drawing Sheets

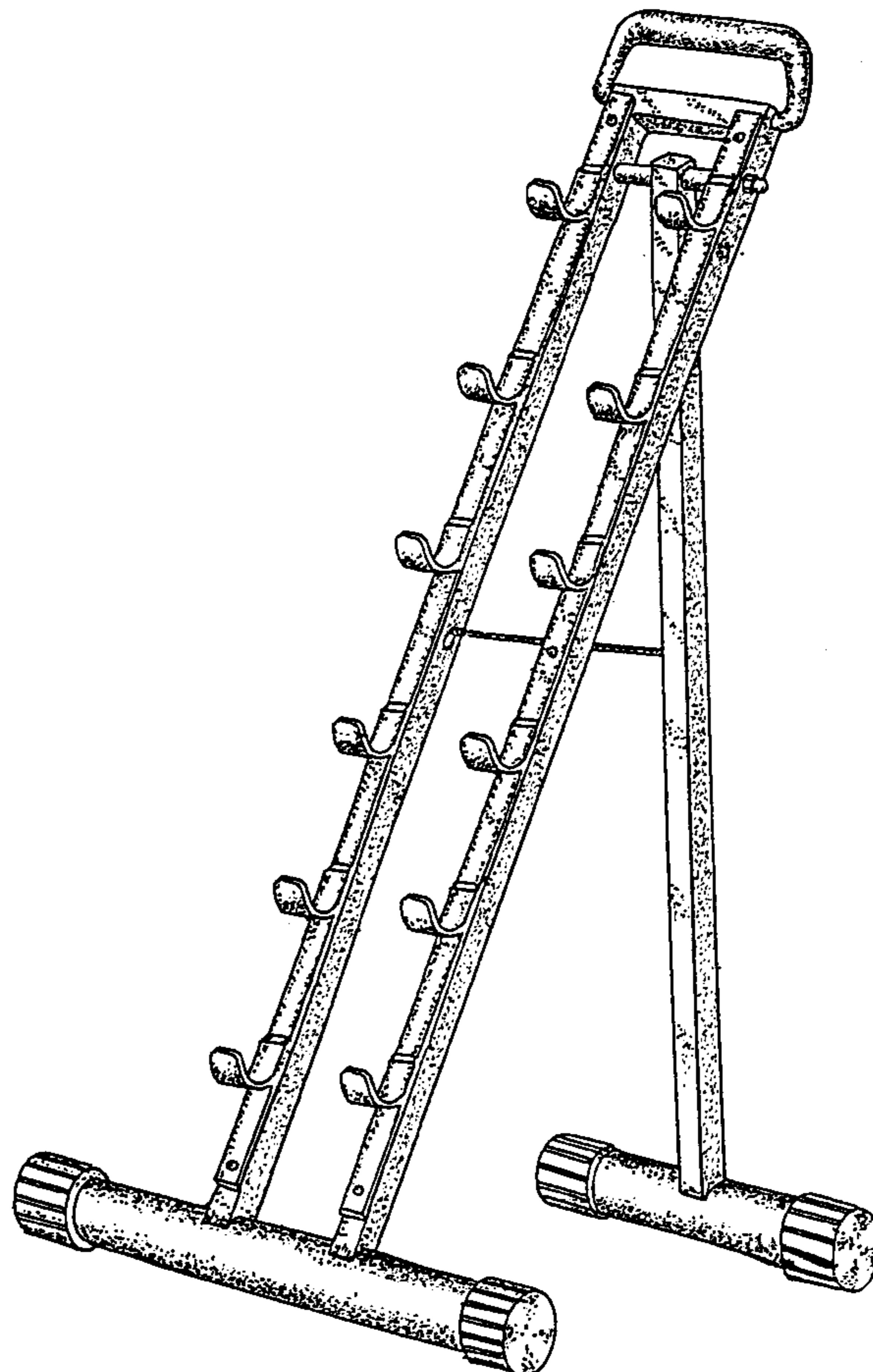

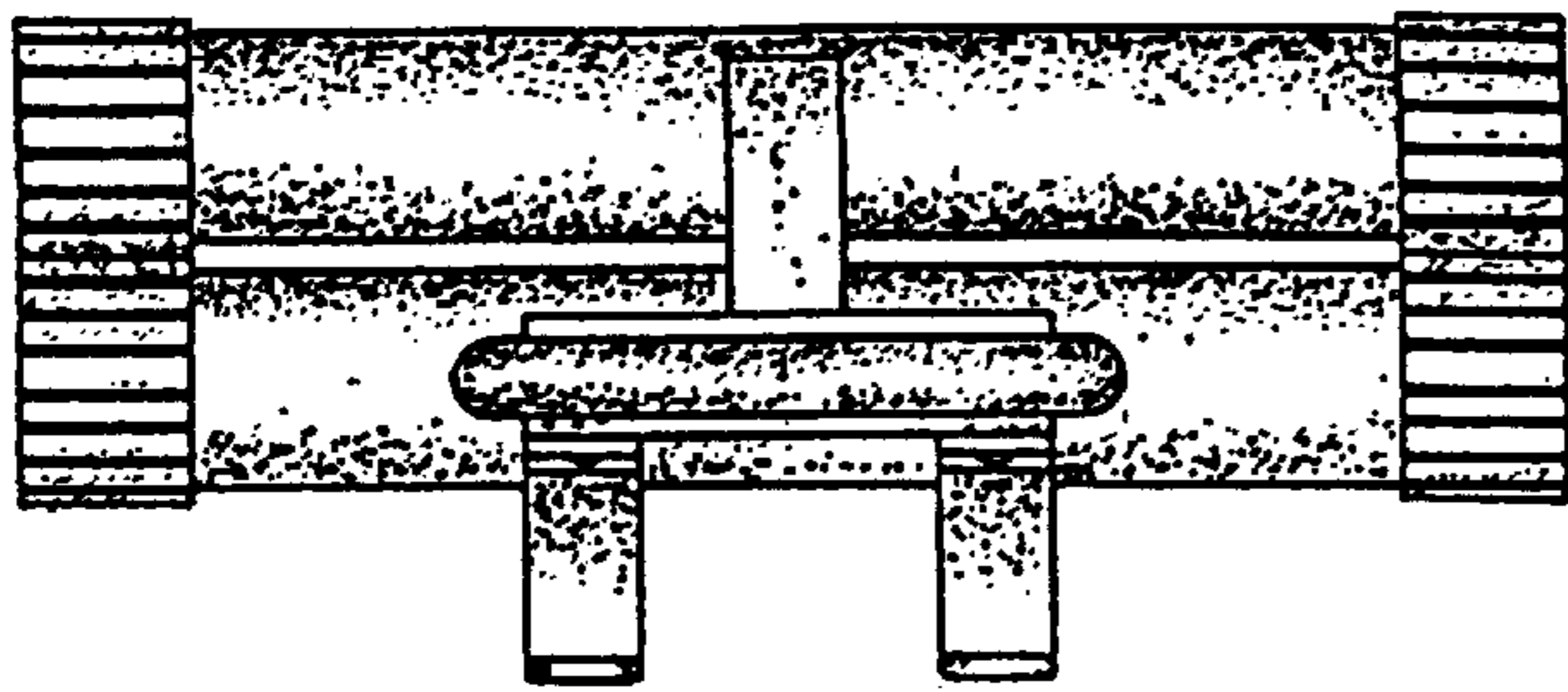

FIG. 4

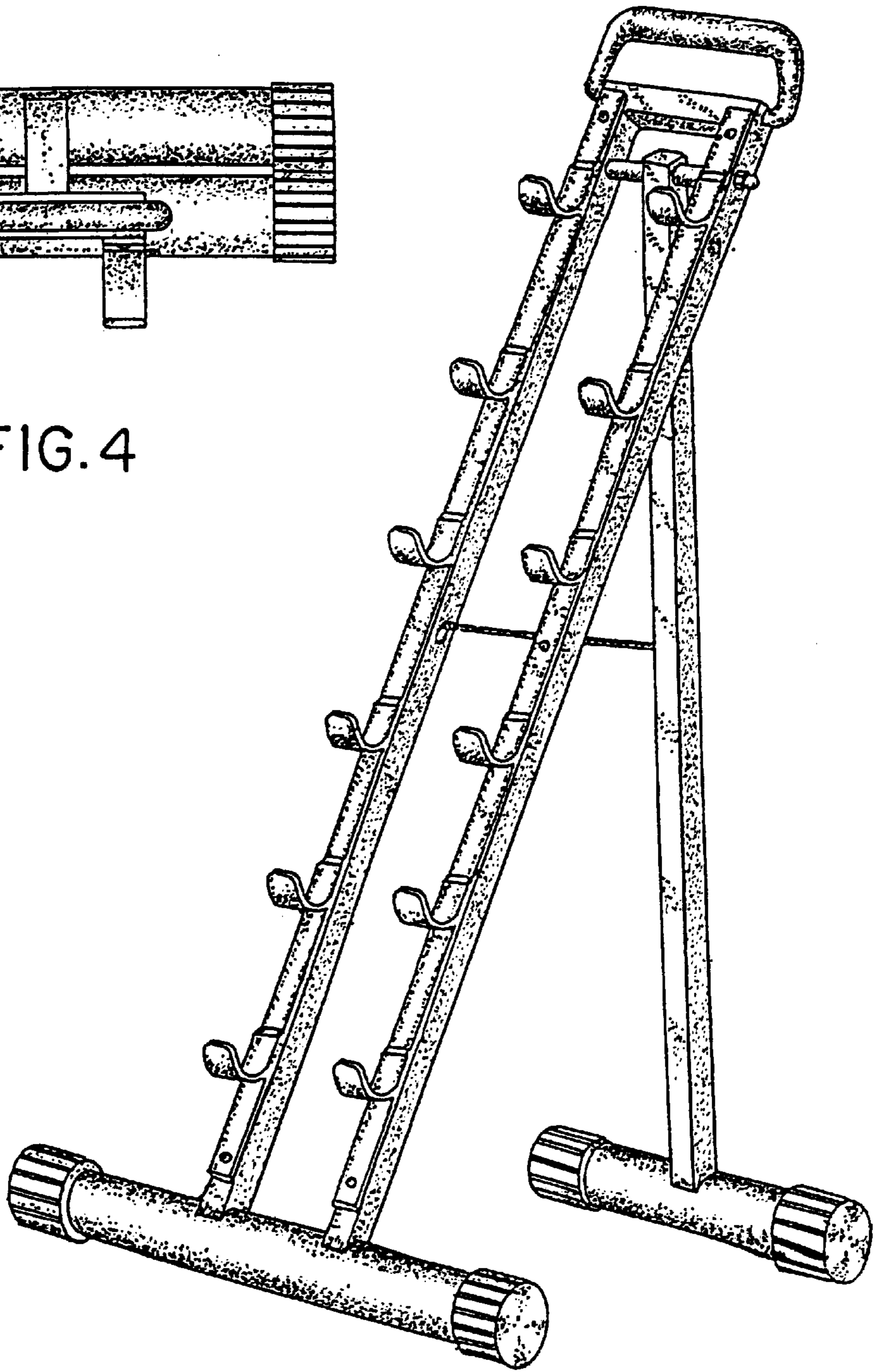

FIG. 1

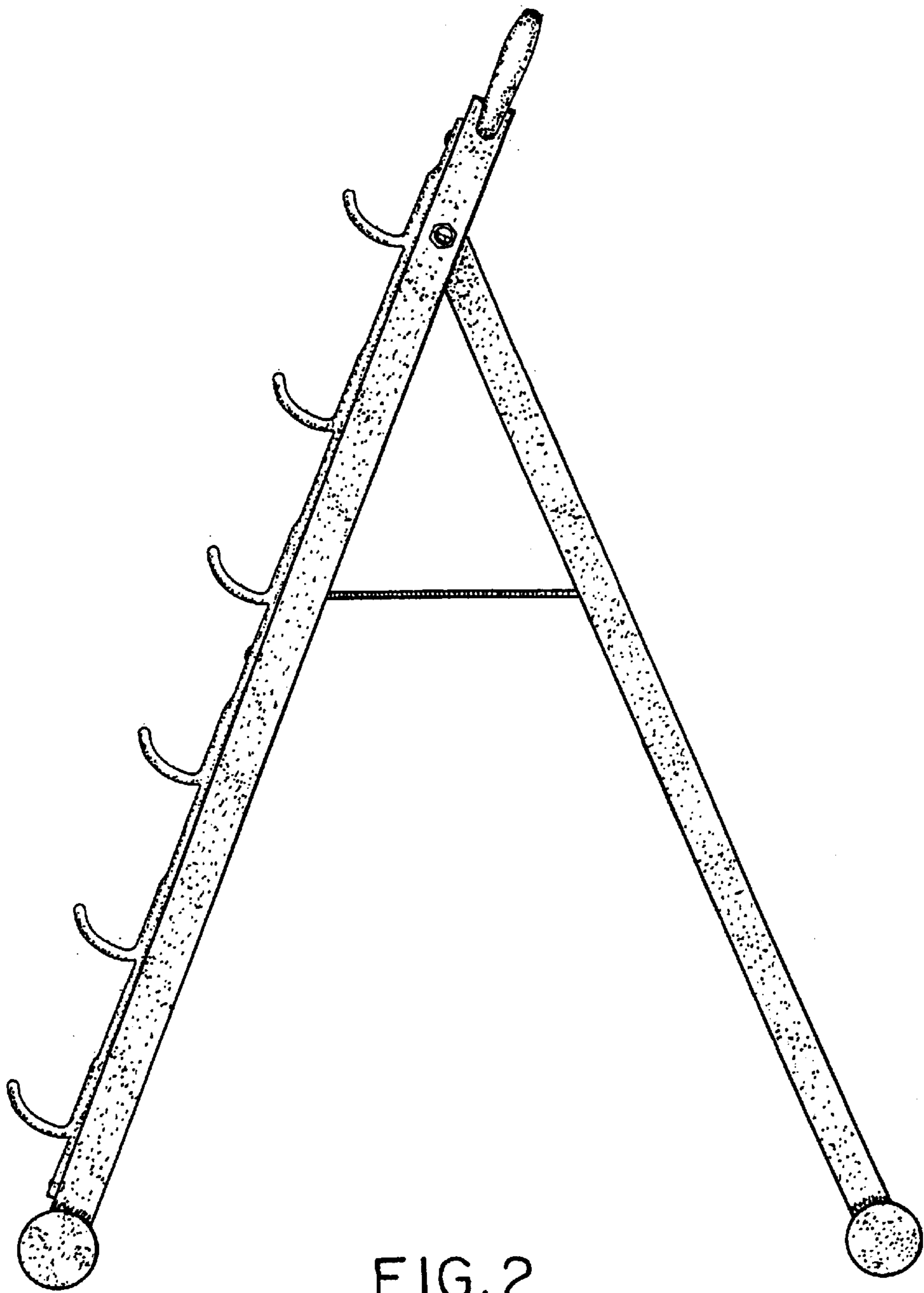

FIG. 2

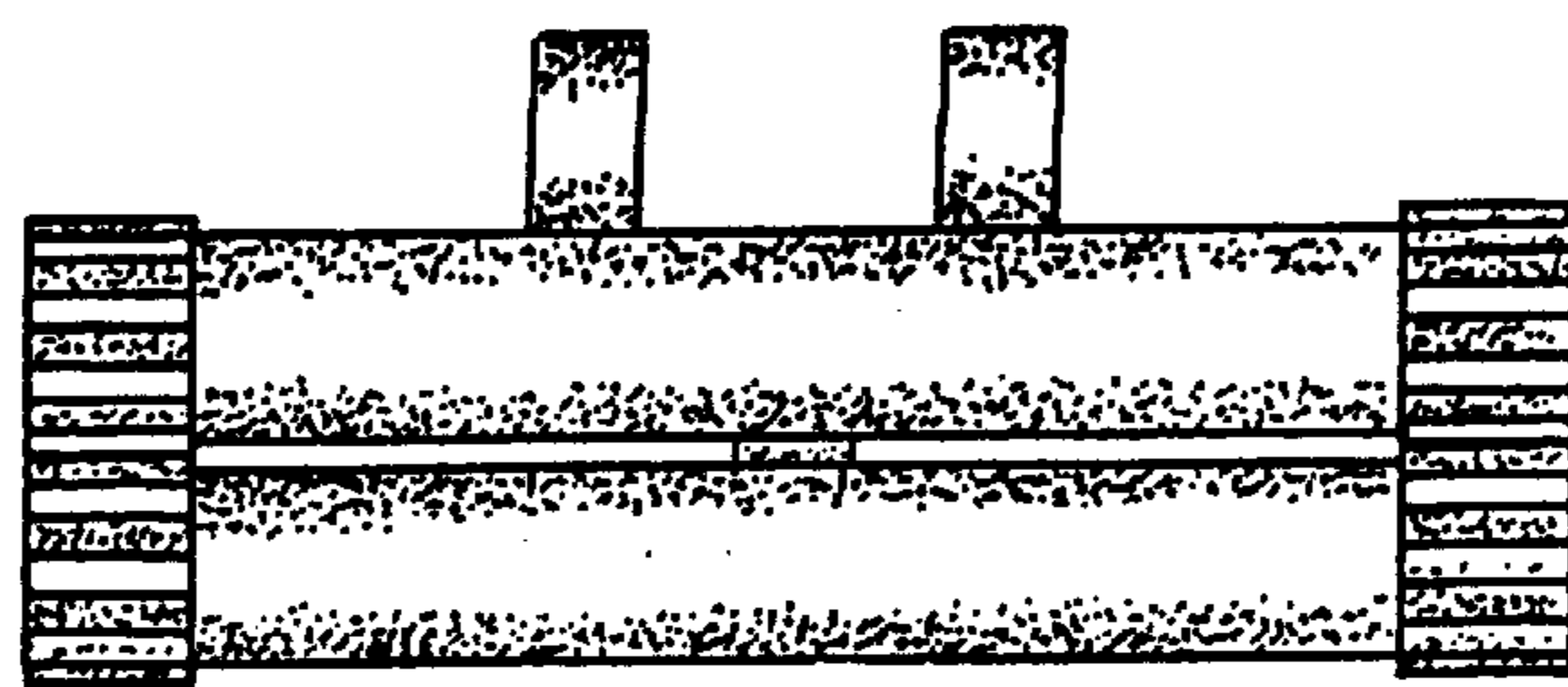

FIG. 5

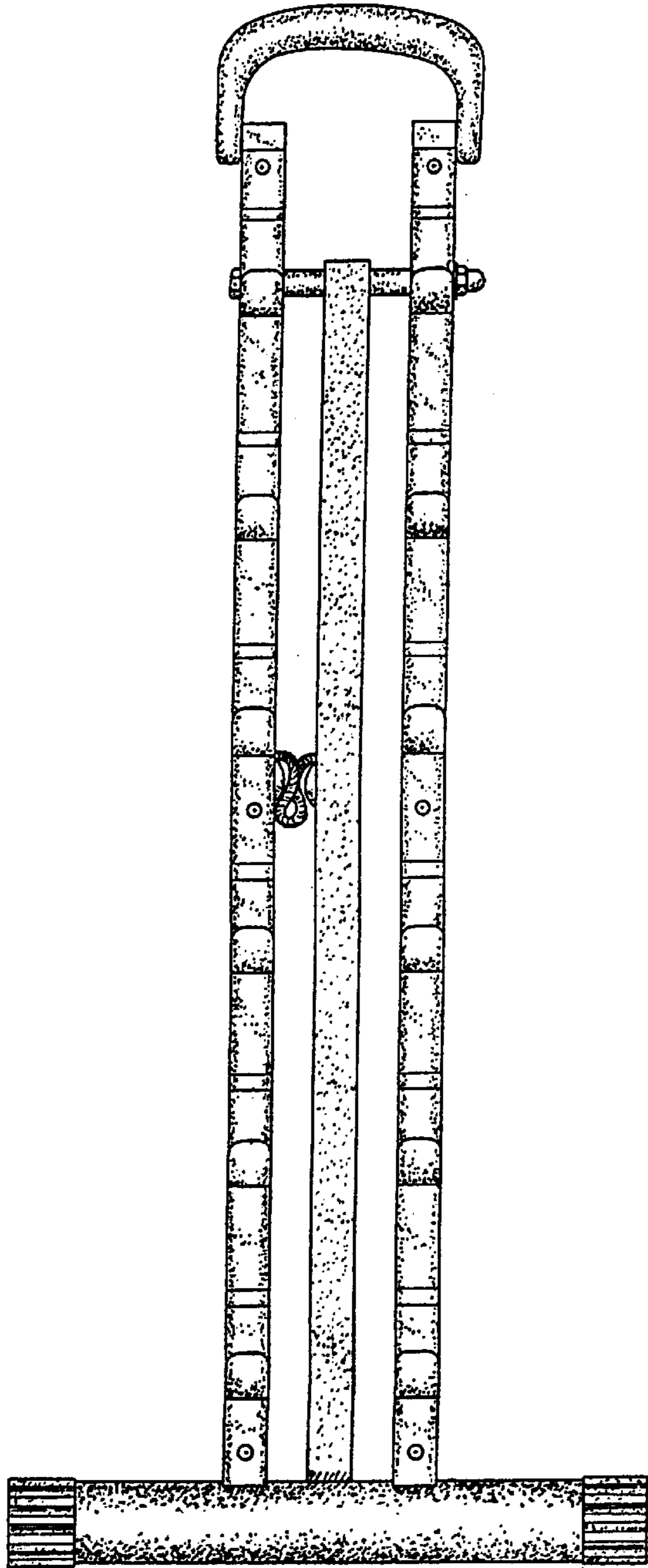

FIG. 3

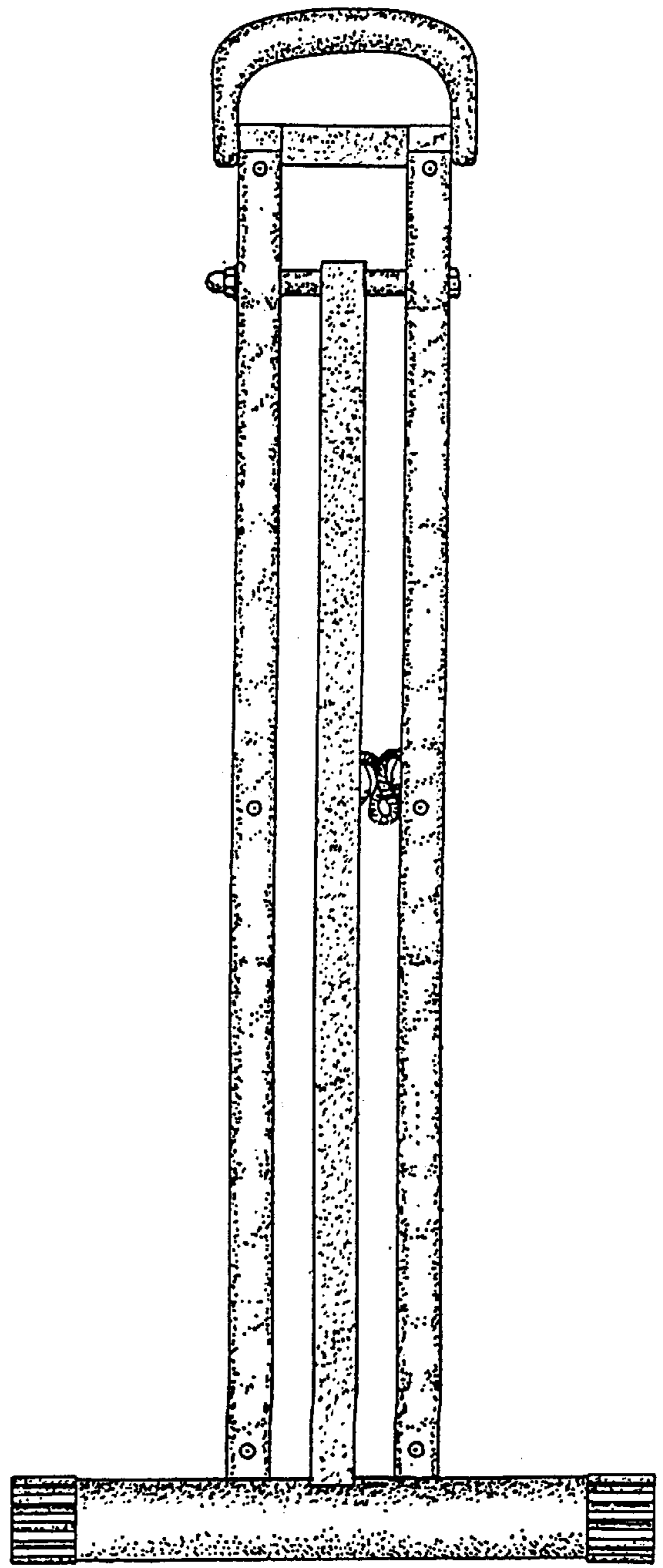

FIG. 6

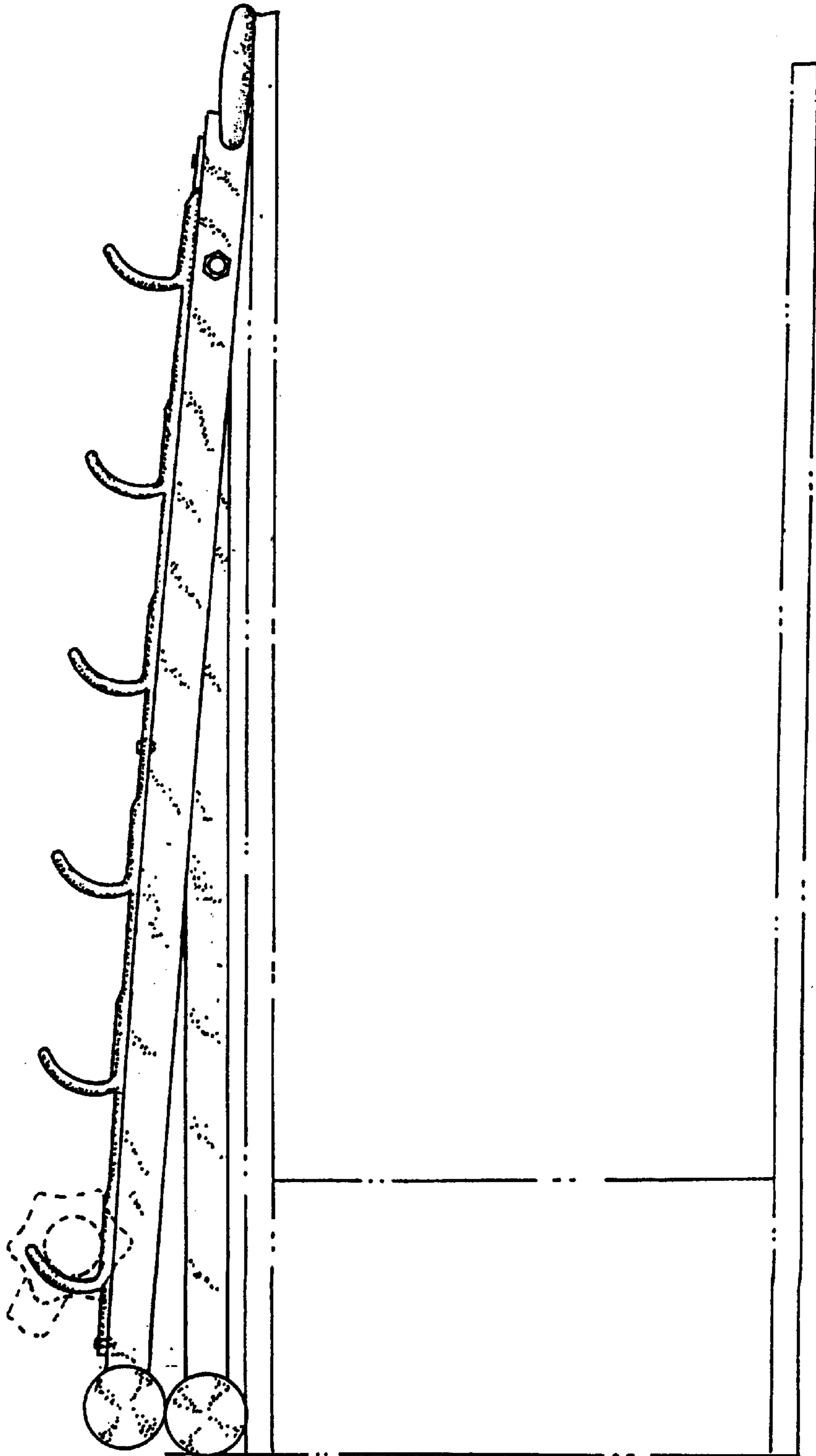

FIG. 7