



US00D424097S

United States Patent [19] Park

[11] **Patent Number: Des. 424,097**

[45] **Date of Patent: ** May 2, 2000**

[54] **NECK ASSEMBLY FOR GUITAR**

[76] Inventor: **In-Jae Park**, 477-7, Toygye-Ri, Hoechon-Eup, Yangju-Gun, Kyonggi-Do, Rep. of Korea

[**] Term: **14 Years**

[21] Appl. No.: **29/102,084**

[22] Filed: **Mar. 17, 1999**

[51] **LOC (7) Cl.** **17-03**

[52] **U.S. Cl.** **D17/20; 84/293**

[58] **Field of Search** D17/14, 15, 18-20; D20/11; 40/299.01; 84/267, 293, 314 R, 315, 485 R

[56] **References Cited**

U.S. PATENT DOCUMENTS

D. 259,199	5/1981	Kelly et al.	D17/14
D. 259,570	6/1981	Hoshino	D17/20
D. 264,477	5/1982	Brent	D17/20
D. 370,939	6/1996	Schaeffler	D17/20
4,119,009	10/1978	Kaman, II	84/293

OTHER PUBLICATIONS

Corel Word Perfect Characters Version 6.1 for Windows. (Brace Character), Apr. 1996.
Guitar Buyers Guide, p.74 (Guild D55 Guitar), 1998-99.

Primary Examiner—Adir Aronovich
Attorney, Agent, or Firm—Dougherty & Associates

[57] **CLAIM**

The ornamental design for a neck assembly for guitar, as shown and described.

DESCRIPTION

FIG. 1 is a perspective view of a neck assembly for guitar, showing my new design;
FIG. 2 is a front view thereof;
FIG. 3 is a rear view thereof;
FIG. 4 is a left side view thereof;
FIG. 5 is a right side view thereof;
FIG. 6 is a top view thereof;
FIG. 7 is a bottom view thereof; and,
FIG. 8 is an enlarged front view of the head of neck assembly, the neck portion is omitted for ease of illustration.

1 Claim, 4 Drawing Sheets

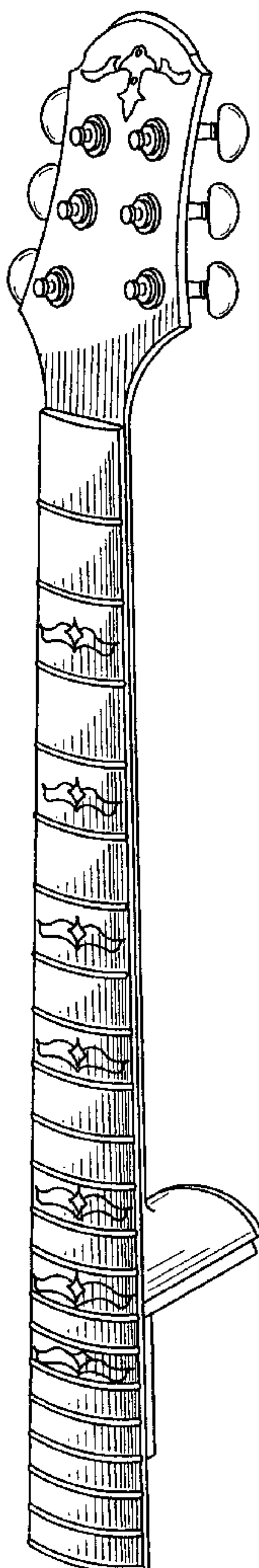

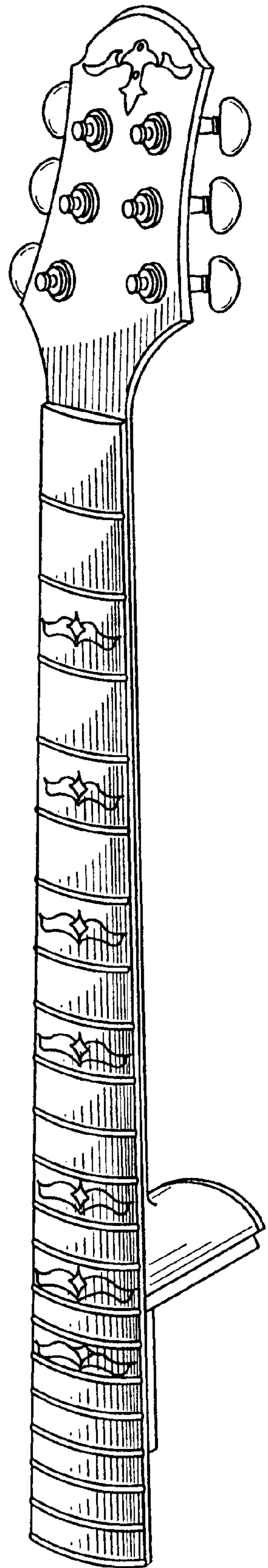

Fig. 1

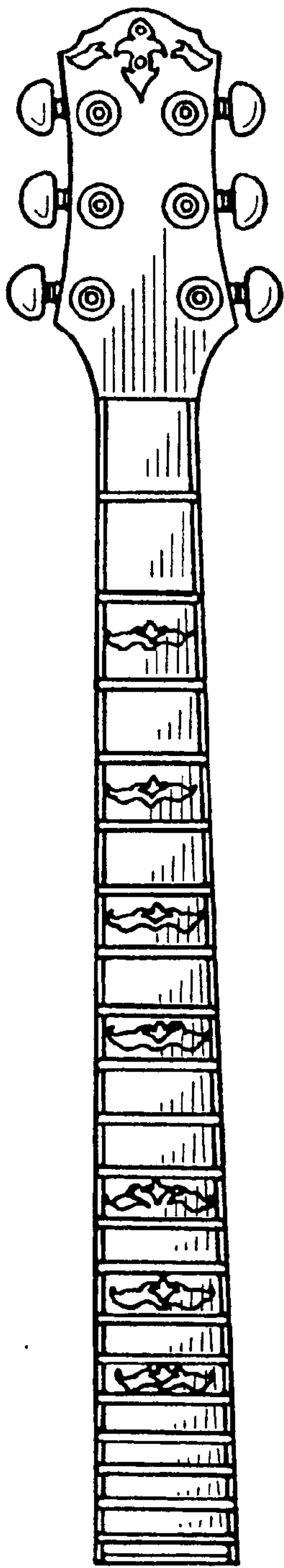

Fig. 2

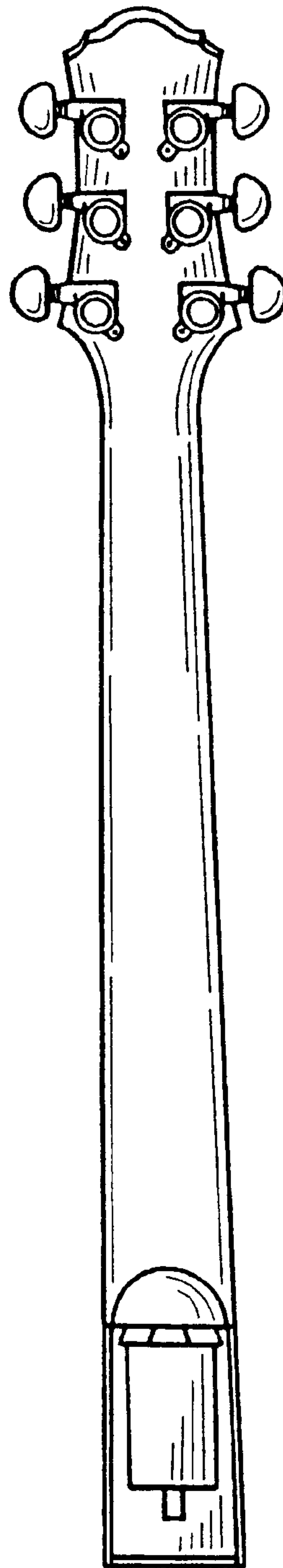

Fig. 3

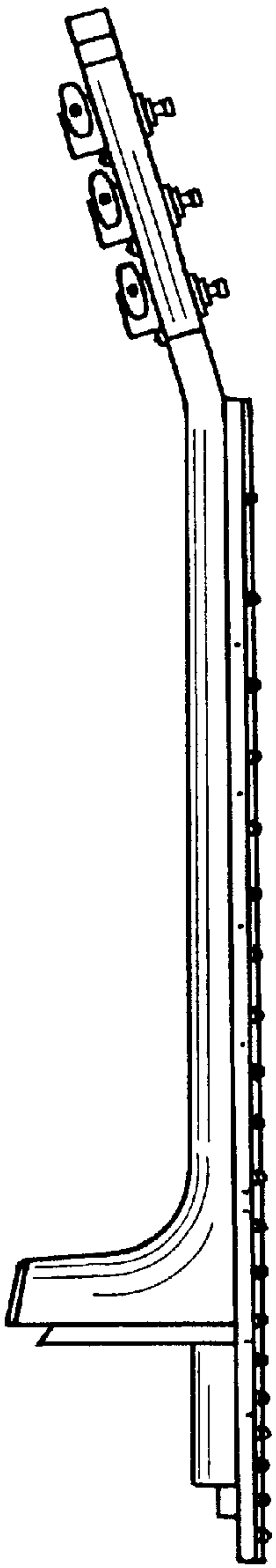

Fig. 4

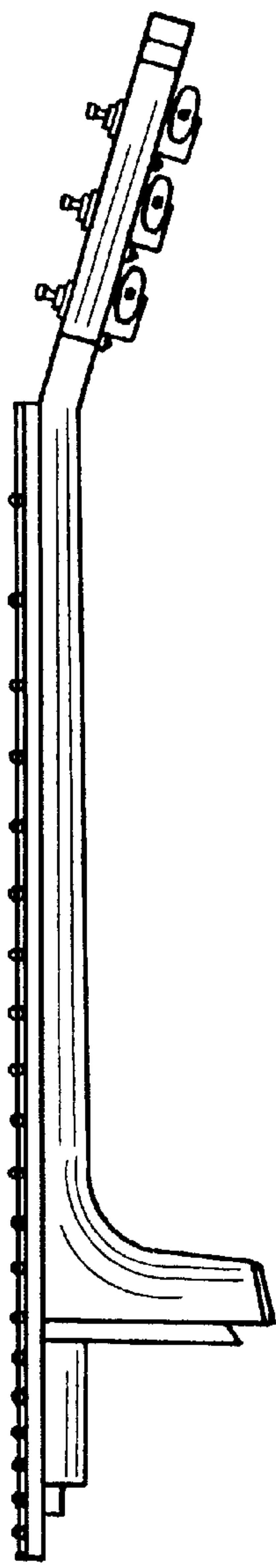

Fig. 5

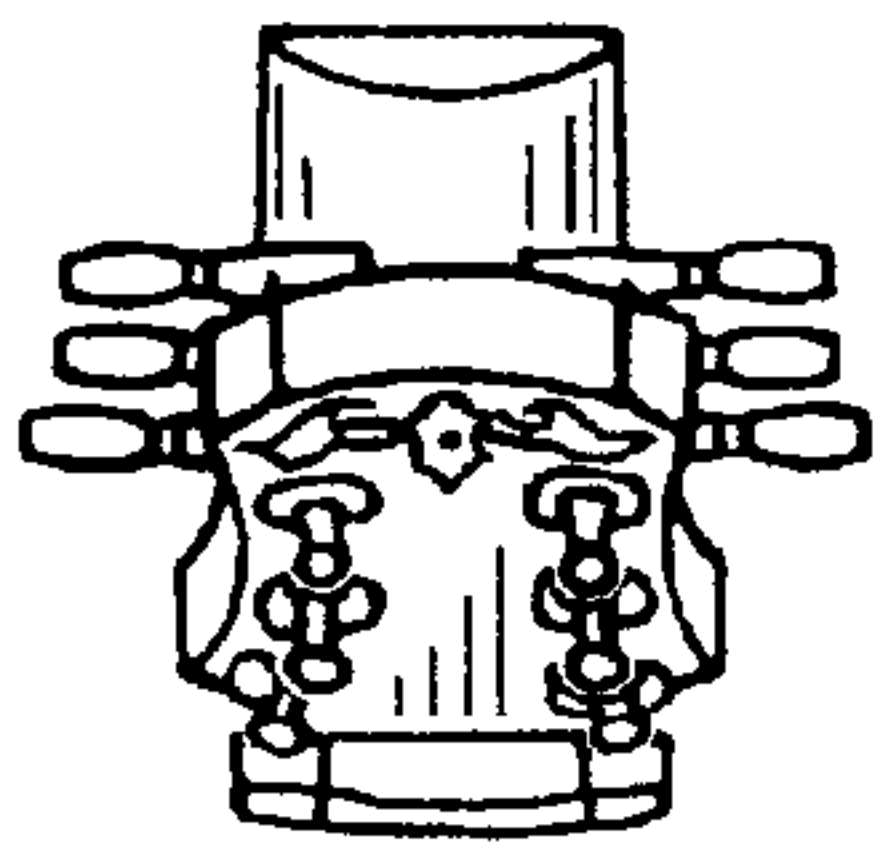

Fig. 6

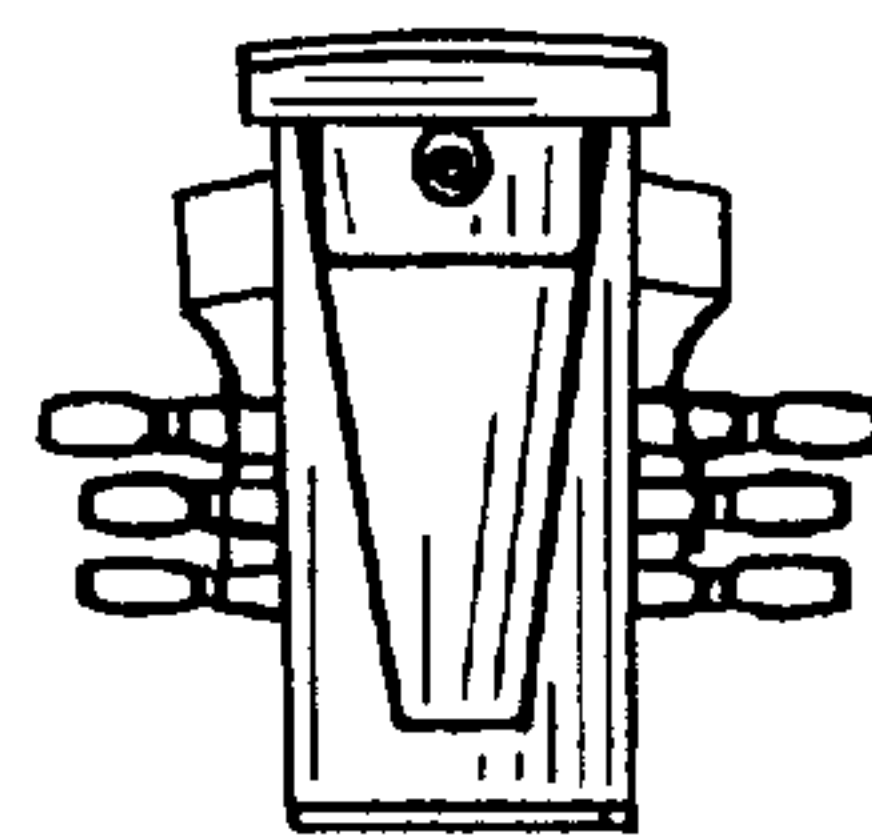

Fig. 7

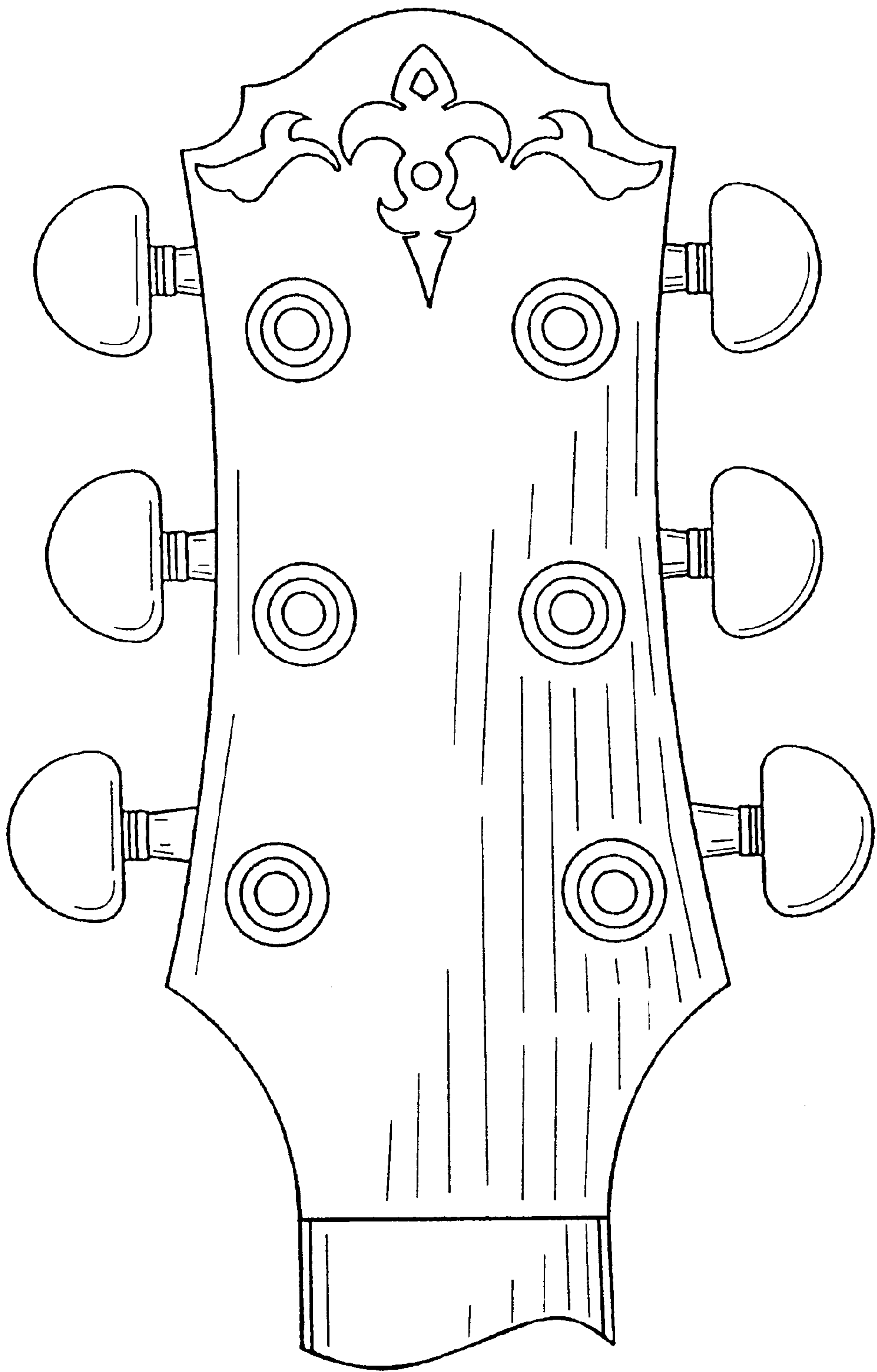

Fig. 8