



US00D424022S

**United States Patent** [19]  
**Polzehl**

[11] **Patent Number: Des. 424,022**

[45] **Date of Patent: \*\* May 2, 2000**

[54] **SURGE ARRESTER MAGAZINE**

[75] Inventor: **Heiko Polzehl**, Berlin, Germany

[73] Assignee: **Krone Aktiengesellschaft**, Berlin, Germany

[\*\*] Term: **14 Years**

[21] Appl. No.: **29/090,800**

[22] Filed: **Jul. 14, 1998**

[30] **Foreign Application Priority Data**

Mar. 17, 1998 [DE] Germany ..... M 9802847  
Mar. 17, 1998 [DE] Germany ..... M 9802851

[51] **LOC (7) Cl.** ..... **13-03**

[52] **U.S. Cl.** ..... **D13/178; D13/160**

[58] **Field of Search** ..... **D13/147, 160, D13/178; 361/117, 127**

[56] **References Cited**

**U.S. PATENT DOCUMENTS**

D. 325,725 4/1992 Yamagata et al. .... D13/160  
D. 390,828 2/1998 Aramaki ..... D13/147  
3,447,118 5/1969 Ferree ..... 361/117  
5,172,295 12/1992 Hegner et al. .... 361/117

*Primary Examiner*—Adir Aronovich  
*Attorney, Agent, or Firm*—McGlew and Tuttle, P.C.

[57] **CLAIM**

The ornamental design for a surge arrester magazine, as shown and described.

**DESCRIPTION**

FIG. 1 is a front view of a surge arrester magazine showing my new design;

FIG. 2 is a right side view of the design of the present invention;

FIG. 3 is a top plan view of the design of the present invention;

FIG. 4 is a left side view of the design of the present invention;

FIG. 5 is a back view of the design of the present invention;

FIG. 6 is a bottom view of the design of the present invention;

FIG. 7 is a front right top perspective view of the design of the present invention;

FIG. 8 is a front view of the present invention with the front cover removed; and,

FIG. 9 is a front right top perspective view of the design of the present invention with the cover removed.

**1 Claim, 5 Drawing Sheets**

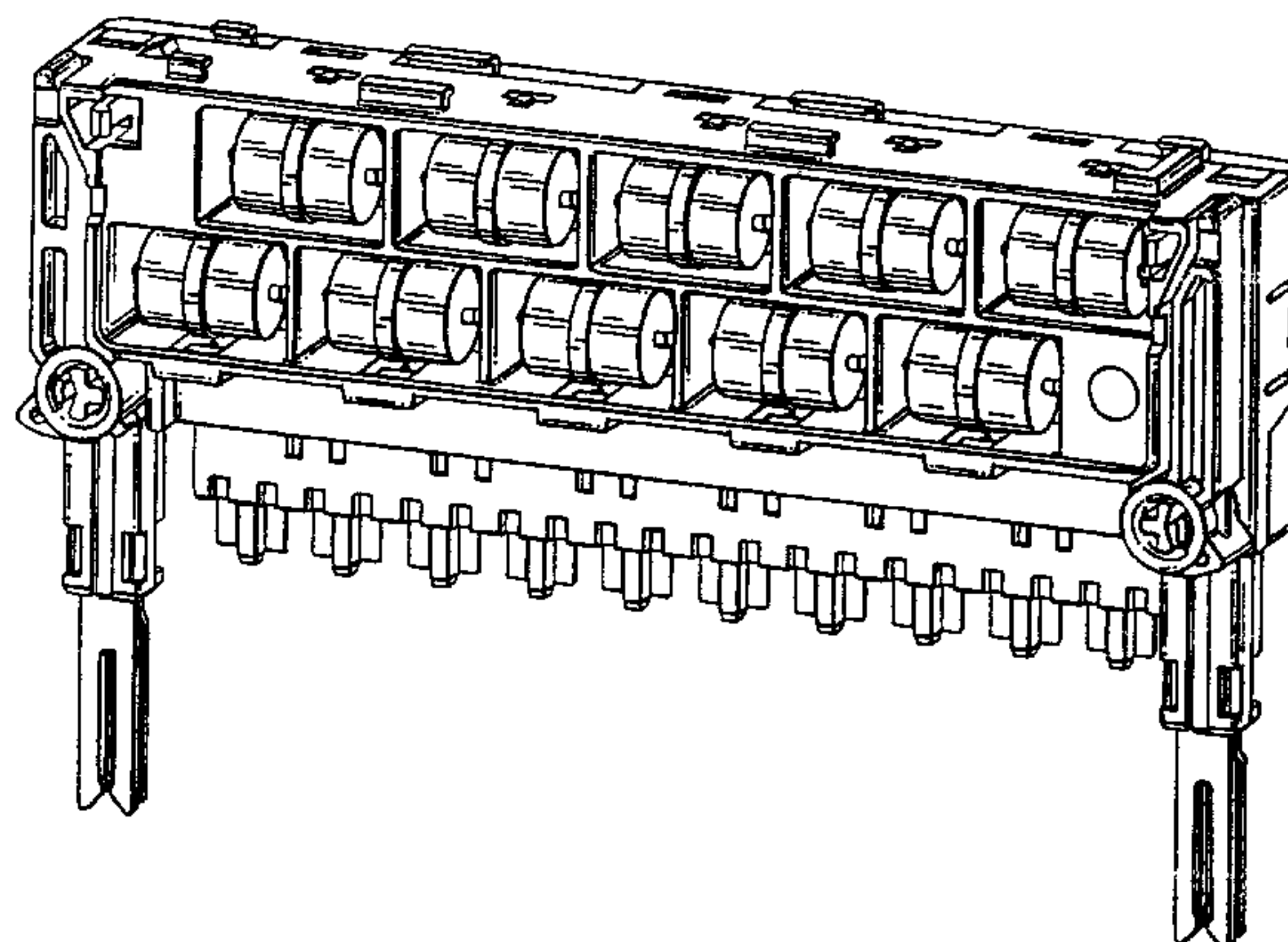
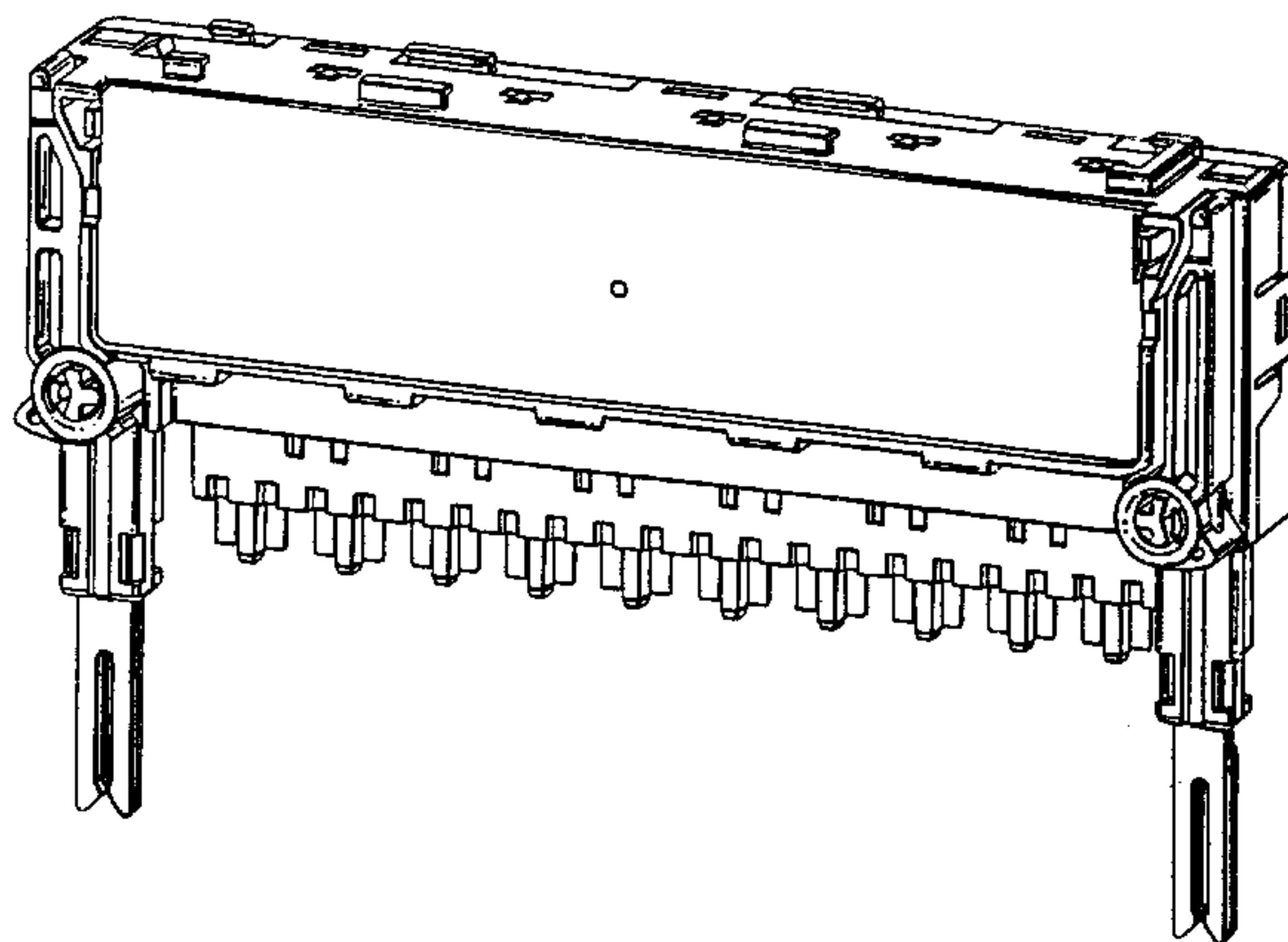

FIG.1

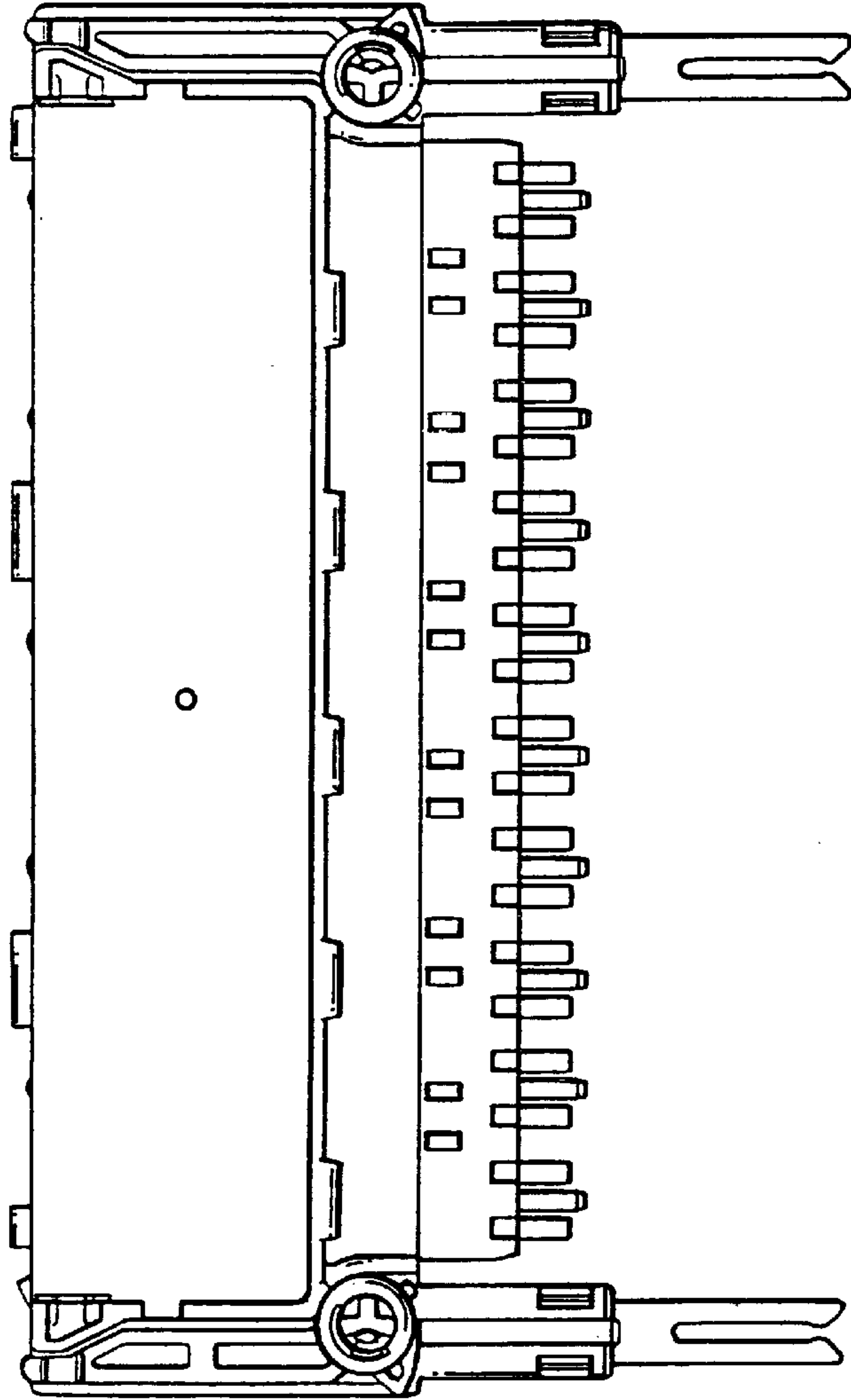

FIG.2

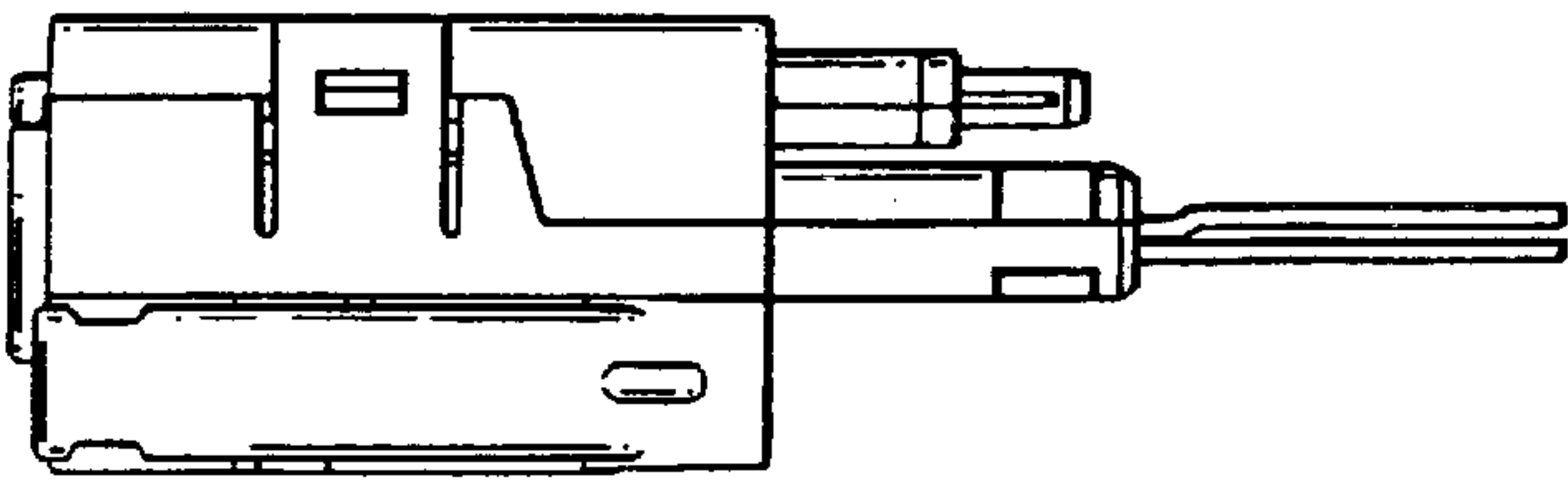

FIG.3

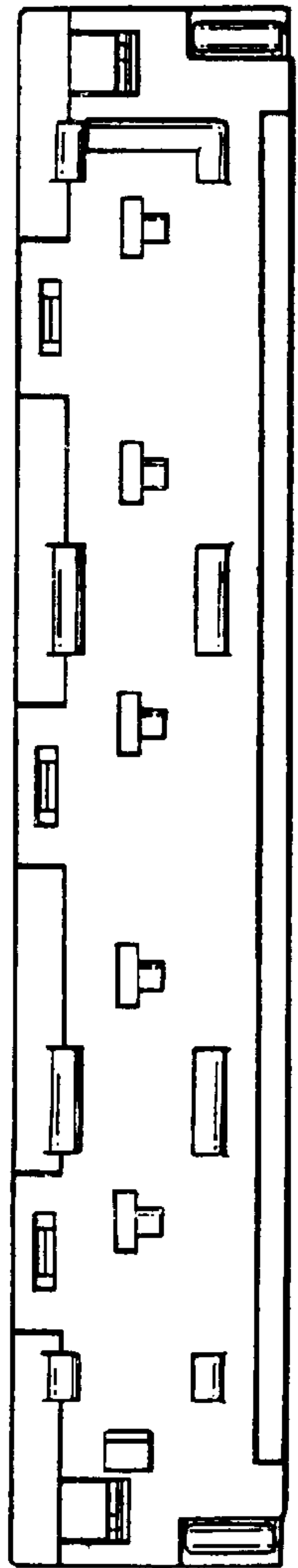

FIG.6

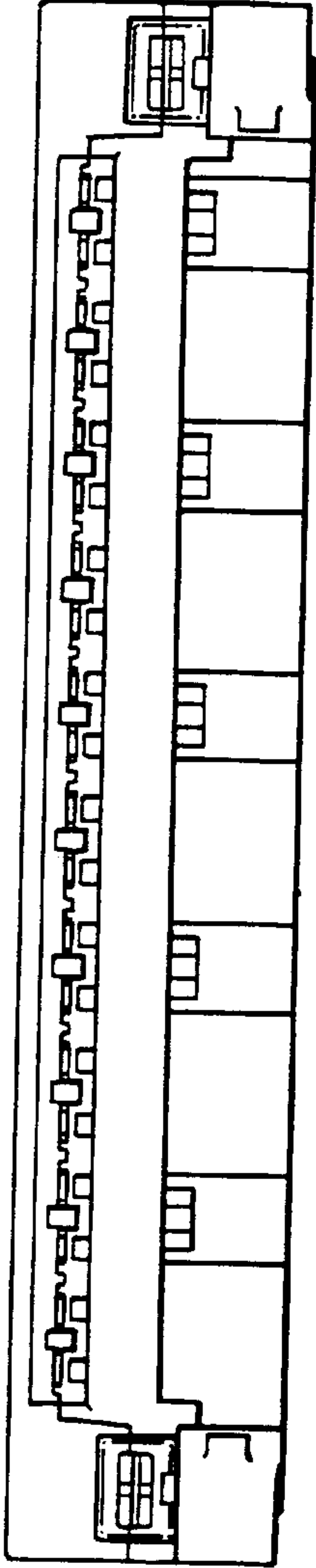

FIG.5

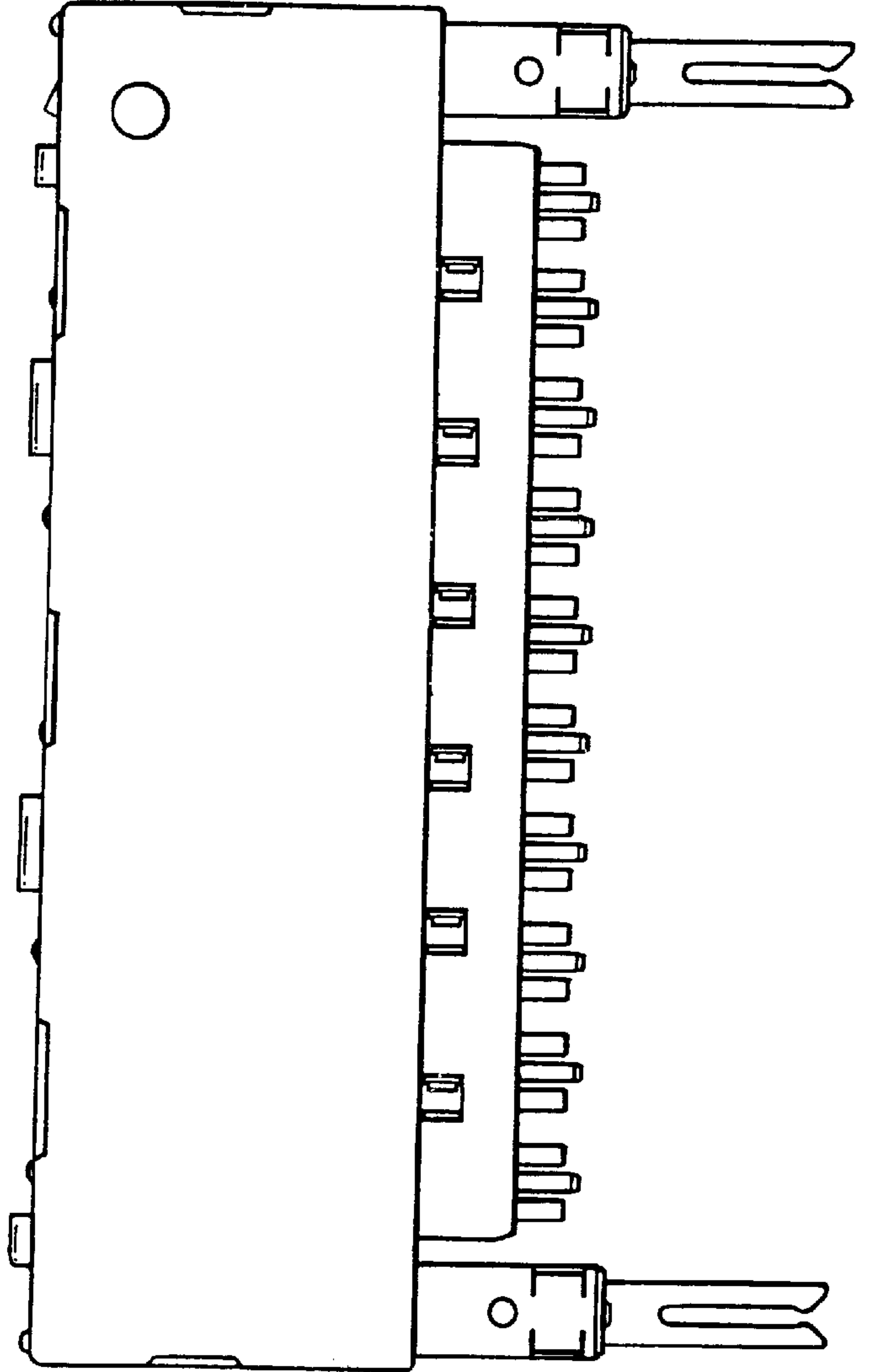

FIG.4

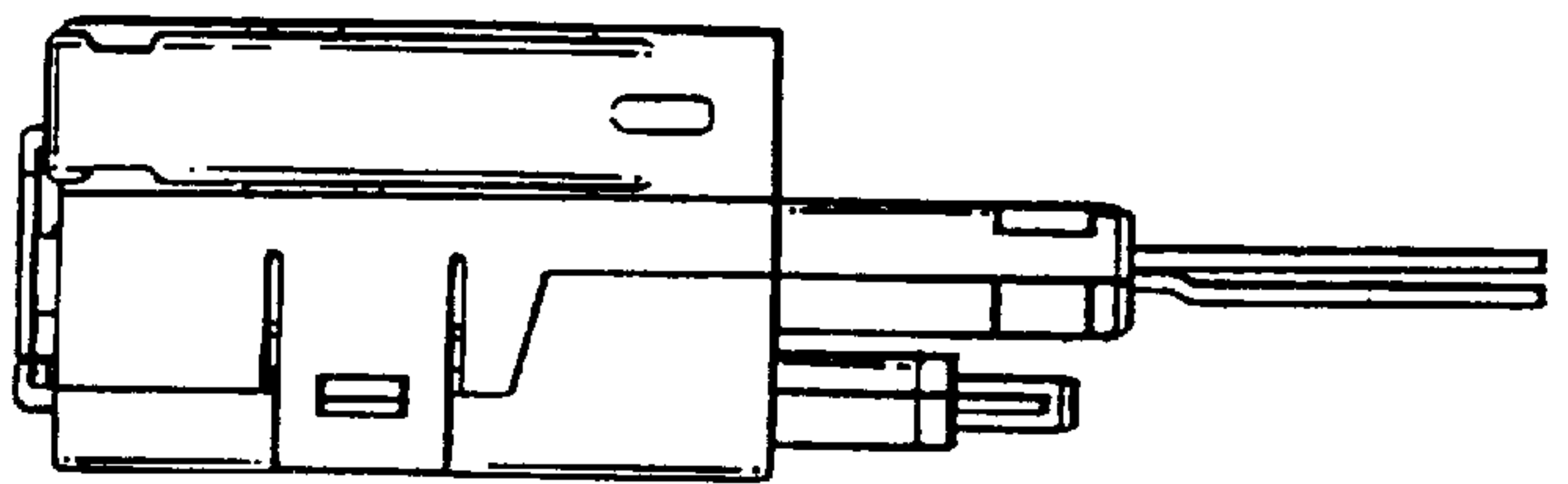

FIG. 7

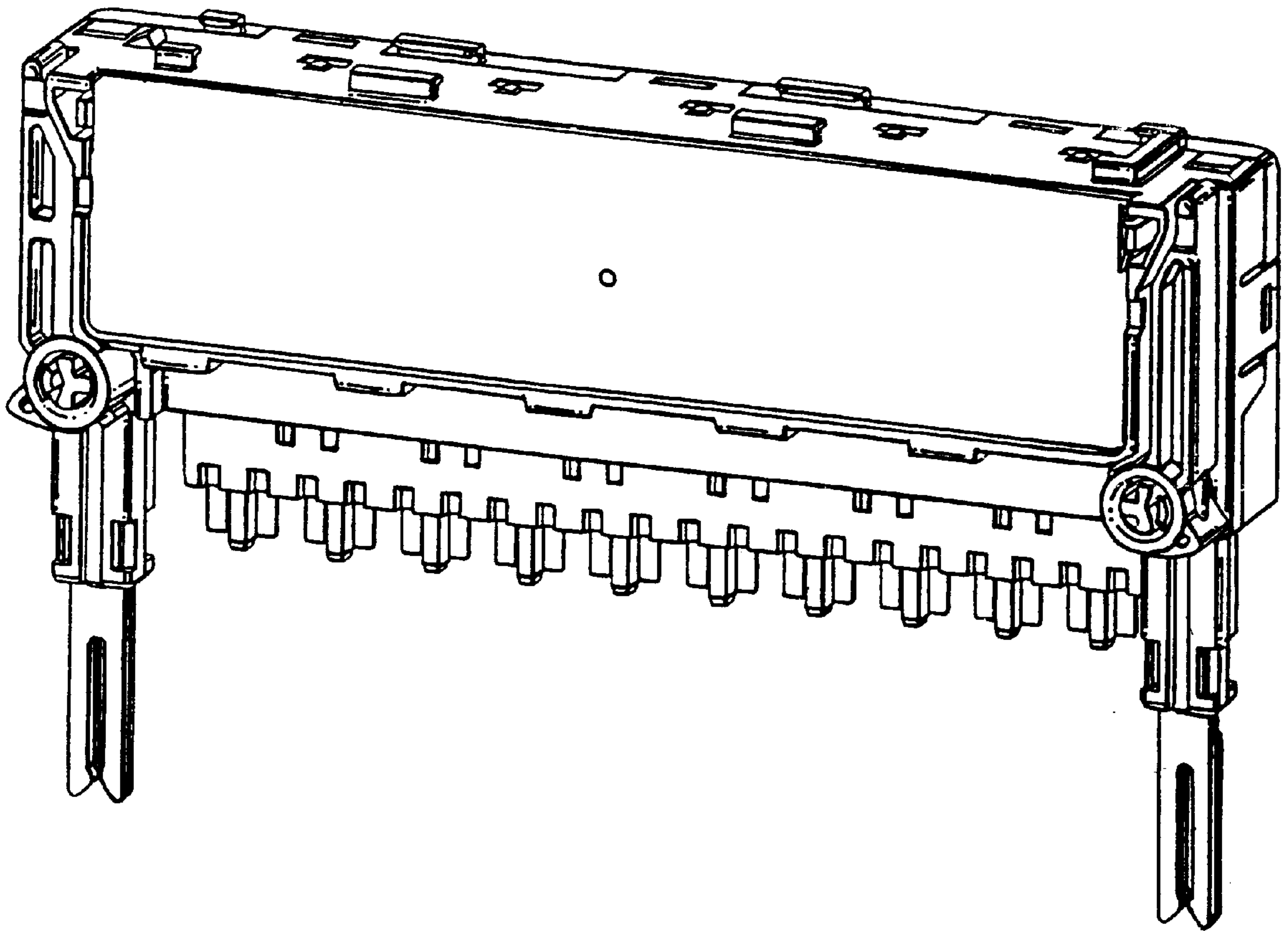

FIG. 8

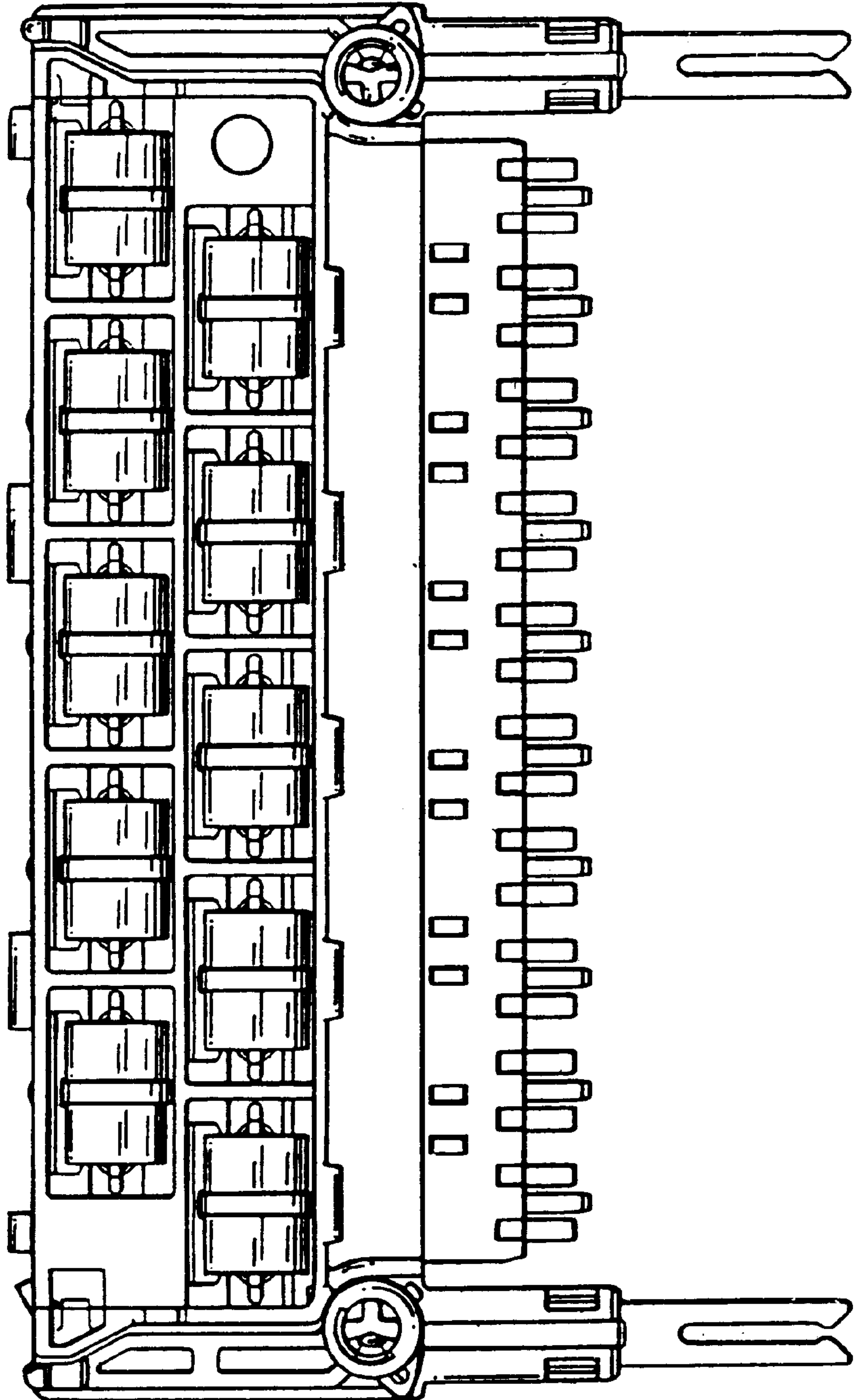



FIG. 9

