



US00D424016S

# United States Patent [19]

[11] Patent Number: Des. 424,016

Gipson et al.

[45] Date of Patent: \*\* May 2, 2000

[54] THERMOCOUPLE AND RTD CONNECTOR

[75] Inventors: Mark K. Gipson, Fox Lake, Ill.; Steven K. Klingemann, Mt. Horeb, Wis.; Jason J. Alvarez, Chicago; Shawn O. Barrett, Grayslake, both of Ill.; Arthur O. Volbrecht, Genoa City, Wis.

[73] Assignee: Watlow Electric Manufacturing Company, St. Louis, Mo.

[\*\*] Term: 14 Years

[21] Appl. No.: 29/090,697

[22] Filed: Jul. 14, 1998

[51] LOC (7) Cl. .... 13-03

[52] U.S. Cl. .... D13/133

[58] Field of Search ..... D13/133; D10/52; 374/179, 180, 181, 182, 194; 439/620, 913; 136/235

[56] References Cited

U.S. PATENT DOCUMENTS

D. 331,907	12/1992	Hollander et al. .	
D. 331,908	12/1992	Hollander et al. .	
D. 331,909	12/1992	Hollander et al. .	
D. 332,083	12/1992	Hollander et al. .	
D. 332,084	12/1992	Hollander et al. .	
D. 340,910	11/1993	Hollander et al. .	
D. 349,275	8/1994	Hollander .	
3,609,655	9/1971	Tymkewwicz .....	439/913
3,855,569	12/1974	Tymkewwicz .....	439/913
4,484,018	11/1984	McLynn .....	139/235 X
4,746,298	5/1988	Hollander .....	439/913

4,834,677	5/1989	Archang .....	439/913
5,167,519	12/1992	Jones et al. ....	136/235 X
5,183,420	2/1993	Hollander .....	D13/133 X
5,833,496	11/1998	Hollander et al. ....	439/620

Primary Examiner—Joel Sincavage  
Attorney, Agent, or Firm—Herzog, Crebs & McGhee, LLP

[57] CLAIM

The ornamental design of a thermocouple and RTD connector, as shown and described.

DESCRIPTION

FIG. 1 is a front isometric view of the male portion of the connector showing our new design;  
 FIG. 2 is a rear isometric view thereof;  
 FIG. 3 is a top plan view thereof;  
 FIG. 4 is a rear elevation view thereof;  
 FIG. 5 is a front elevation view thereof;  
 FIG. 6 is a side elevation view thereof;  
 FIG. 7 is a bottom plan view thereof;  
 FIG. 8 is a front isometric view of the female portion of the connector showing our new design;  
 FIG. 9 is a rear isometric view thereof;  
 FIG. 10 is a top plan view thereof;  
 FIG. 11 is a rear elevation view thereof;  
 FIG. 12 is a front elevation view thereof;  
 FIG. 13 is a side elevation view thereof;  
 FIG. 14 is a bottom plan view thereof;  
 FIG. 15 is a front isometric view of the connected male and female portions of the connector showing our new design; and,  
 FIG. 16 is a front isometric view of the disconnected male and female portions of the connector showing our new design.

1 Claim, 7 Drawing Sheets

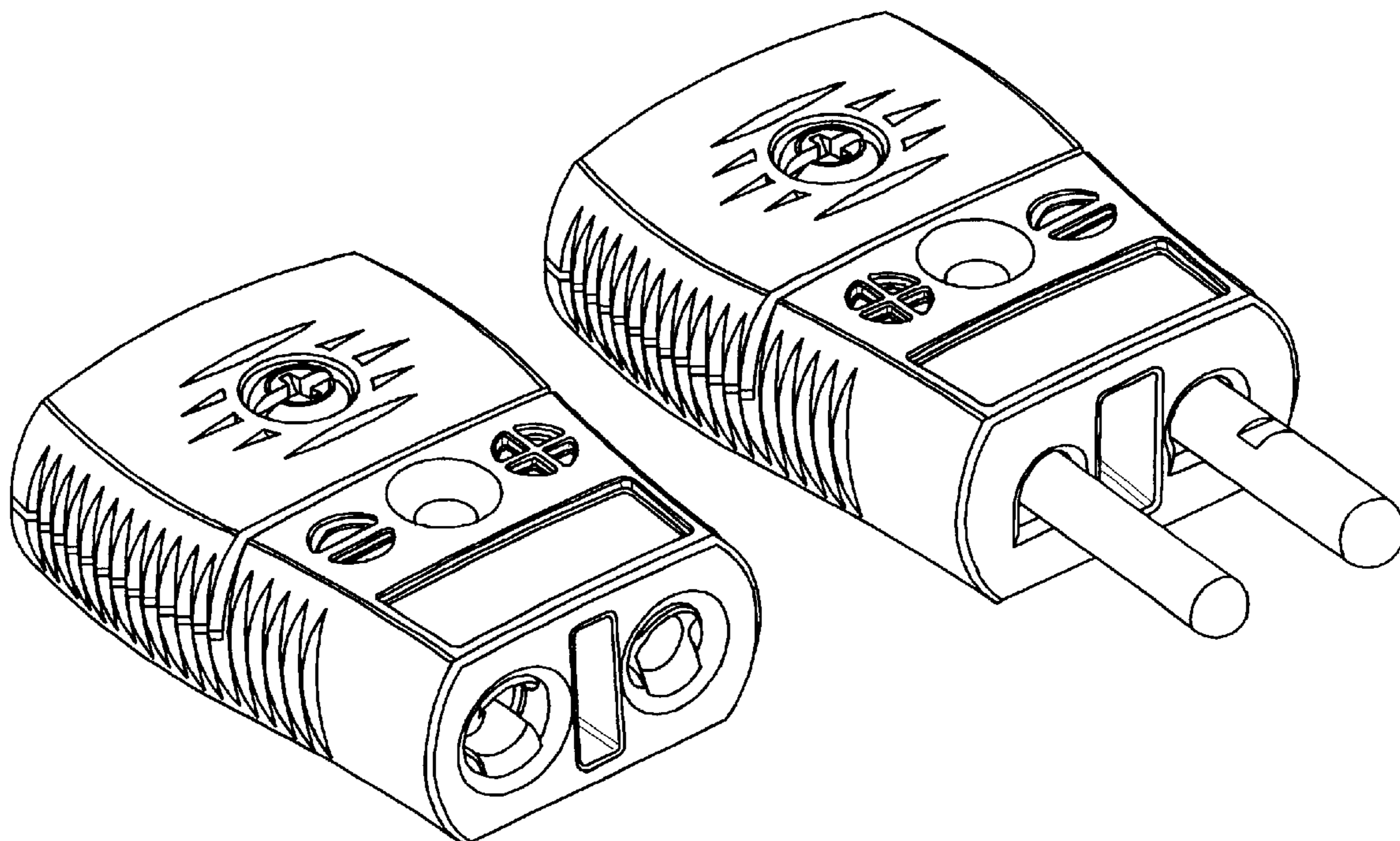

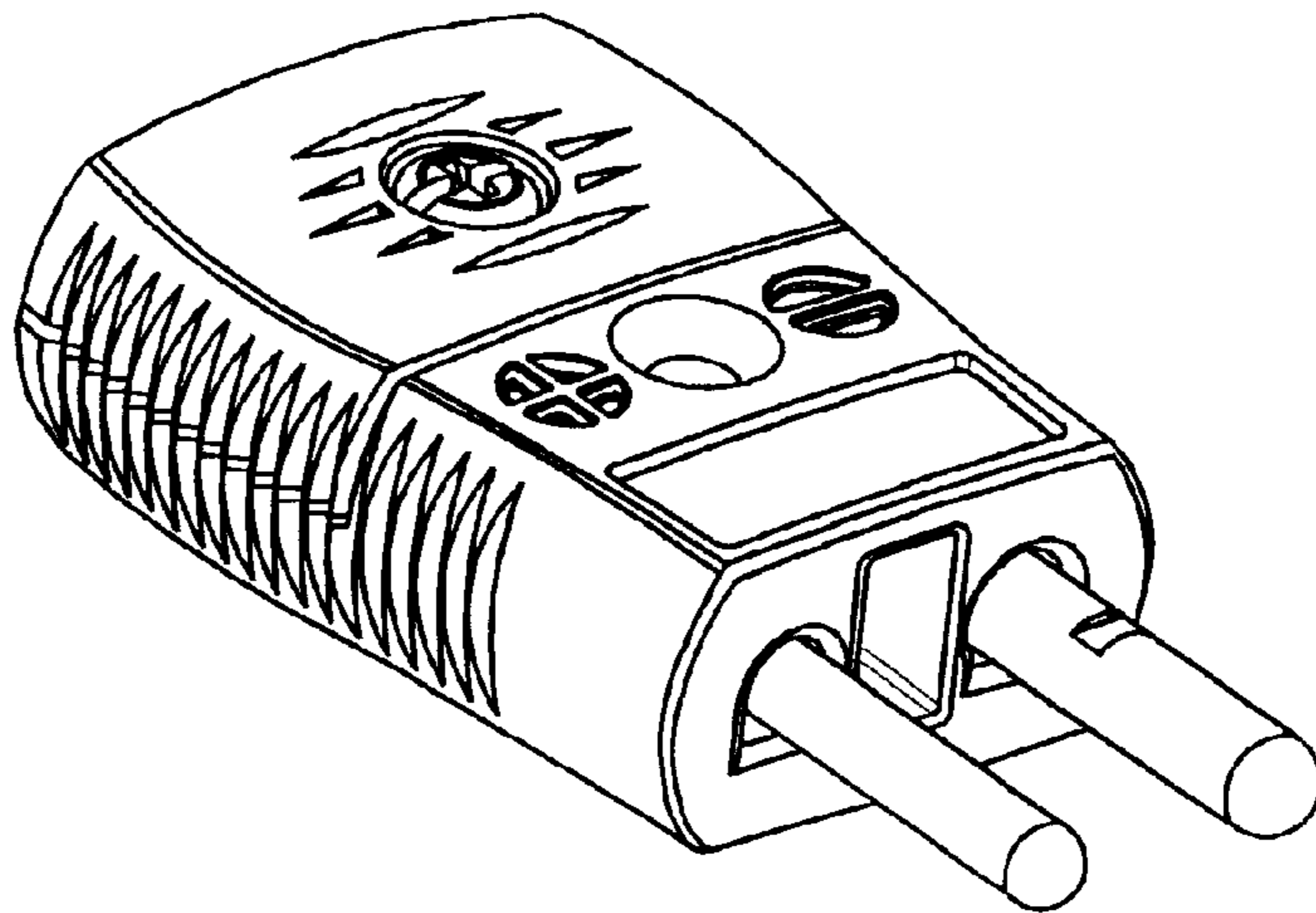

FIG. 1

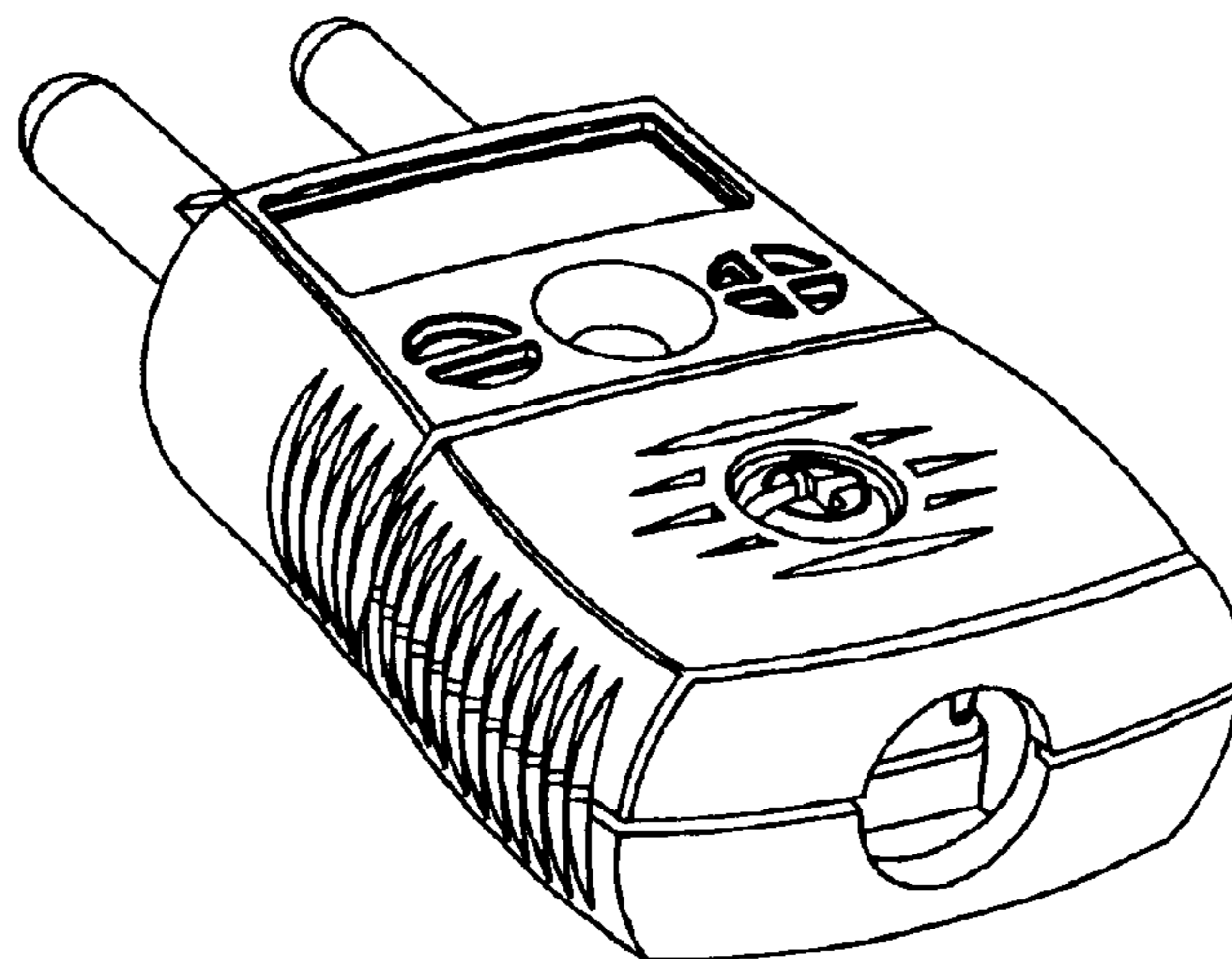

FIG. 2

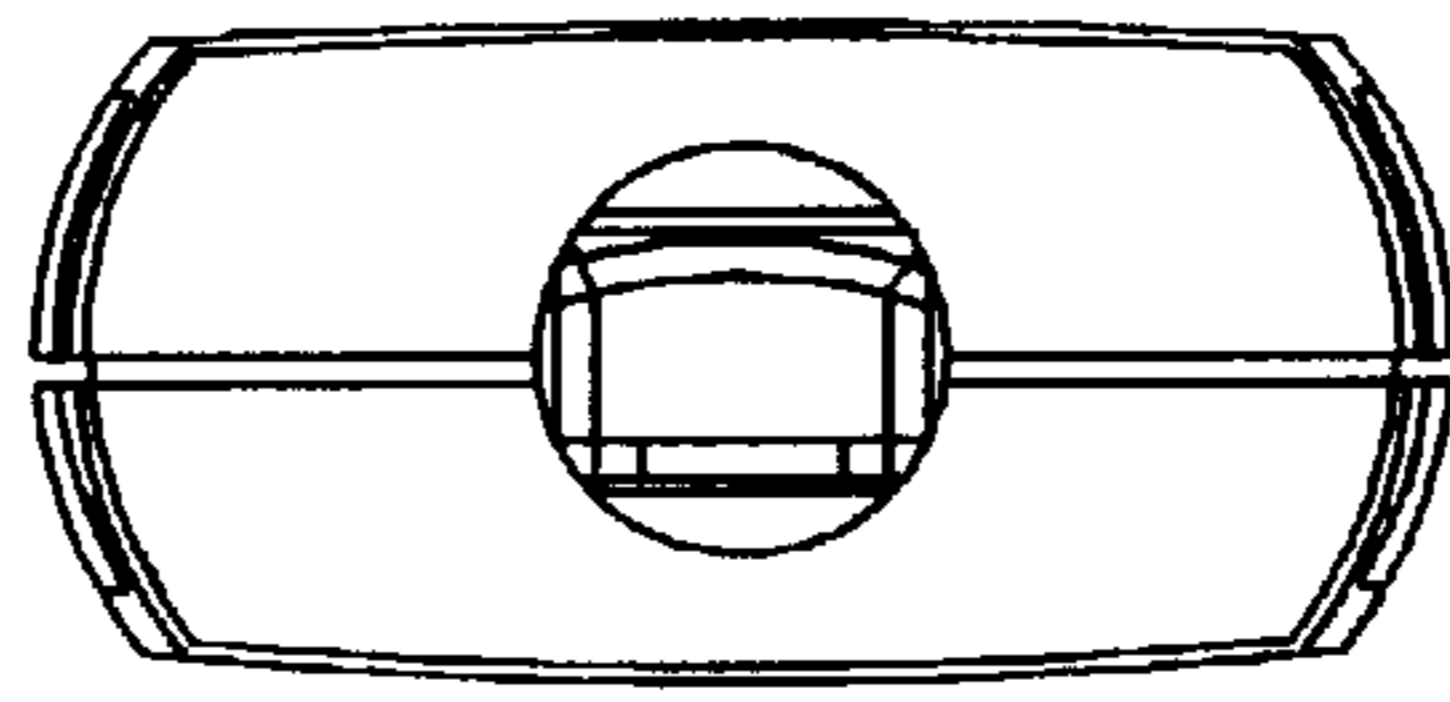

FIG. 4

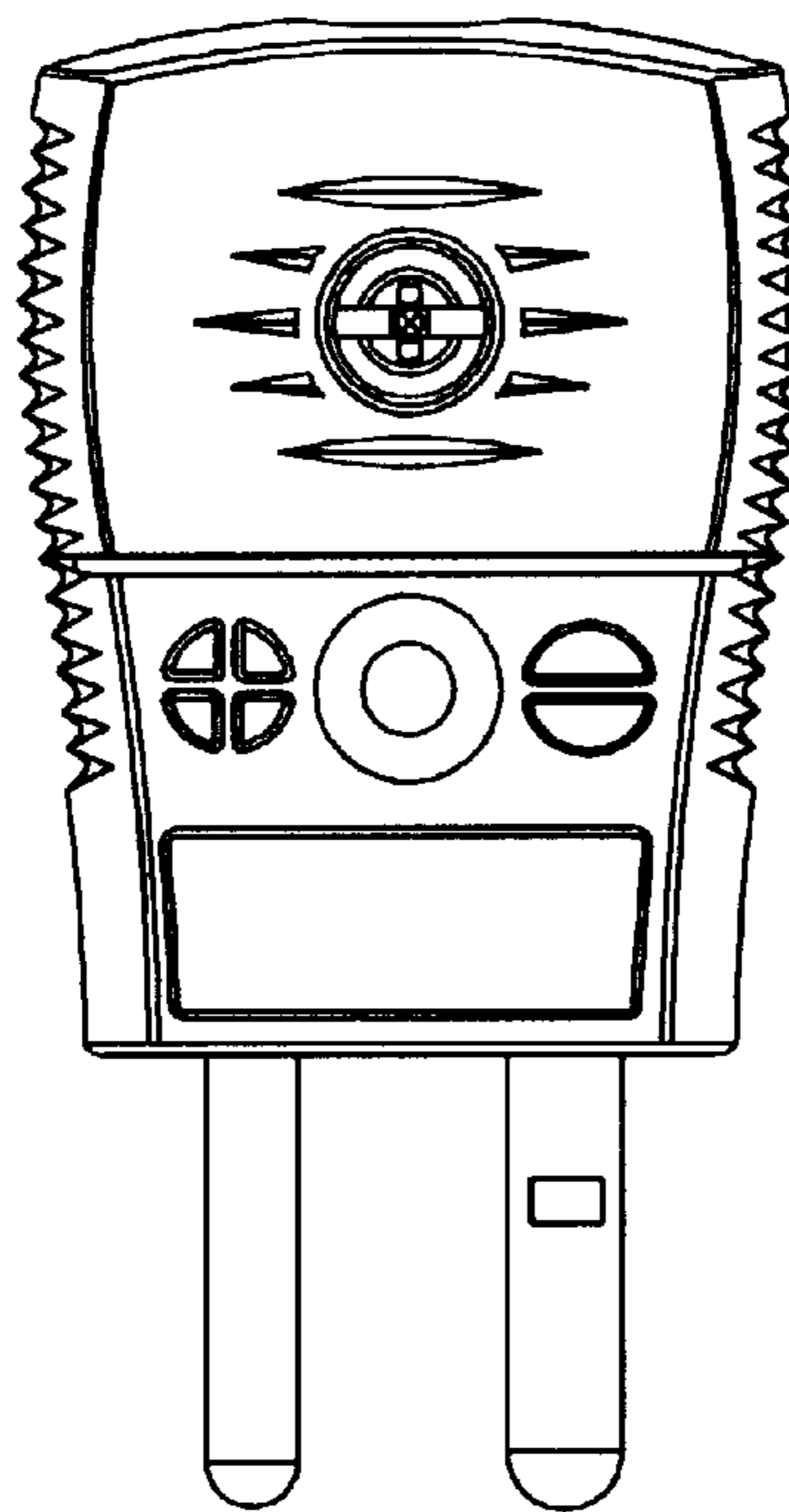

FIG. 3

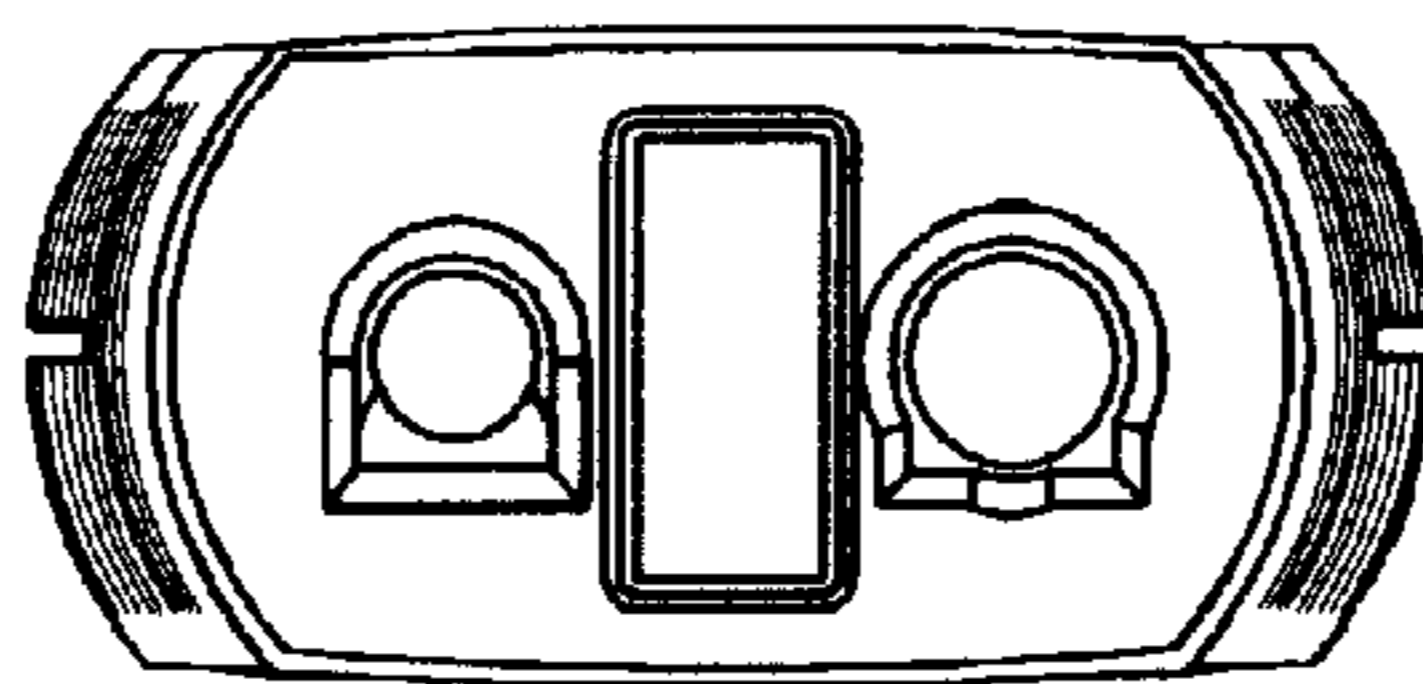

FIG. 5

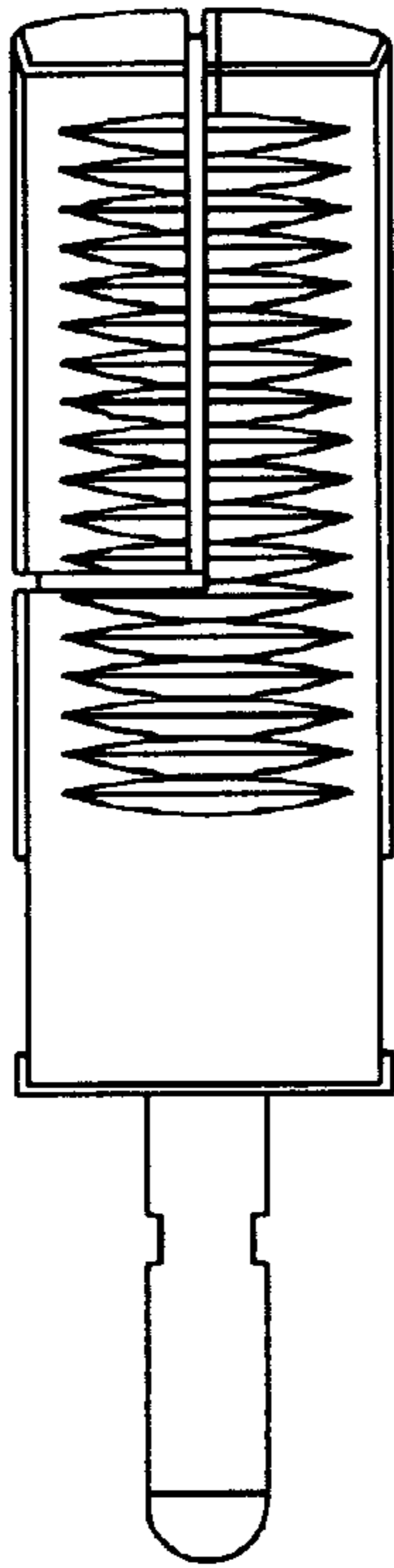

FIG. 6

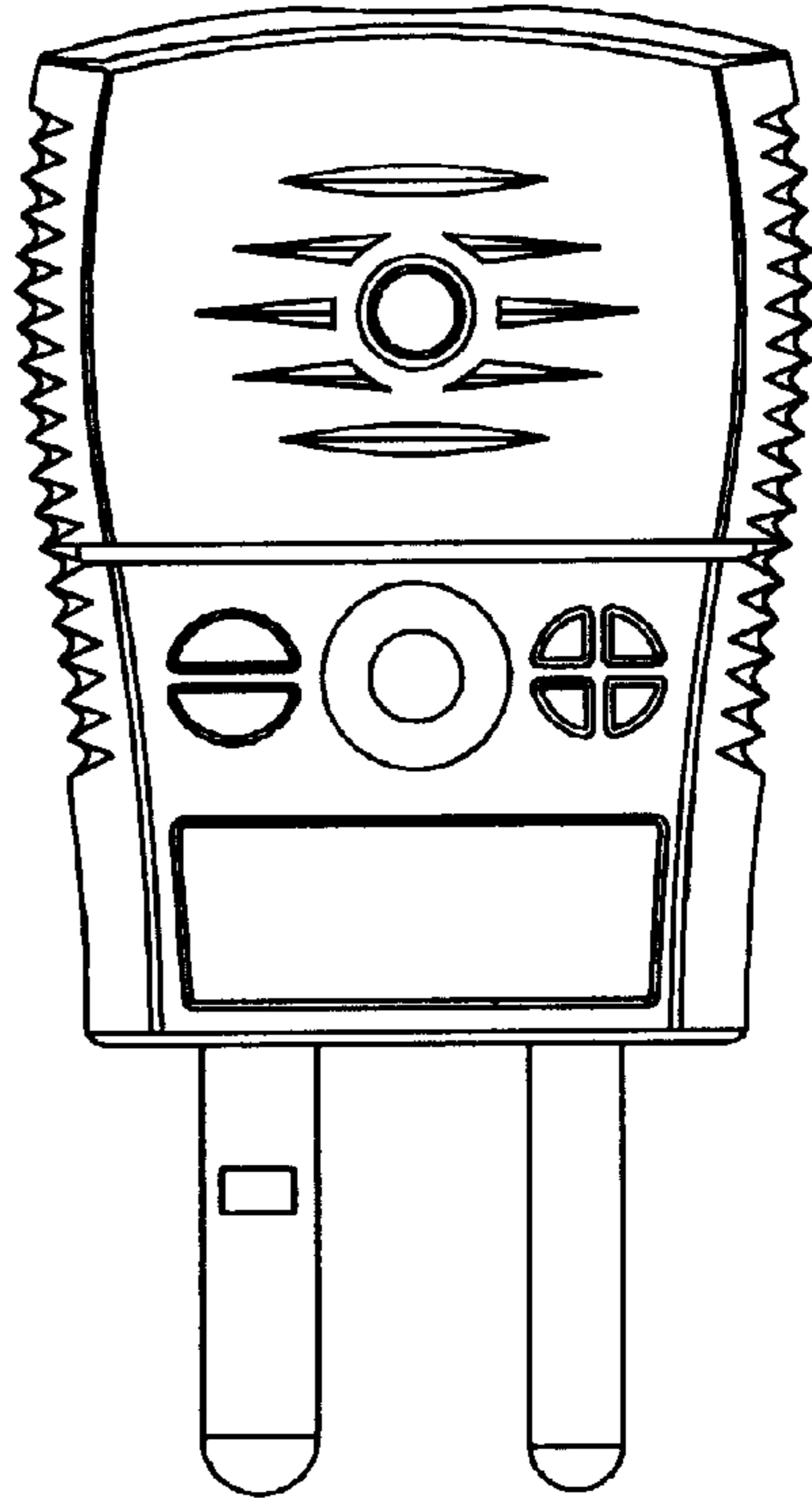

FIG. 7

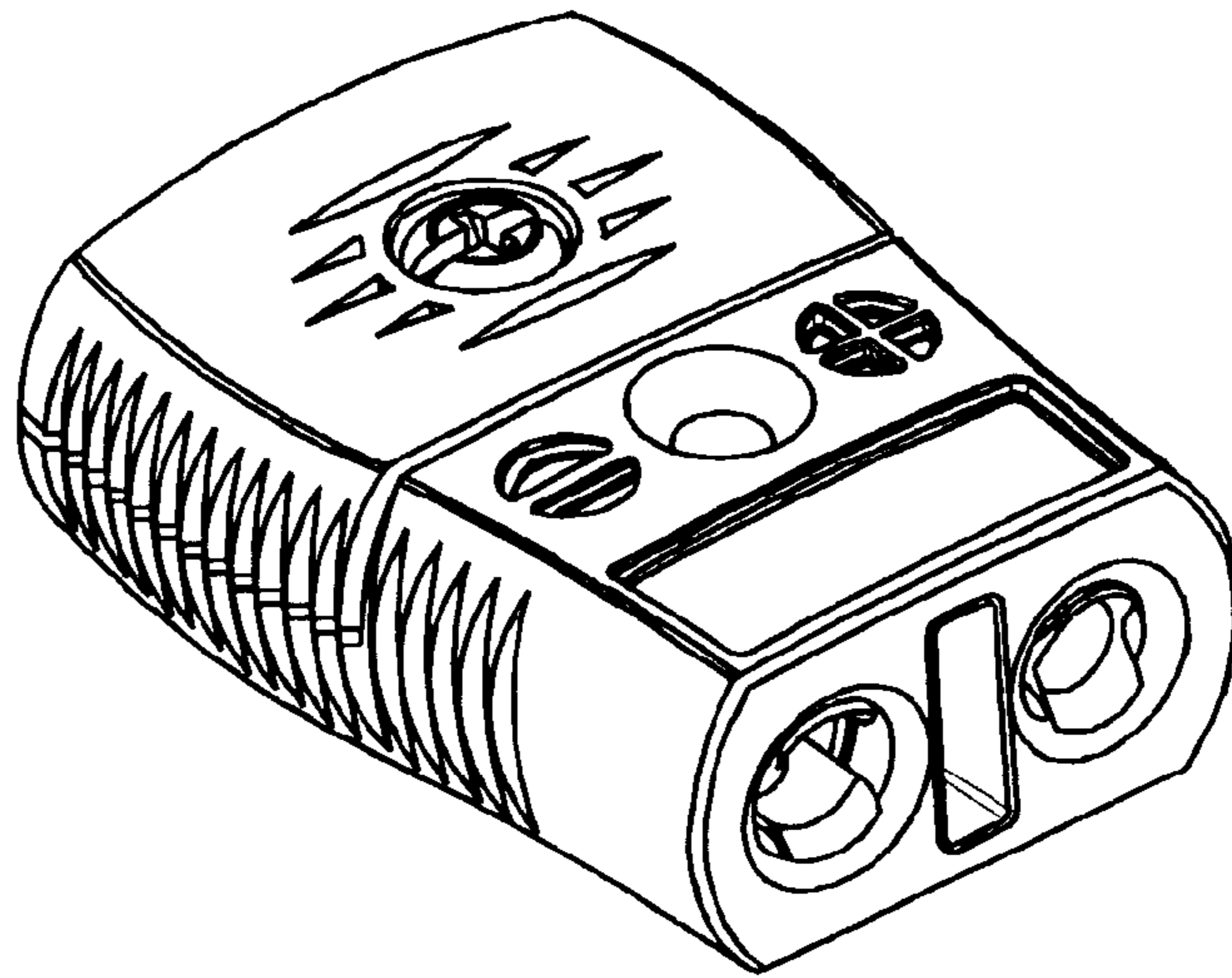

FIG. 8

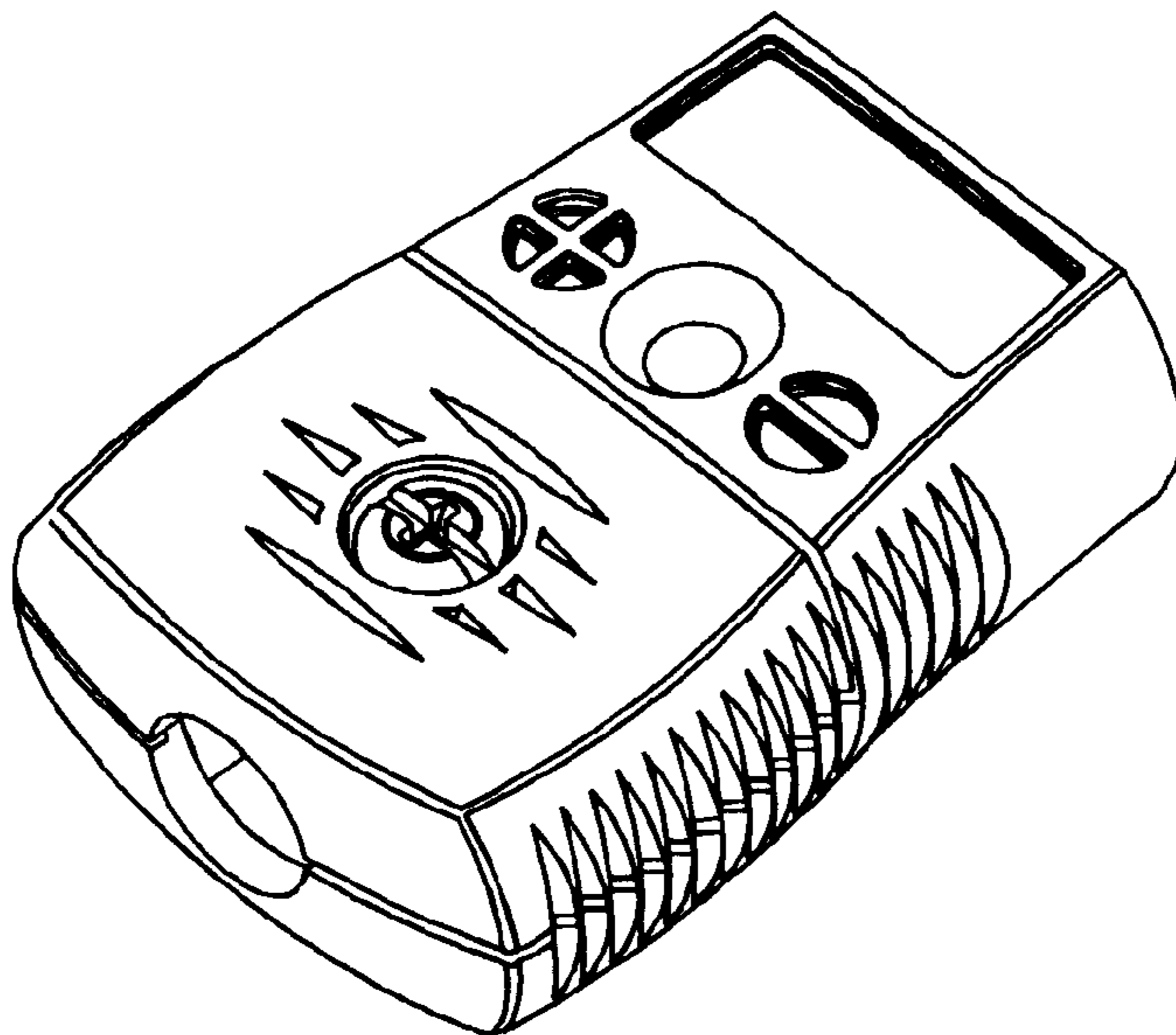

FIG. 9

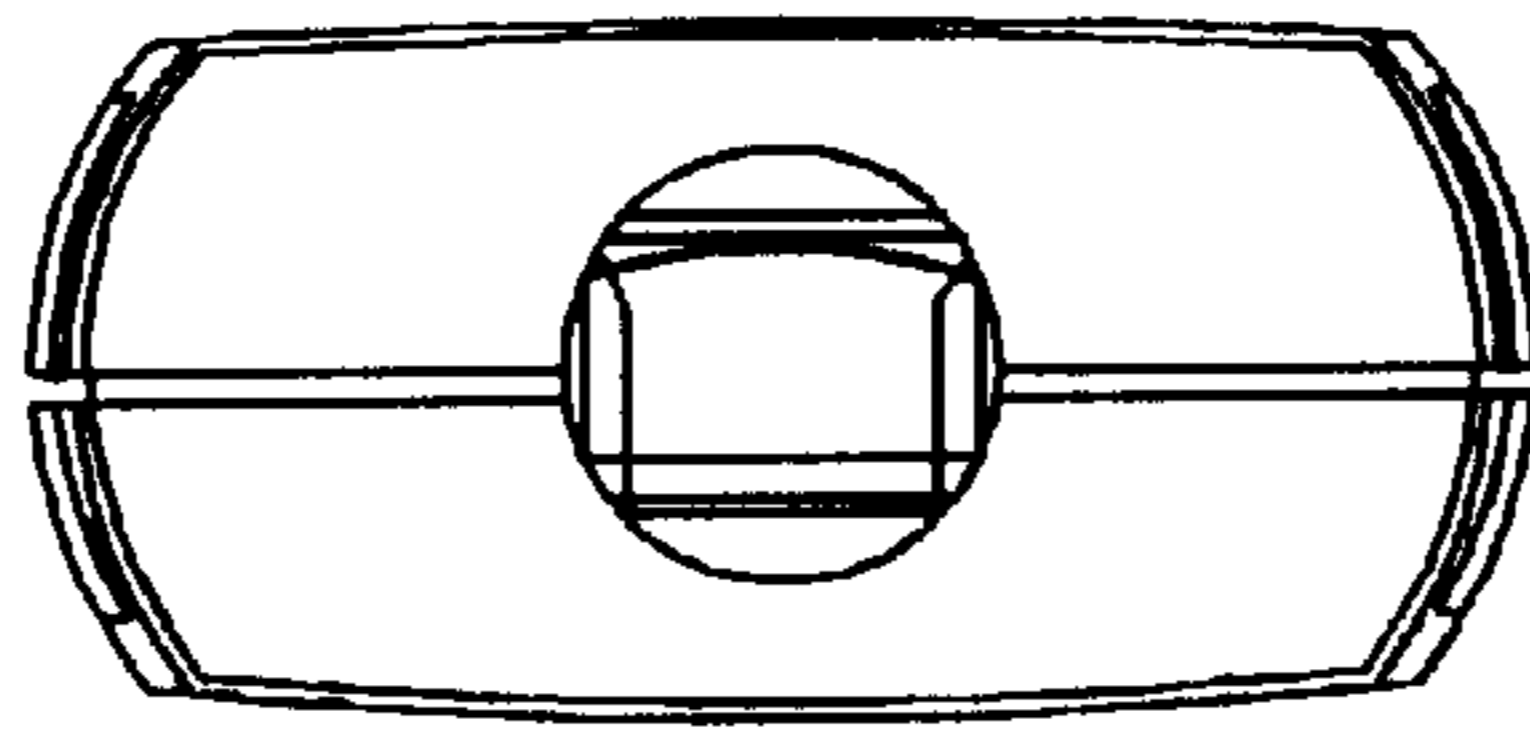

FIG. 11

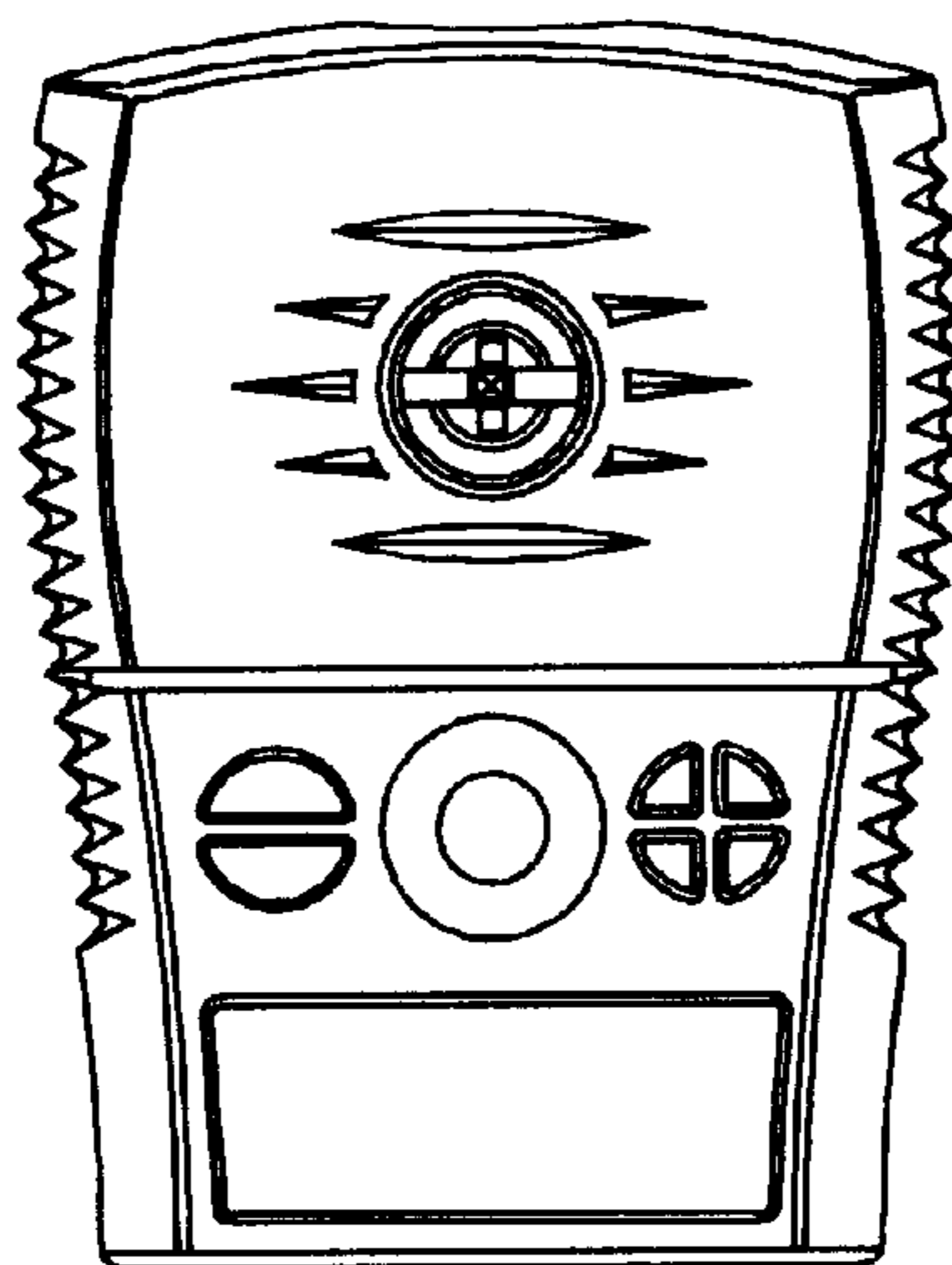

FIG. 10

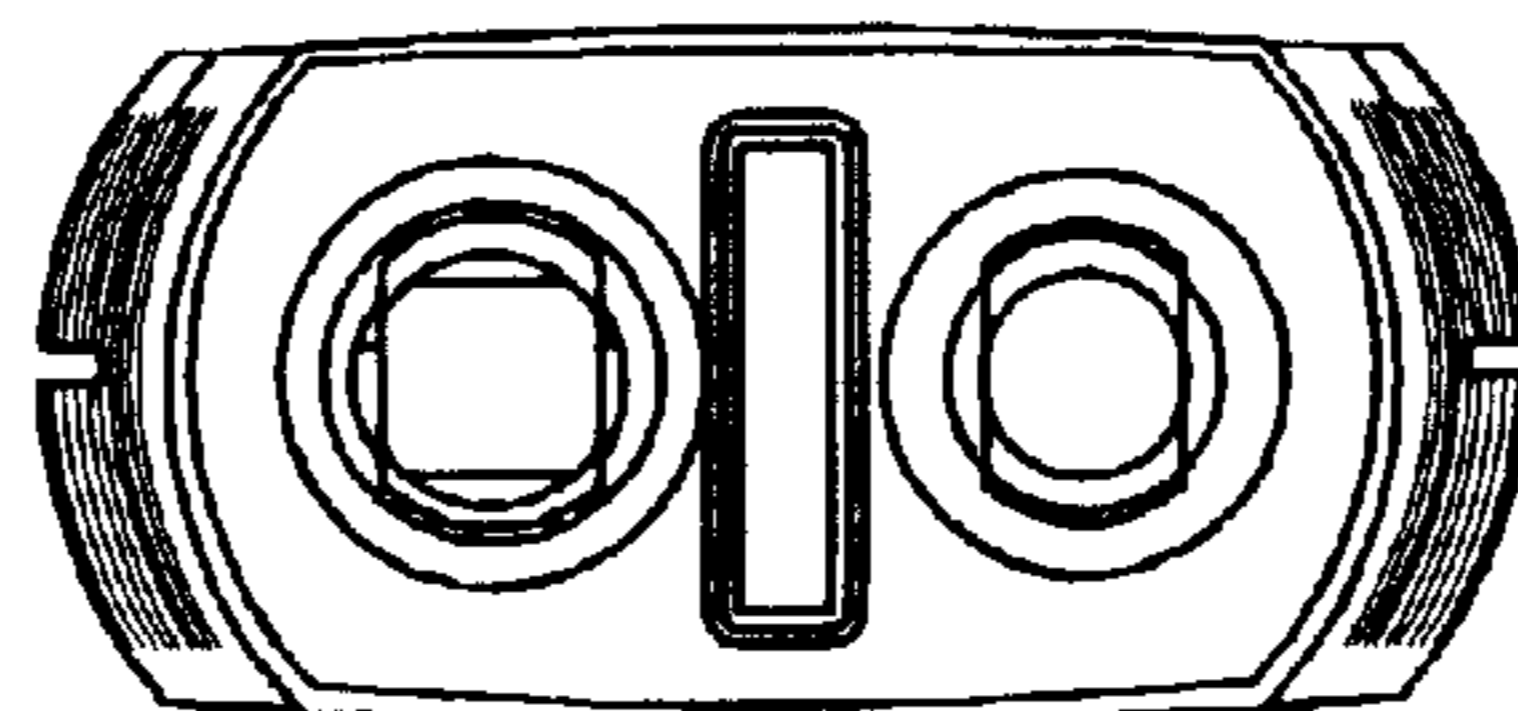

FIG. 12

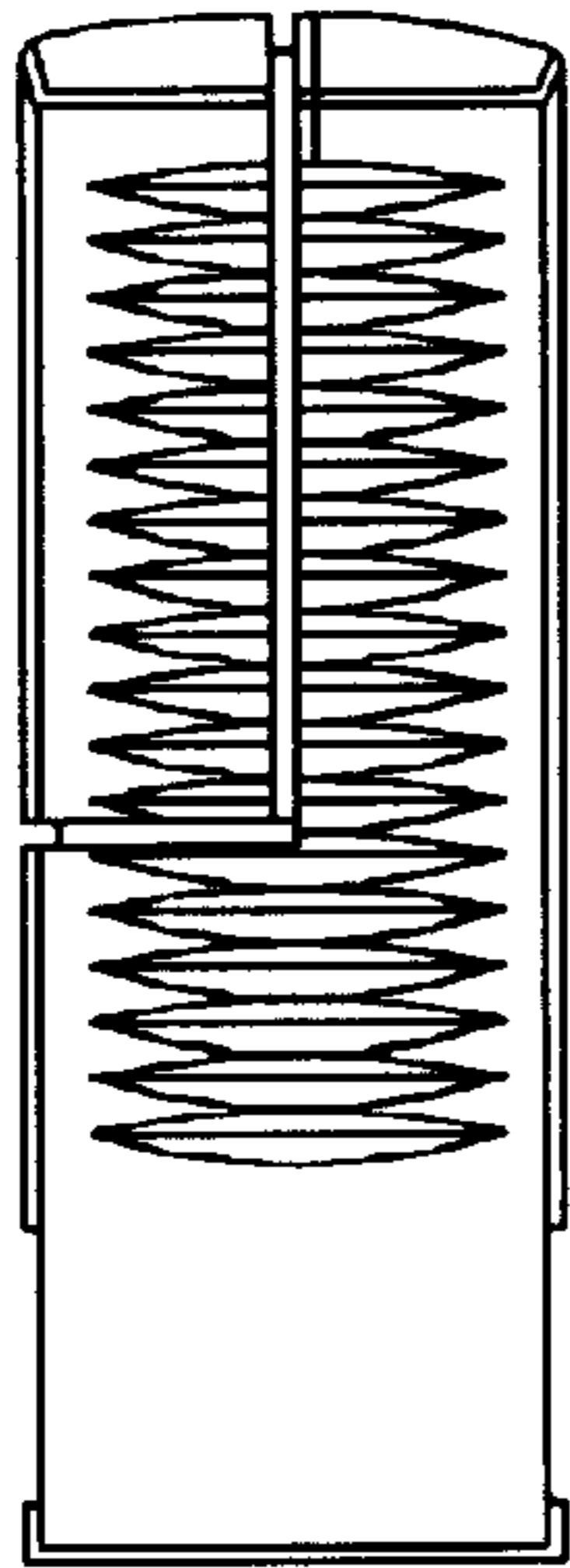

FIG. 13

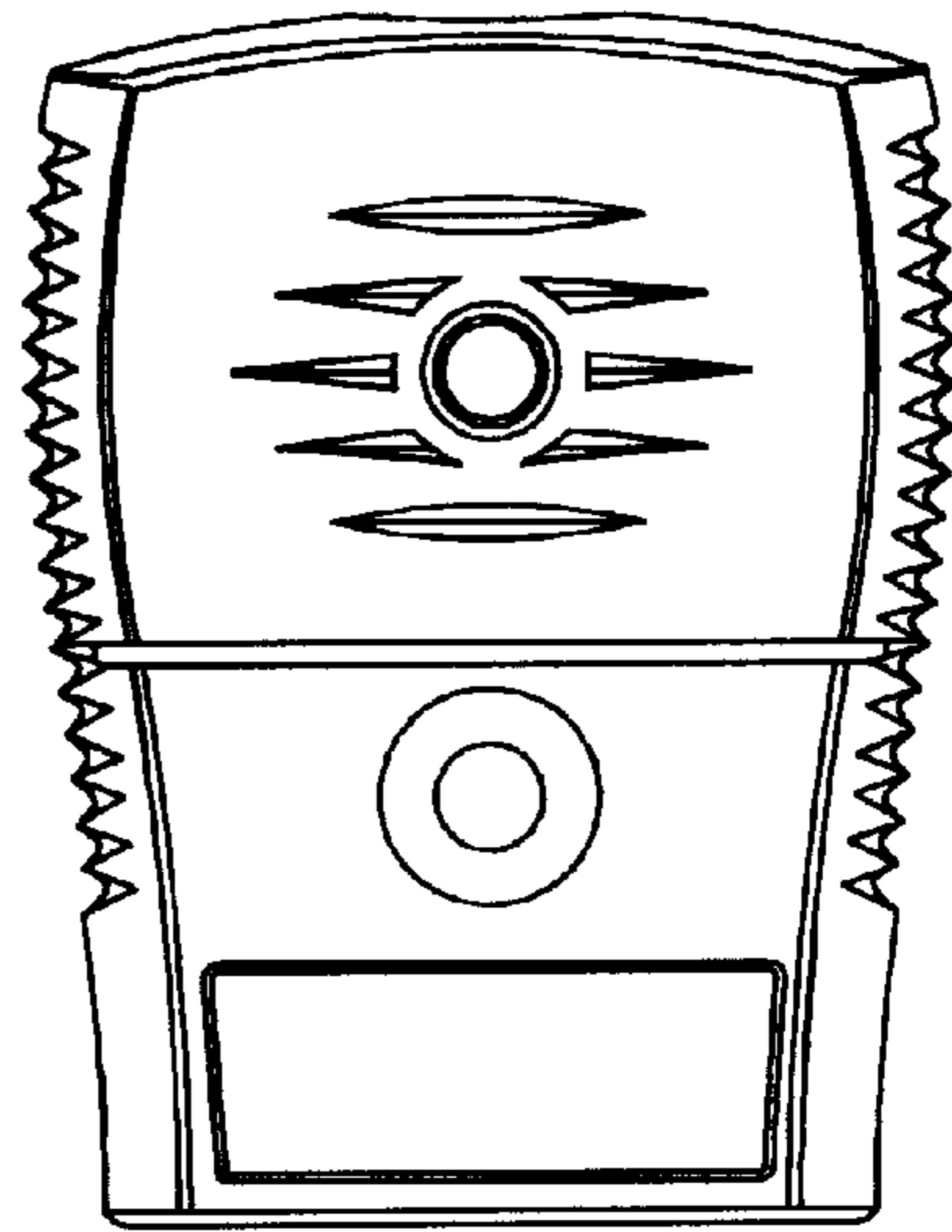

FIG. 14

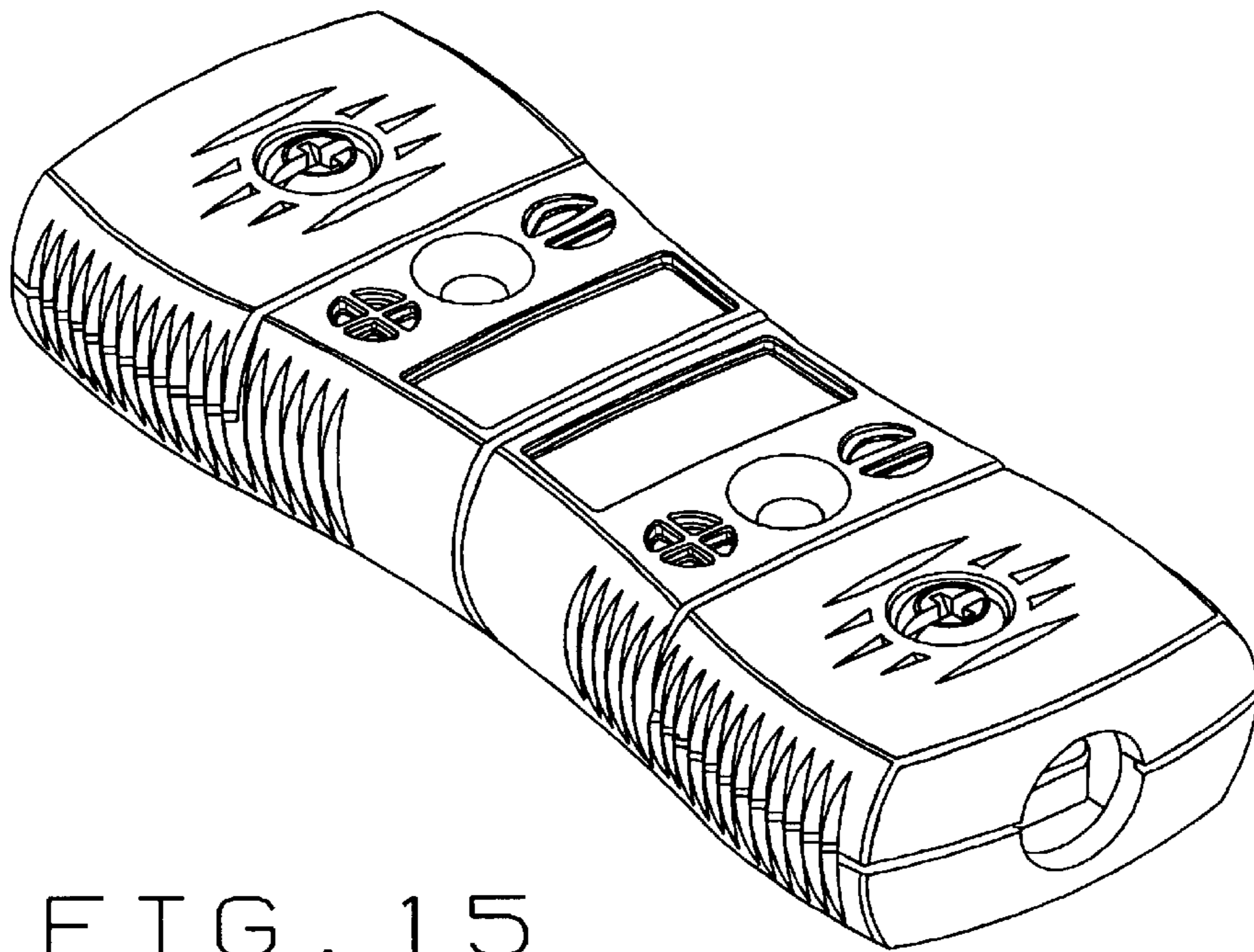

FIG. 15

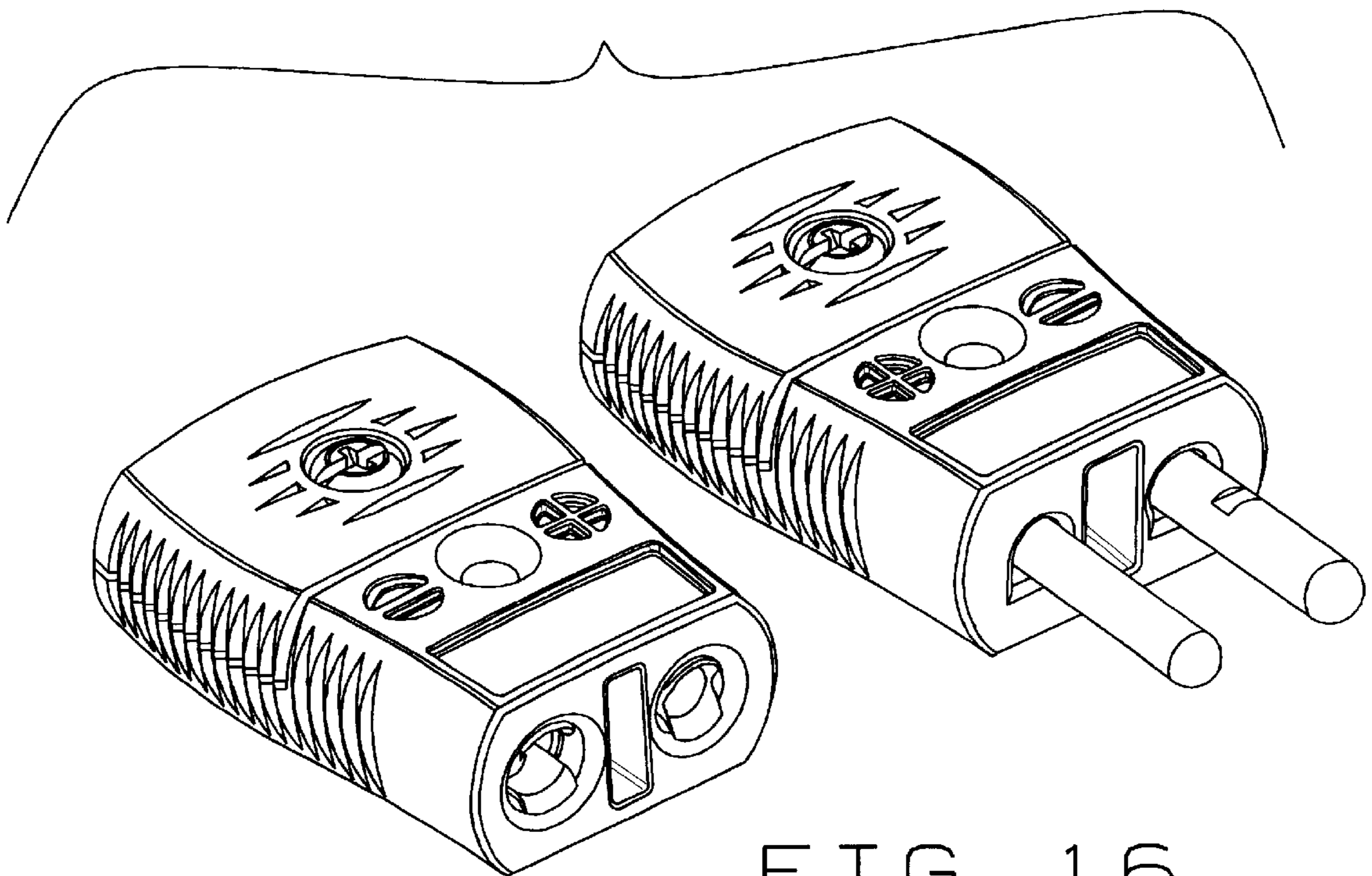

FIG. 16