



US00D423964S

# United States Patent [19] Gander et al.

[11] **Patent Number: Des. 423,964**

[45] **Date of Patent: \*\* May 2, 2000**

[54] **HANGING SCALE**

D. 403,976 1/1999 Suzuki et al. .... D10/88

[75] Inventors: **Terry Gander**, Bracknell; **Martin Gaze**, Woking, both of United Kingdom

*Primary Examiner*—Antoine Duval Davis  
*Attorney, Agent, or Firm*—Kirschstein, et al.

[73] Assignee: **GEC Avery Limited**, United Kingdom

[\*\*] Term: **14 Years**

### [57] CLAIM

The ornamental design for hanging scale, as shown.

[21] Appl. No.: **29/102,054**

### DESCRIPTION

[22] Filed: **Mar. 16, 1999**

### [30] Foreign Application Priority Data

Sep. 17, 1998 [GB] United Kingdom ..... 2077675

FIG. 1 is a front elevational view of a hanging scale in accordance with the design of our invention;

[51] **LOC (7) Cl.** ..... **10-04**

FIG. 2 is a top plan view thereof;

[52] **U.S. Cl.** ..... **D10/88; D10/89**

FIG. 3 is a rear elevational view thereof;

[58] **Field of Search** ..... D10/88, 89; 177/210 R, 177/210 C, 210 EM, 210 FP, 212-214, 225, 229-232, 235, 238-243, 245, DIG. 3

FIG. 4 is a left side elevational view thereof;

FIG. 5 is a right side elevational view thereof;

FIG. 6 is a bottom plan view thereof; and,

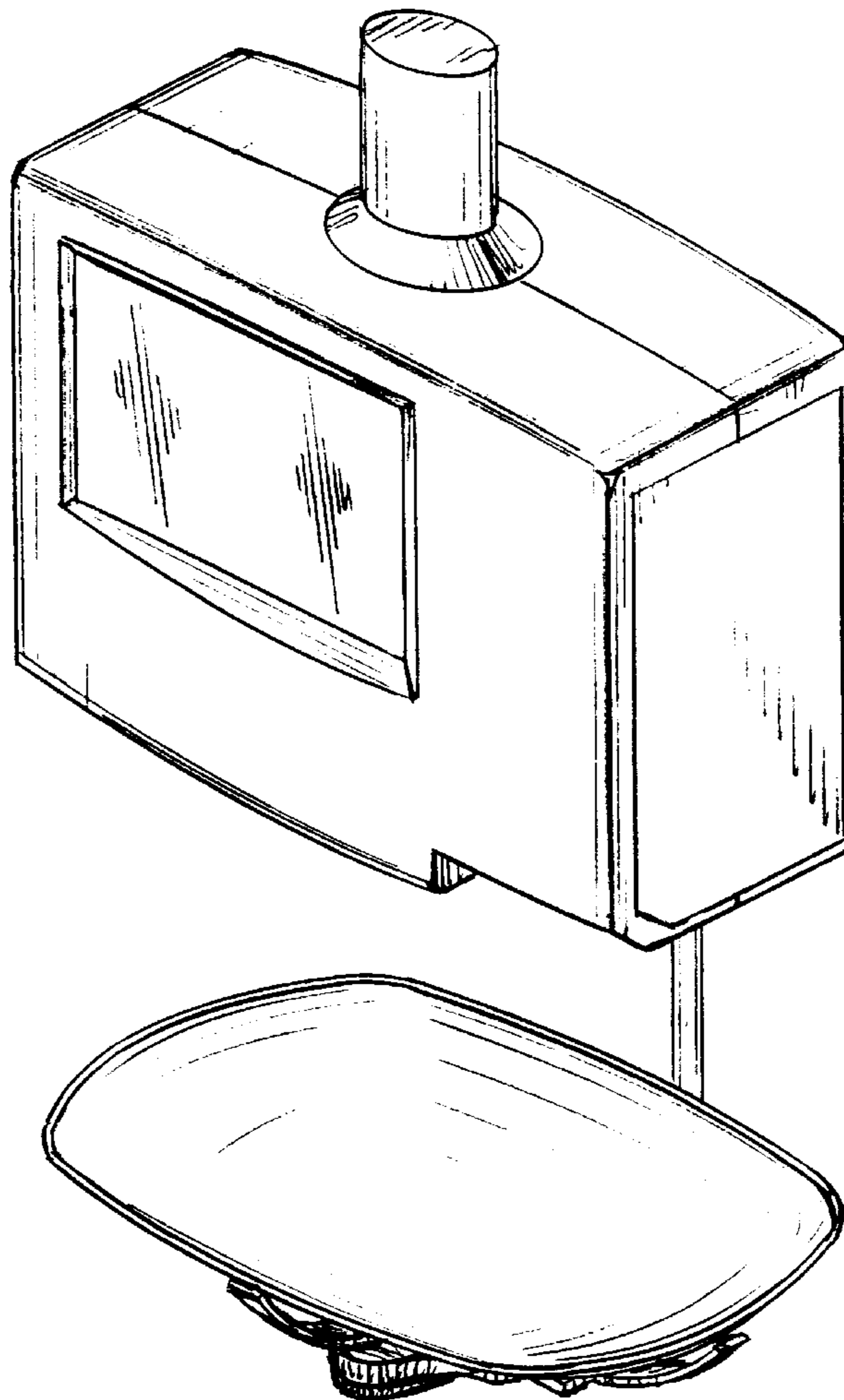
FIG. 7 is a front, top and right side, perspective view thereof.

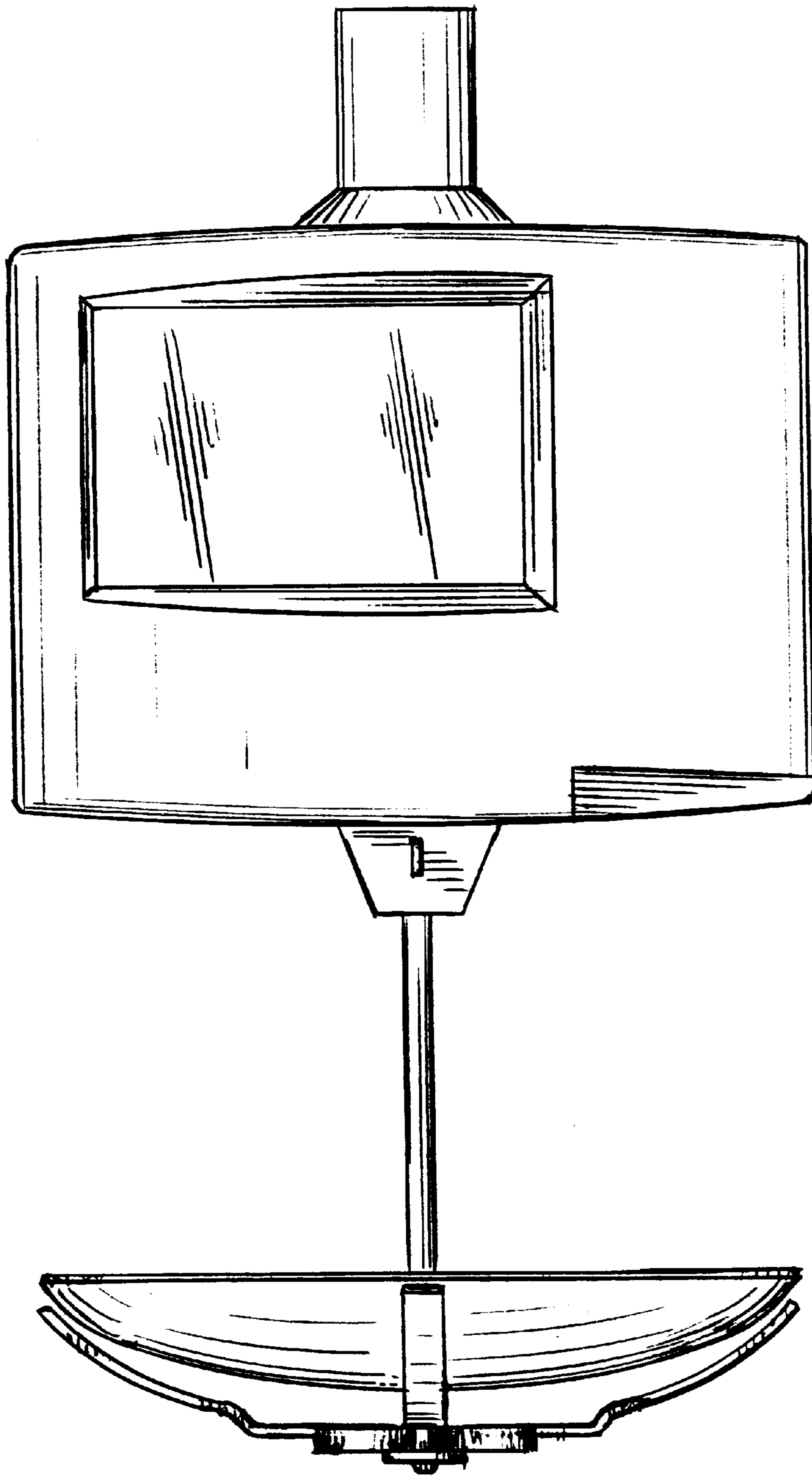
### [56] References Cited

#### U.S. PATENT DOCUMENTS

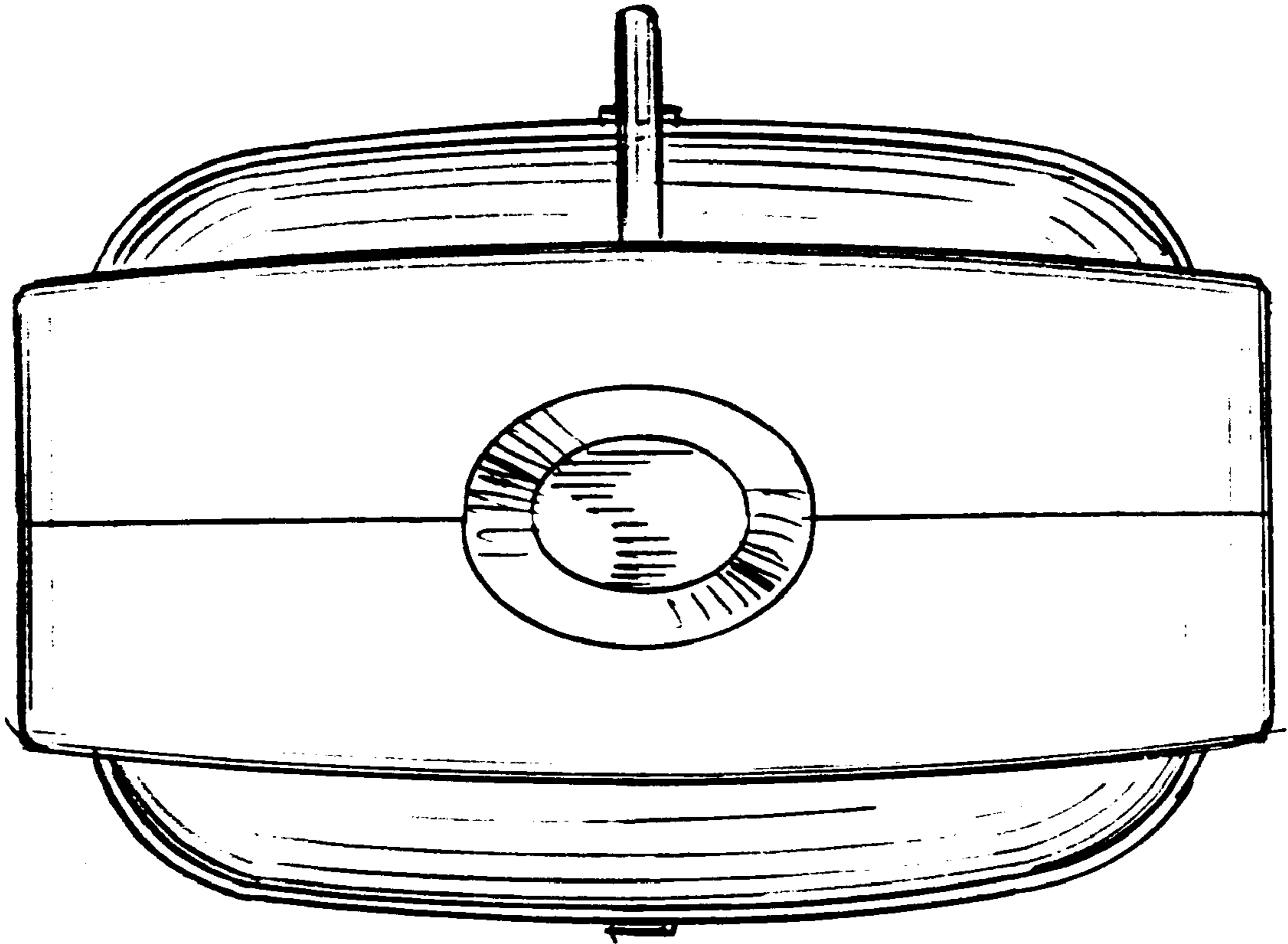
D. 367,823 3/1996 Sassoli ..... D10/90

**1 Claim, 7 Drawing Sheets**

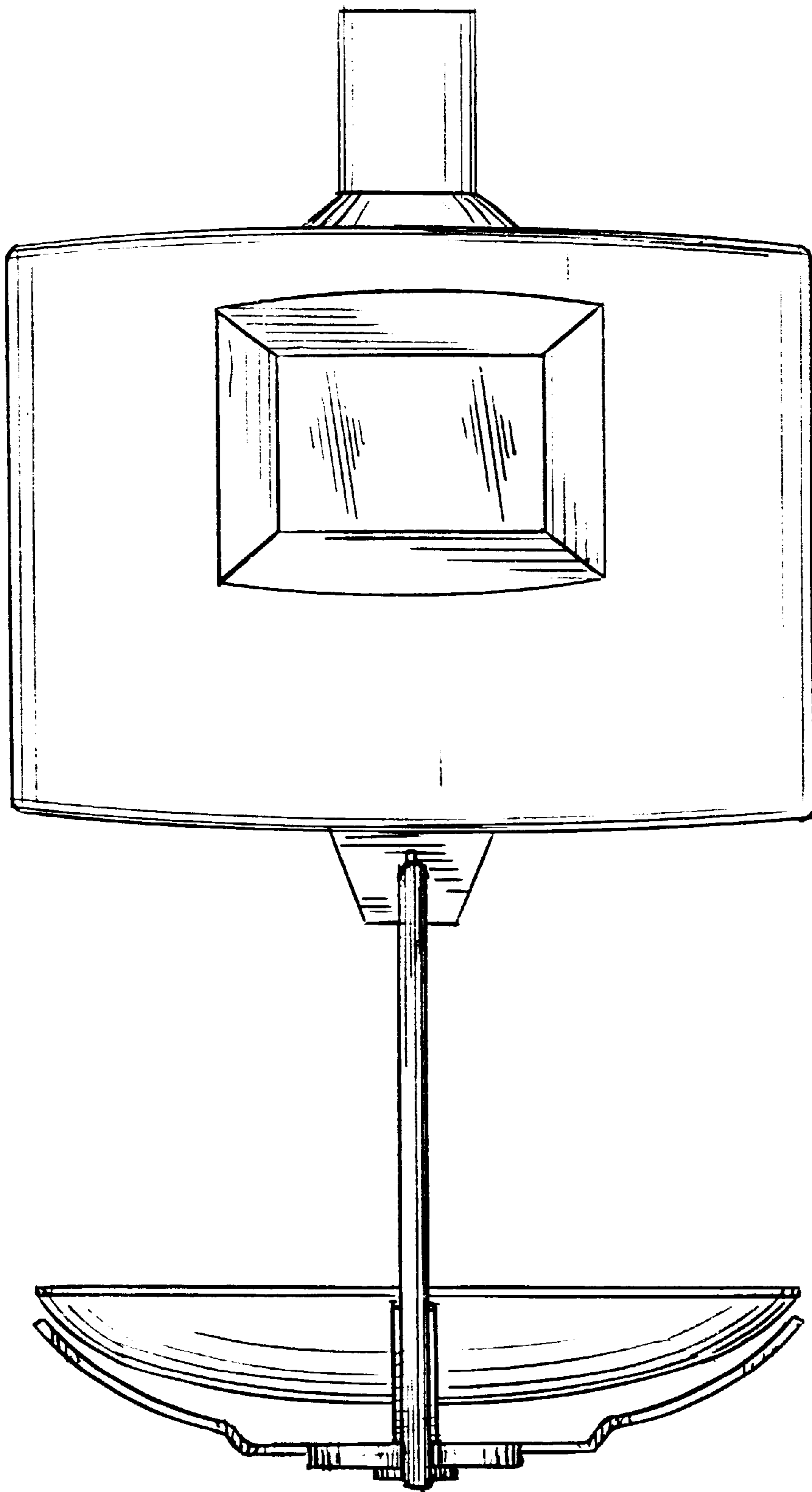




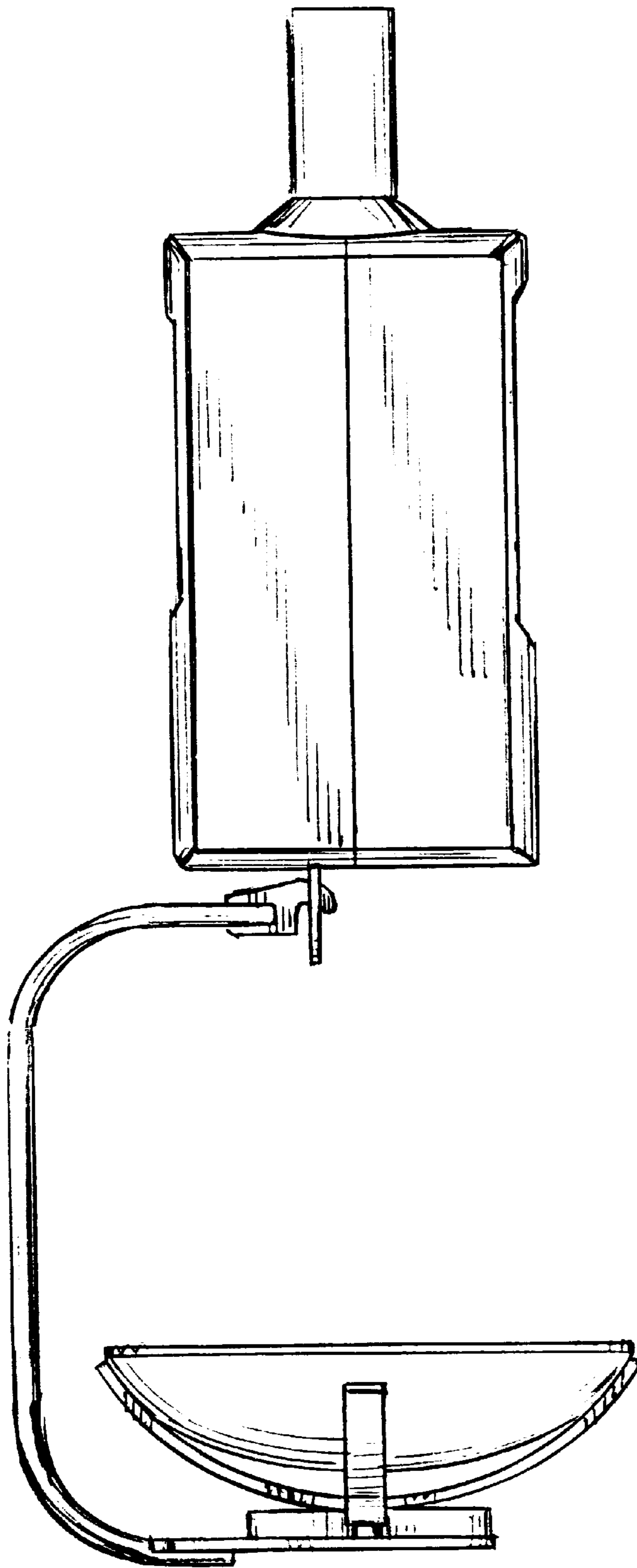
**FIG. 1**



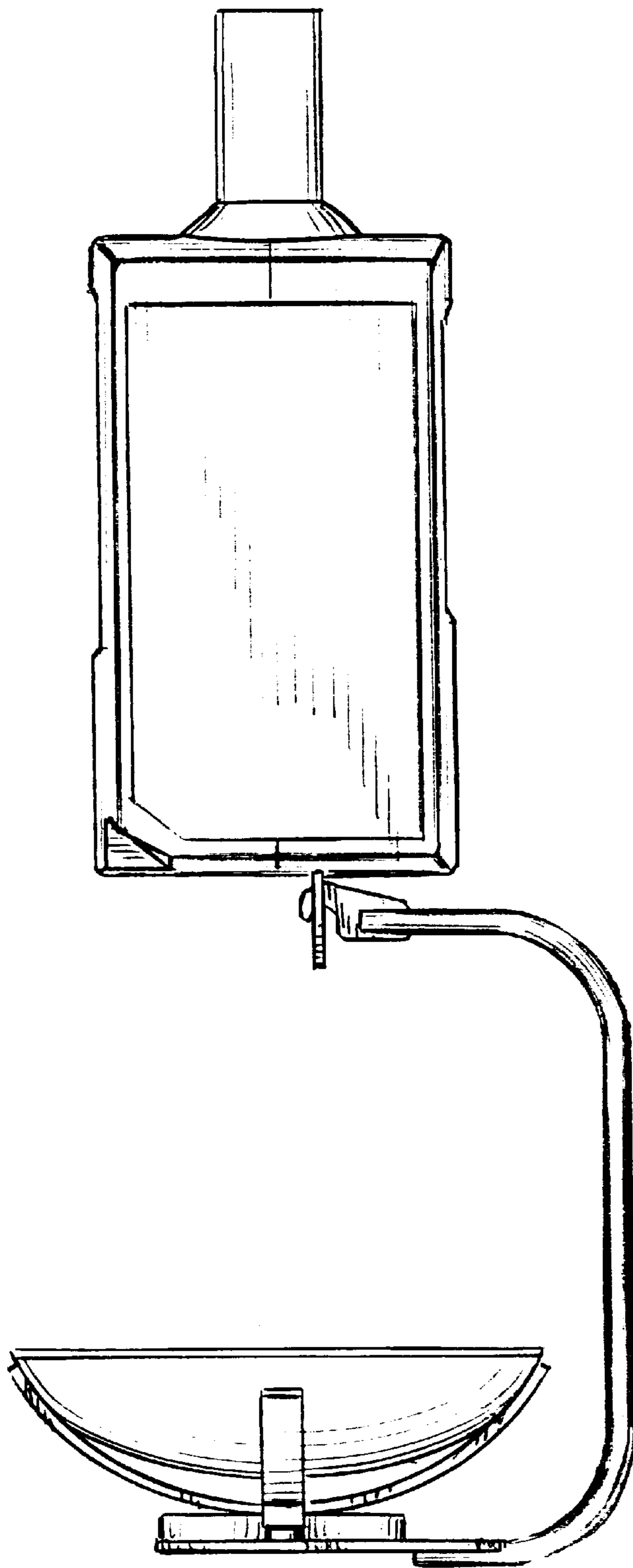
**FIG. 2**



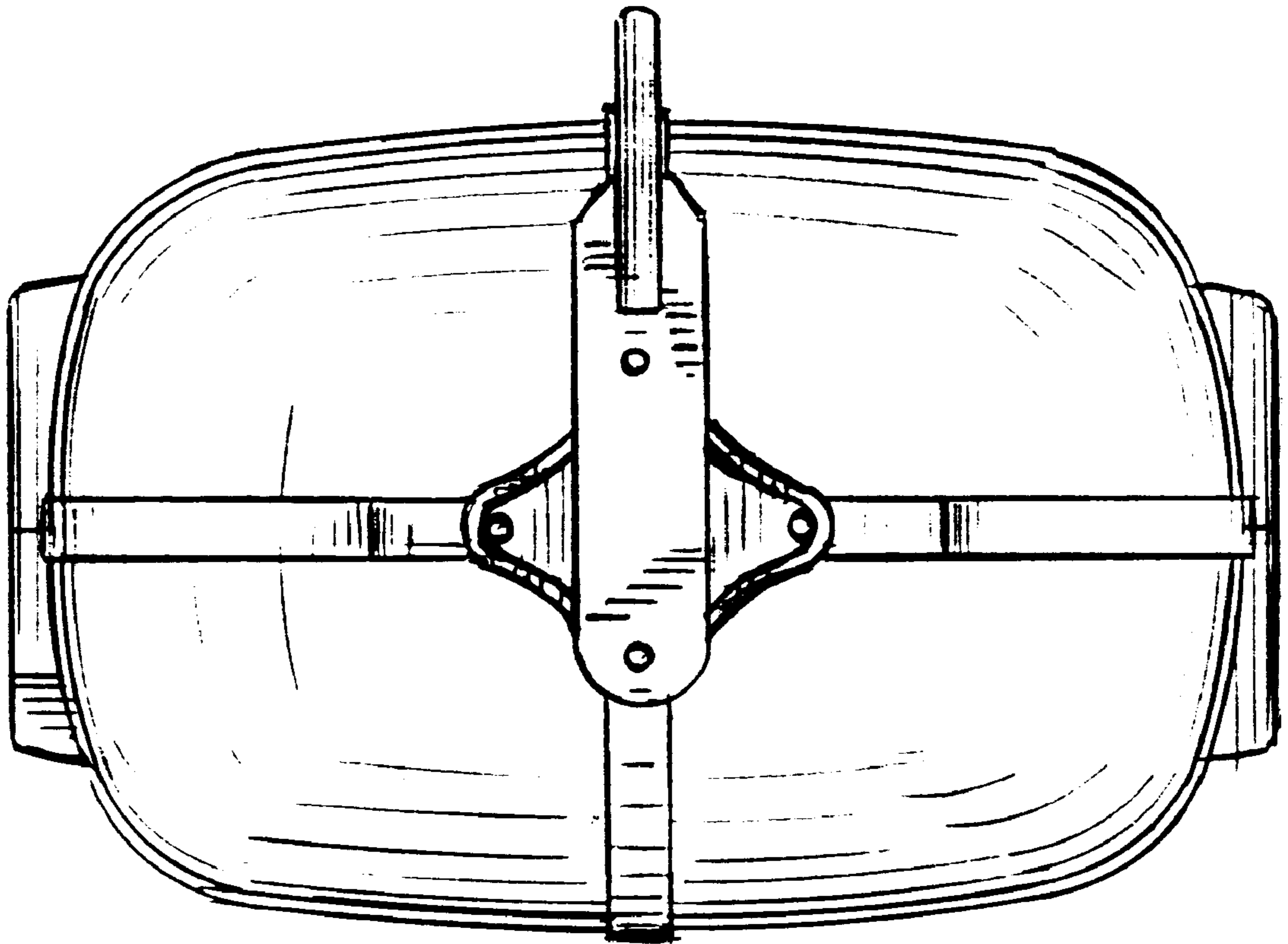
*FIG. 3*



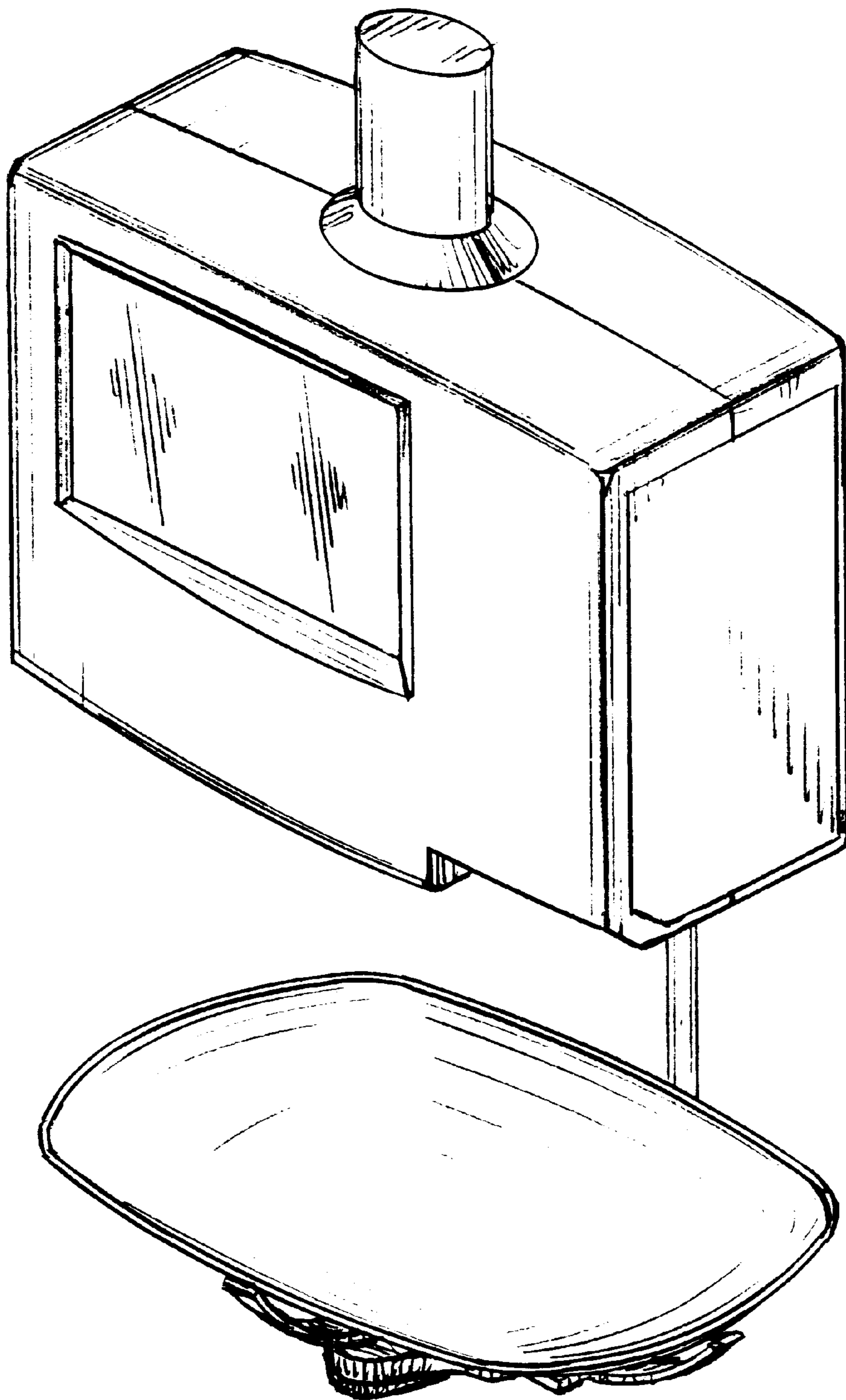
*FIG. 4*



**FIG. 5**



**FIG. 6**



**FIG. 7**