



US00D423946S

# United States Patent [19]

[11] **Patent Number: Des. 423,946**

**Jannard et al.**

[45] **Date of Patent: \*\* May 2, 2000**

[54] **ORNAMENTAL TIMEPIECE**

*Attorney, Agent, or Firm—Knobbe, Martens, Olson & Bear, LLP*

[75] Inventors: **James H. Jannard**, Eastsound, Wash.;  
**Peter Yee**, Irvine, Calif.

[57] **CLAIM**

[73] Assignee: **Oakley, Inc.**, Foothill Ranch, Calif.

The ornamental design for an ornamental timepiece, as shown and described.

[\*\*] Term: **14 Years**

**DESCRIPTION**

[21] Appl. No.: **29/094,053**

FIG. 1 is a front perspective view of the ornamental timepiece of the present invention;

[22] Filed: **Sep. 24, 1998**

FIG. 2 is a top plan view thereof;

[51] **LOC (7) Cl.** ..... **10-02**

FIG. 3 is a bottom plan view thereof;

[52] **U.S. Cl.** ..... **D10/30; D10/128**

FIG. 4 is a right-side elevational view thereof;

[58] **Field of Search** ..... **D10/1-40, 122-132;**

**368/280-282, 276-277, 285**

FIG. 5 is a left-side elevational view thereof;

[56] **References Cited**

**U.S. PATENT DOCUMENTS**

- D. 282,914 3/1986 Maron .
- D. 297,622 9/1988 Lee ..... D10/38
- D. 303,091 8/1989 Goto .
- D. 323,299 1/1992 Wakamatsu .
- D. 365,526 12/1995 Gardner .
- 4,204,399 5/1980 Heynisch .
- 4,747,086 5/1988 Shaw .
- 4,920,524 4/1990 Kotob .
- 5,297,121 3/1994 Sepehri .
- 5,574,701 11/1996 Harilela .

FIG. 6 is a front elevational view thereof;

FIG. 7 is a rear elevational view thereof;

FIG. 8 is a front perspective view of an alternative embodiment of the ornamental timepiece of the present invention;

FIG. 9 is a top plan view of the ornamental design piece of FIG. 8;

FIG. 10 is a bottom plan view of the ornamental timepiece of FIG. 8;

FIG. 11 is a right-side elevational view of the ornamental timepiece of FIG. 8;

FIG. 12 is a left-side elevational view of the ornamental timepiece of FIG. 8;

FIG. 13 is a front elevational view of the ornamental timepiece of FIG. 8; and,

FIG. 14 is a rear elevational view of the ornamental timepiece of FIG. 8.

**FOREIGN PATENT DOCUMENTS**

- 57-175982 10/1982 Japan .

**OTHER PUBLICATIONS**

Hong Kong Enterprise—Dec. 1983—p. 121—Watch at lower left.

*Primary Examiner—Nelson C. Holtje*

**1 Claim, 4 Drawing Sheets**

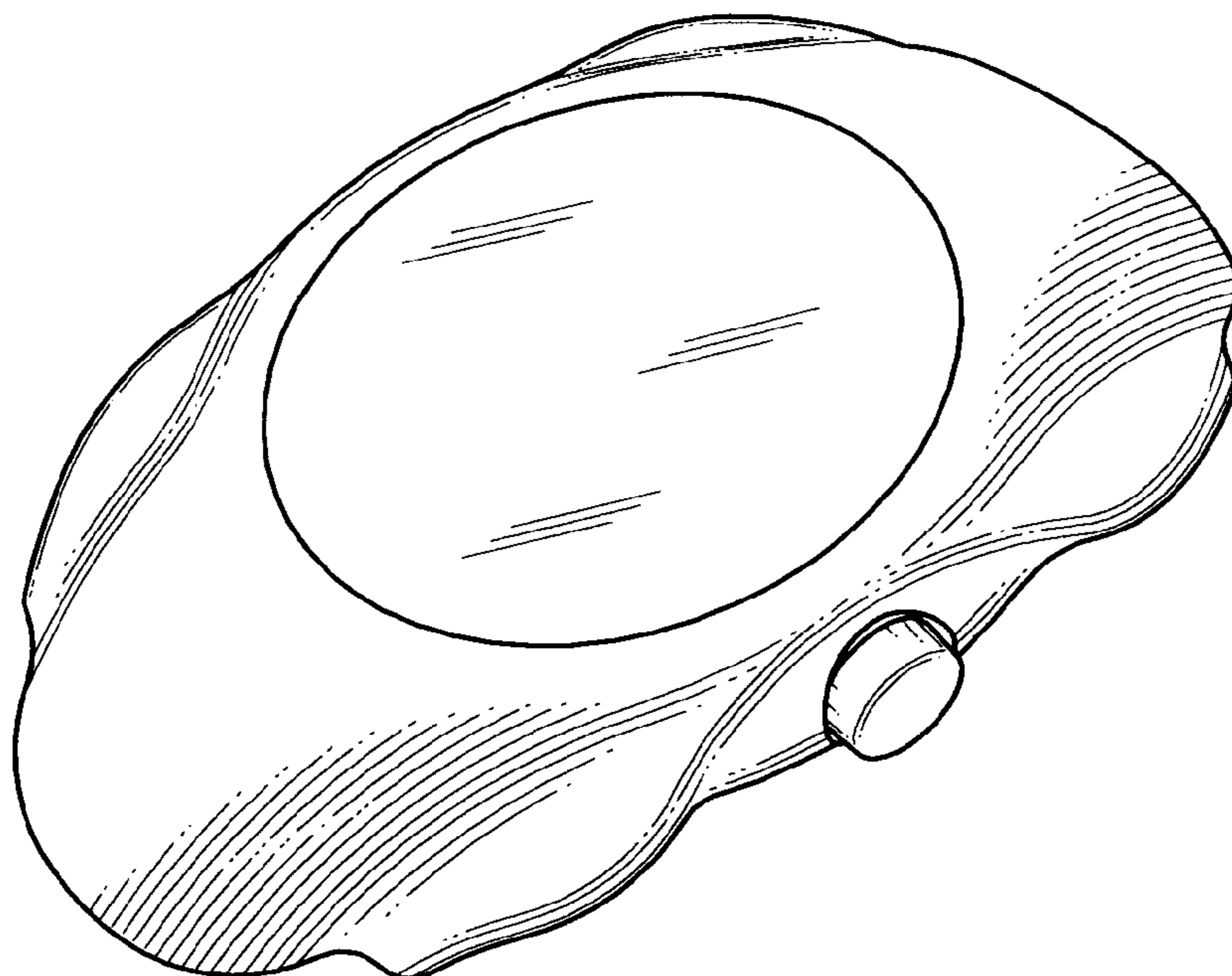

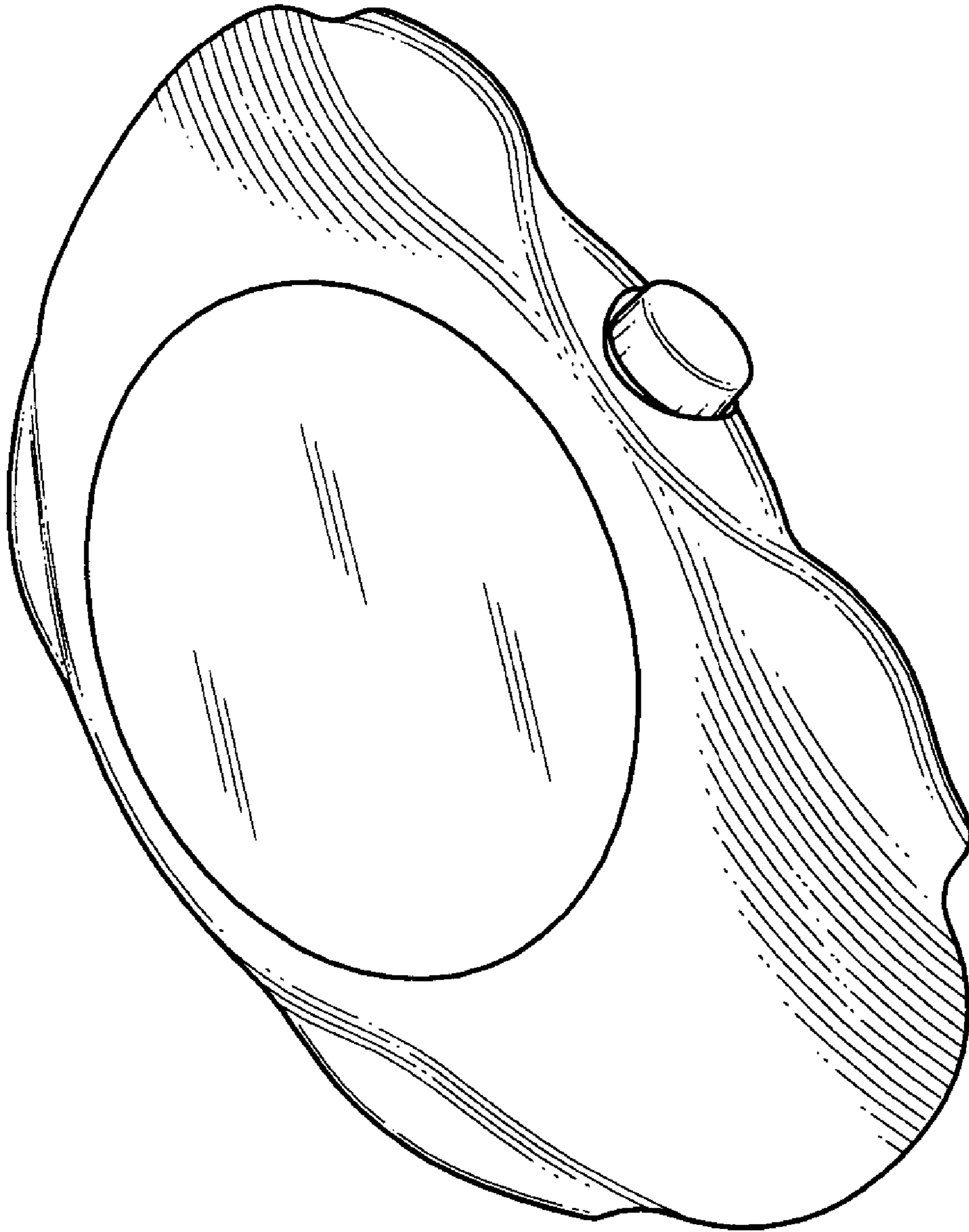

*FIG. 1*

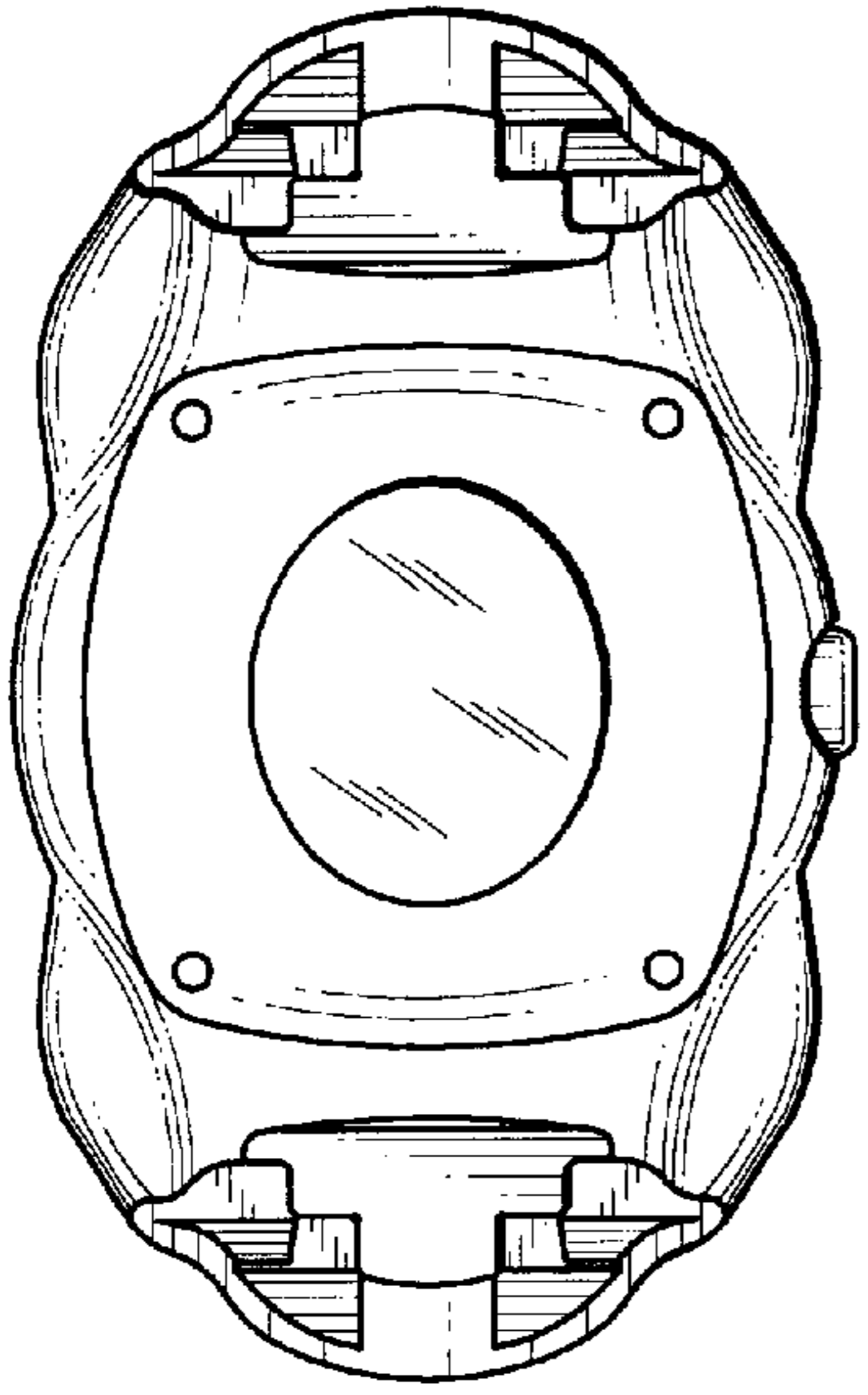

FIG. 3

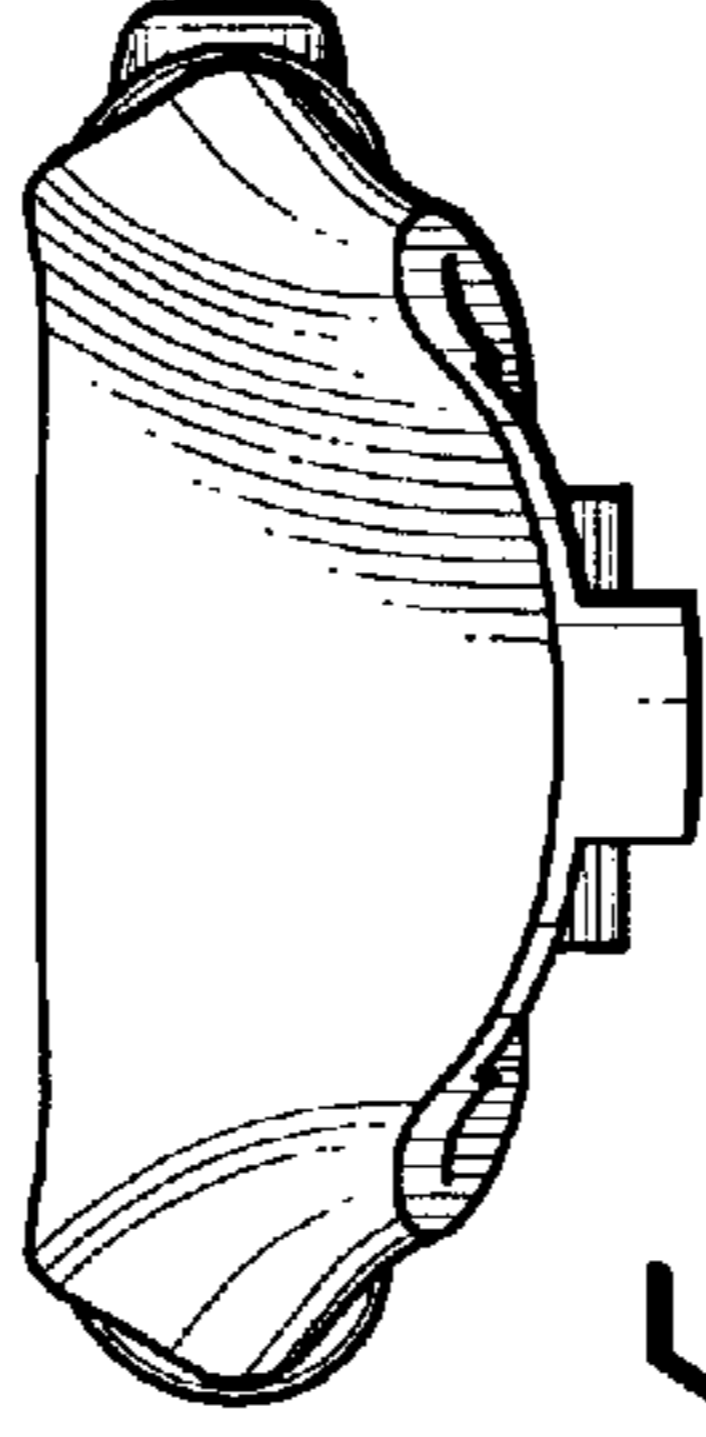

FIG. 5

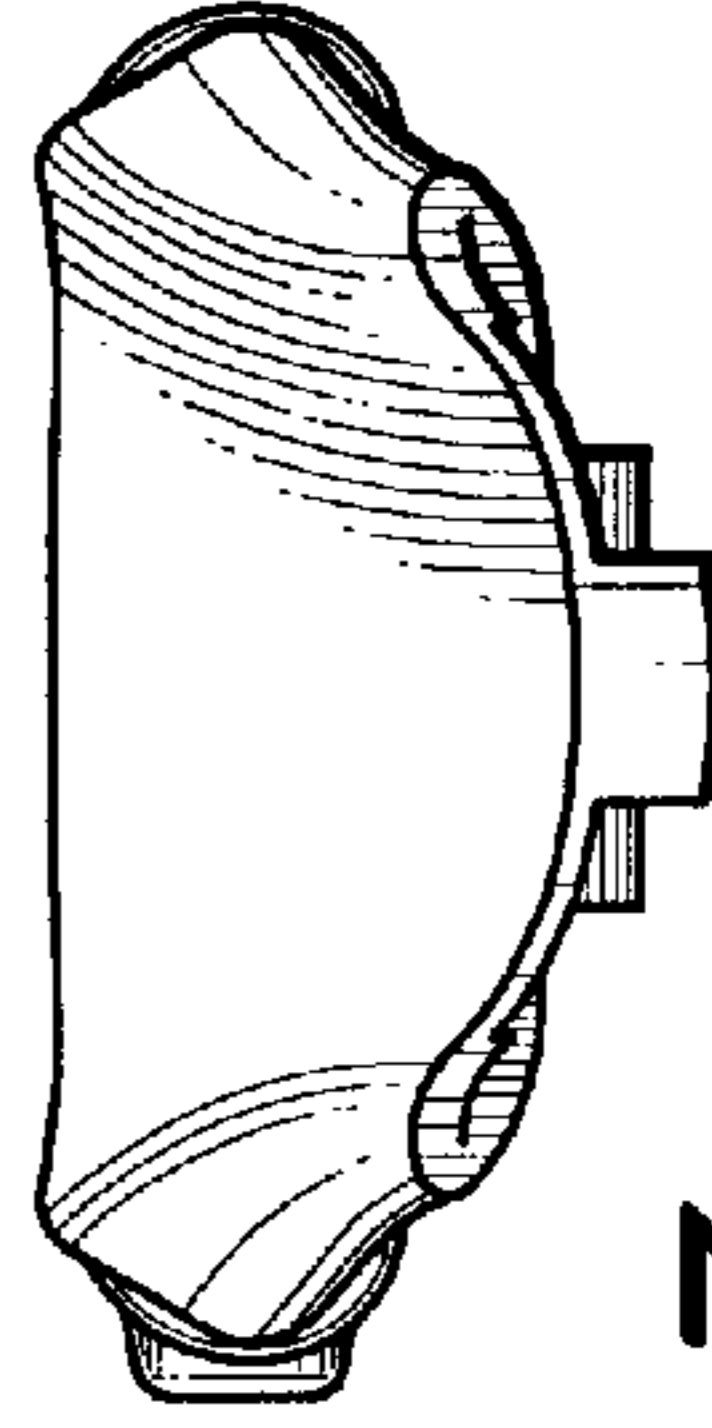

FIG. 7

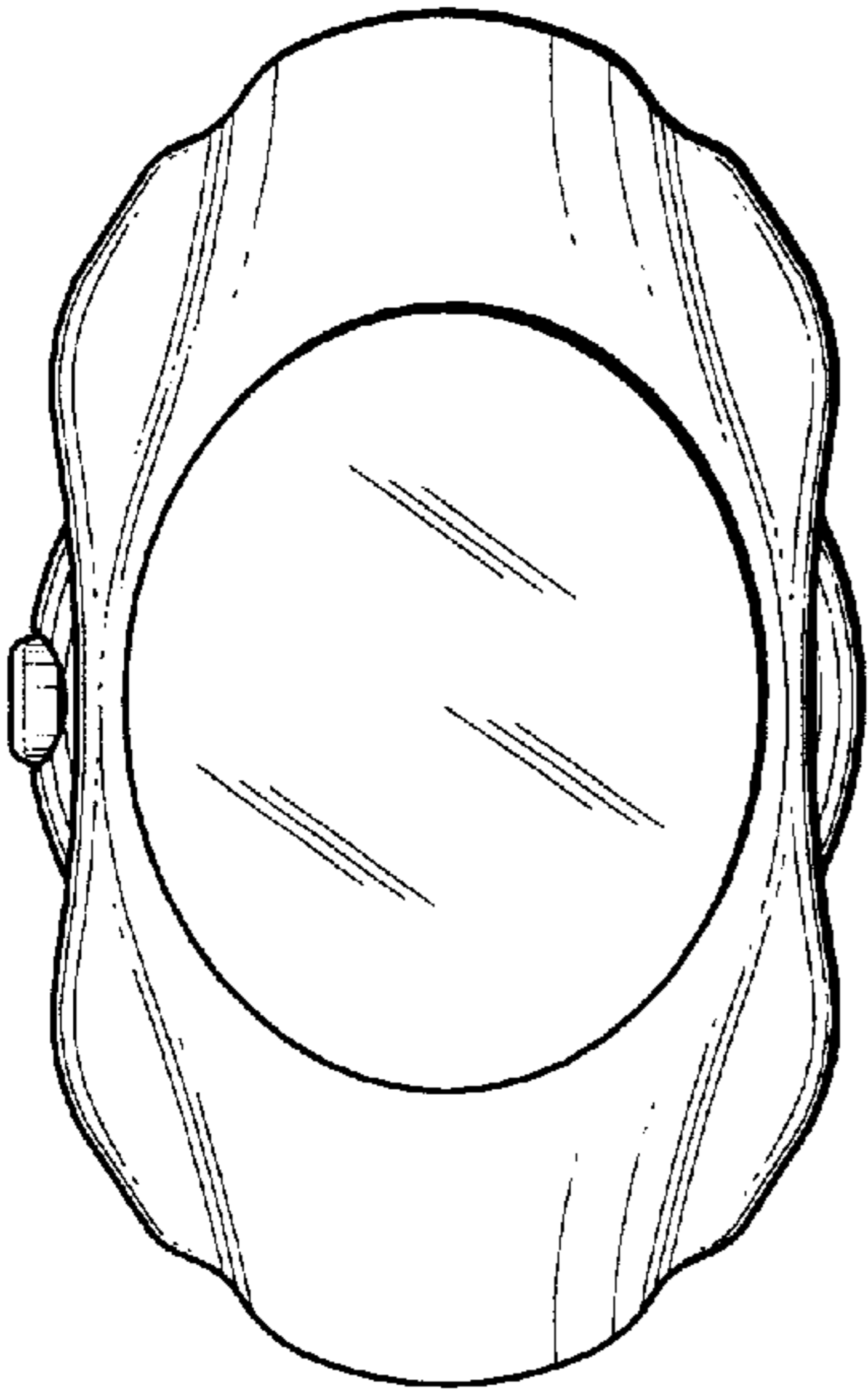

FIG. 2

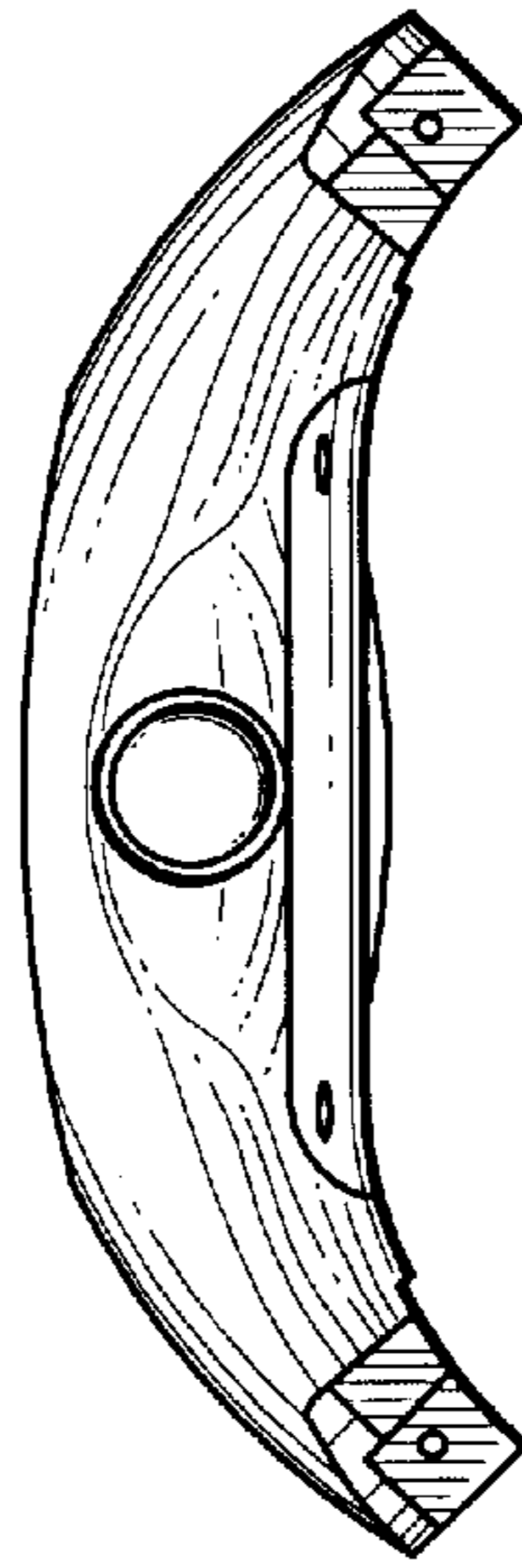

FIG. 4

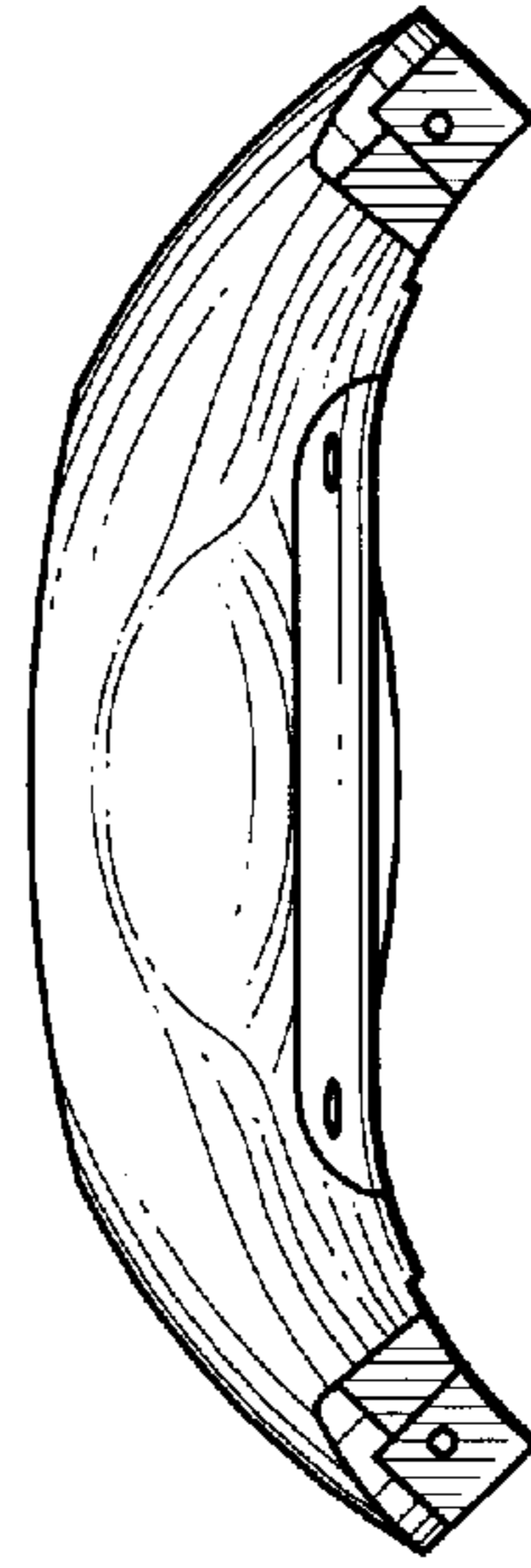
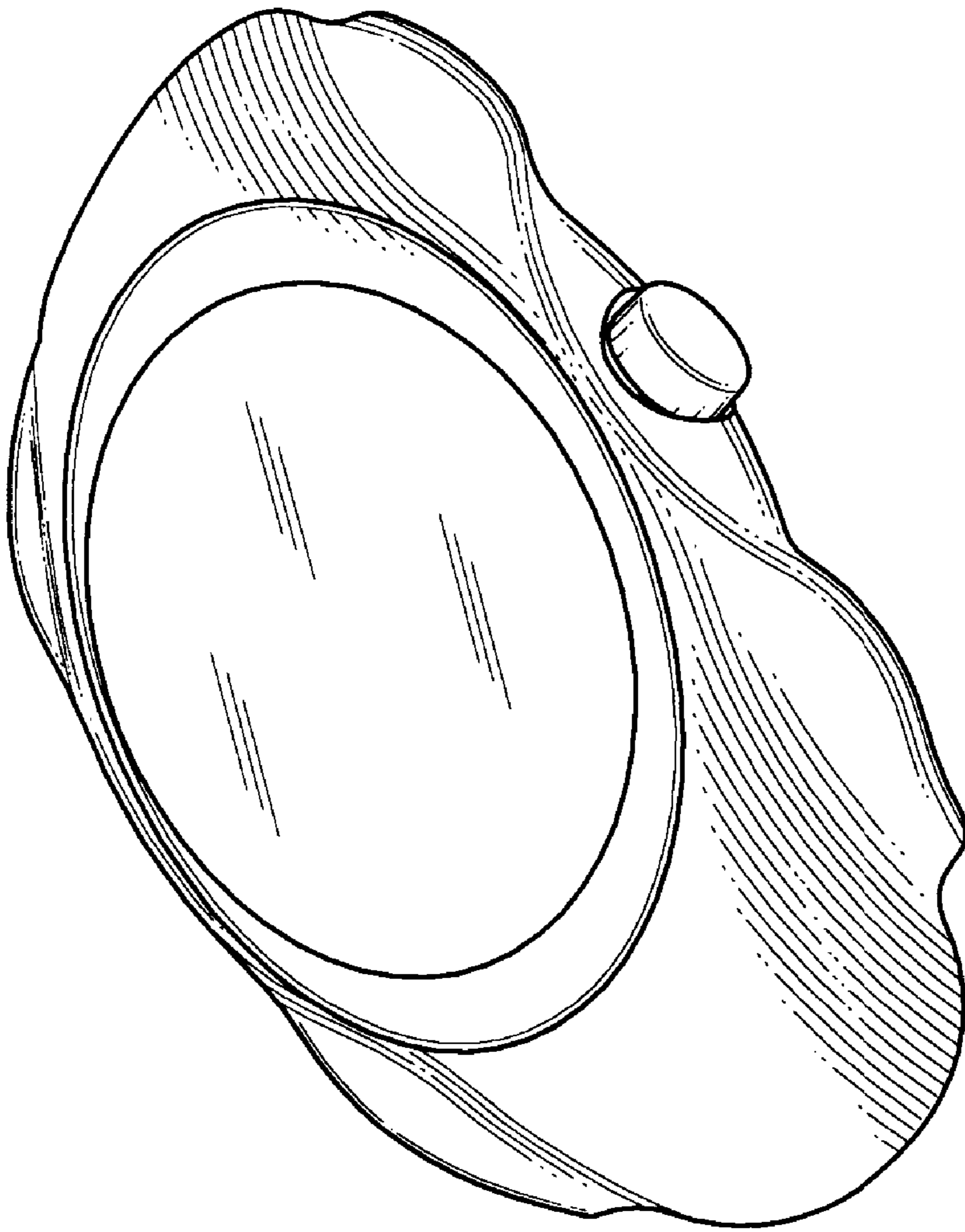
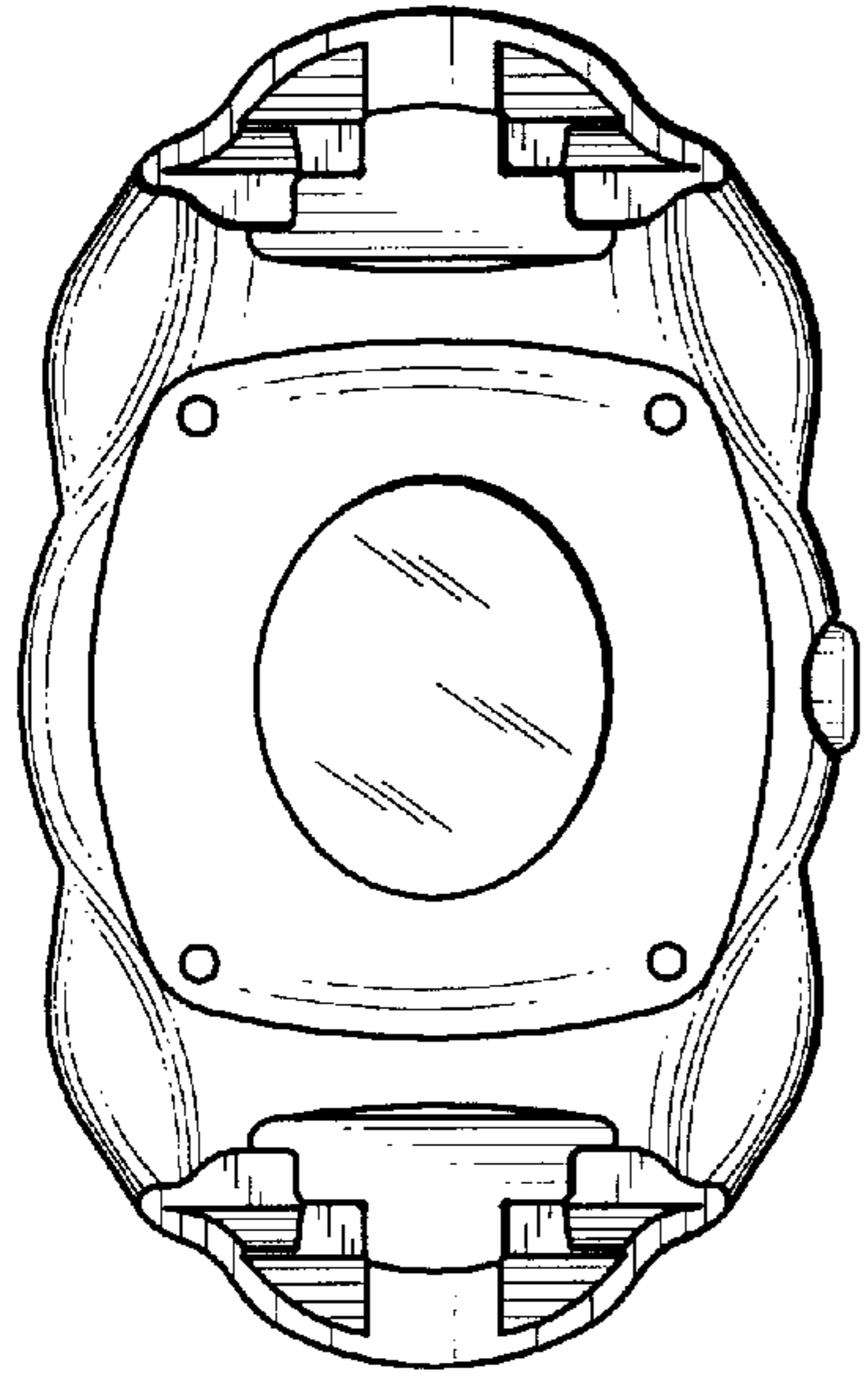

FIG. 6



*FIG. 8*



*FIG. 9*

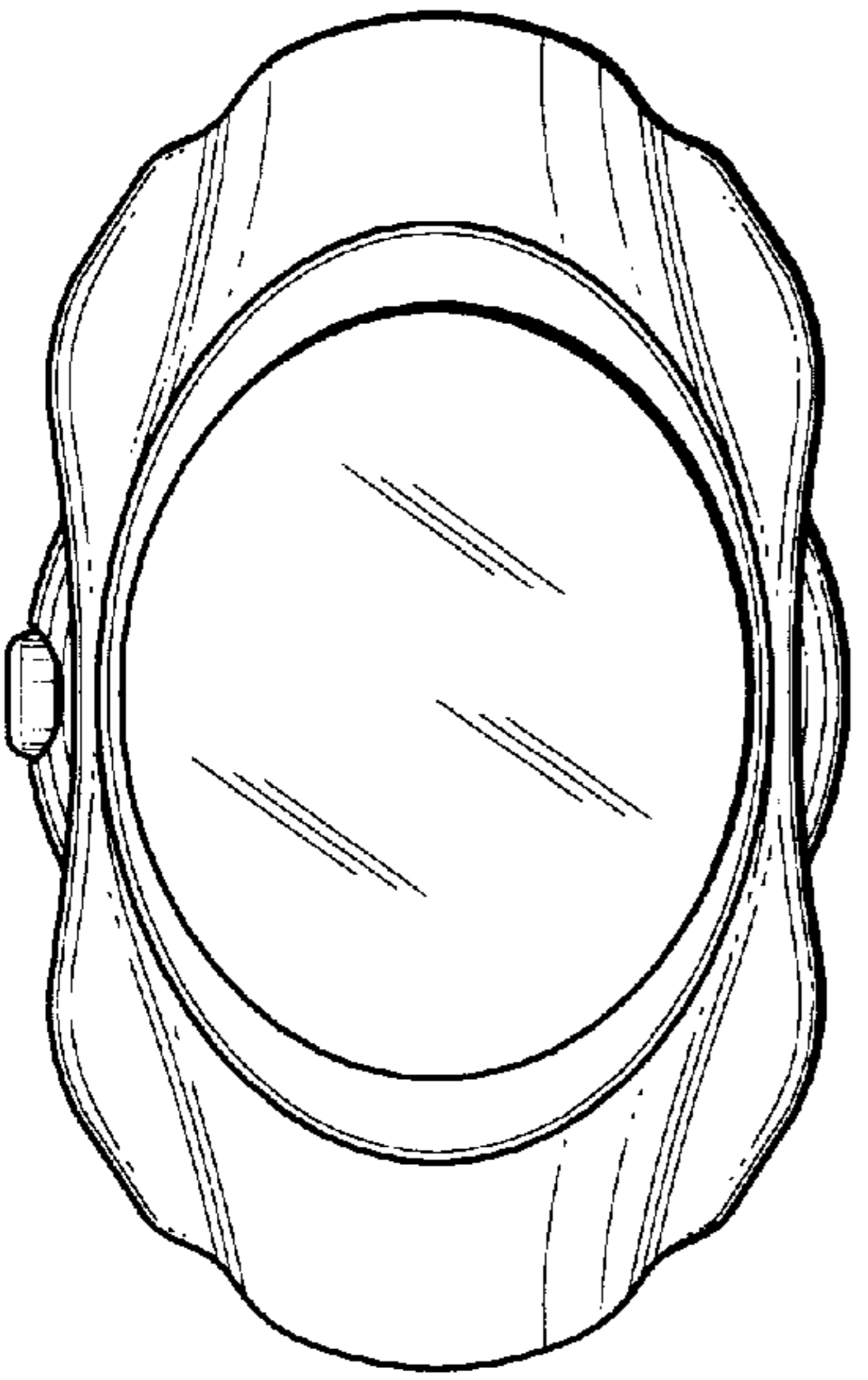

*FIG. 10*

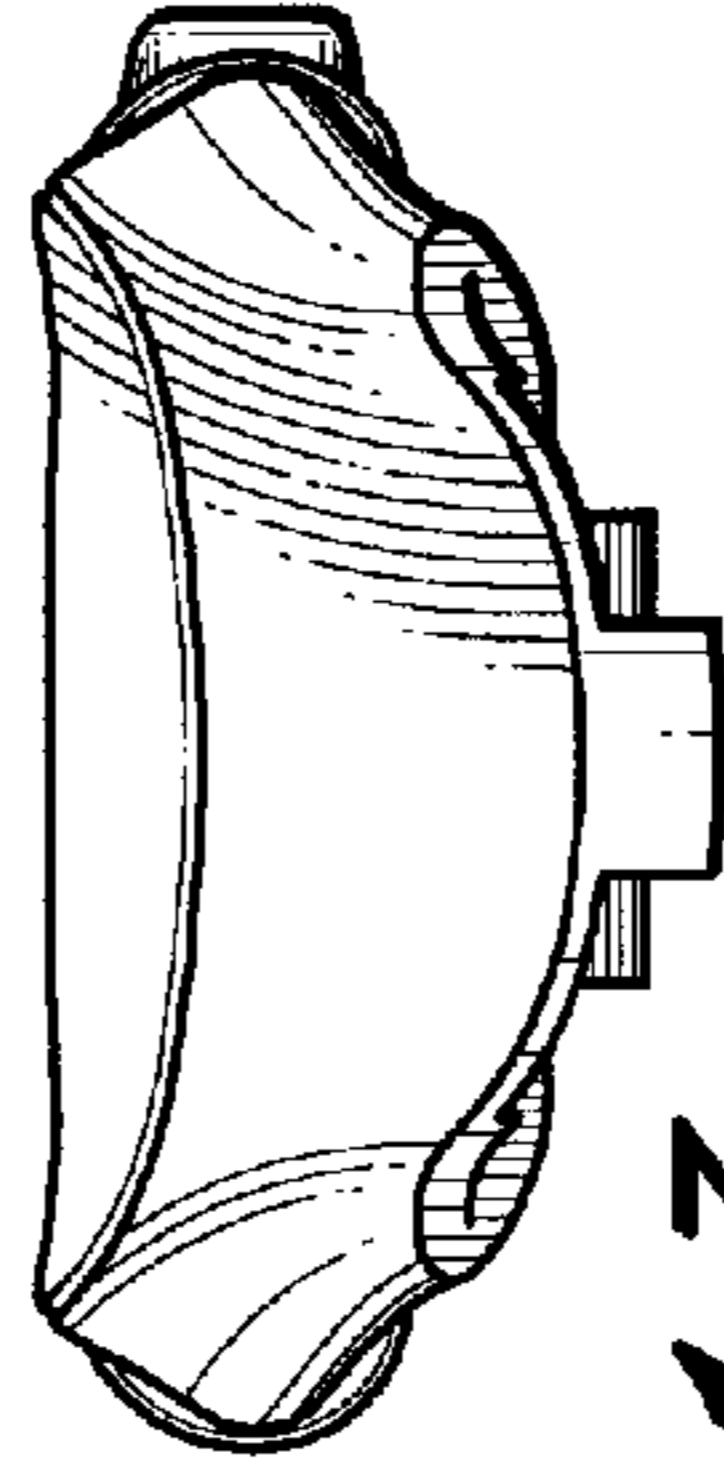

*FIG. 11*

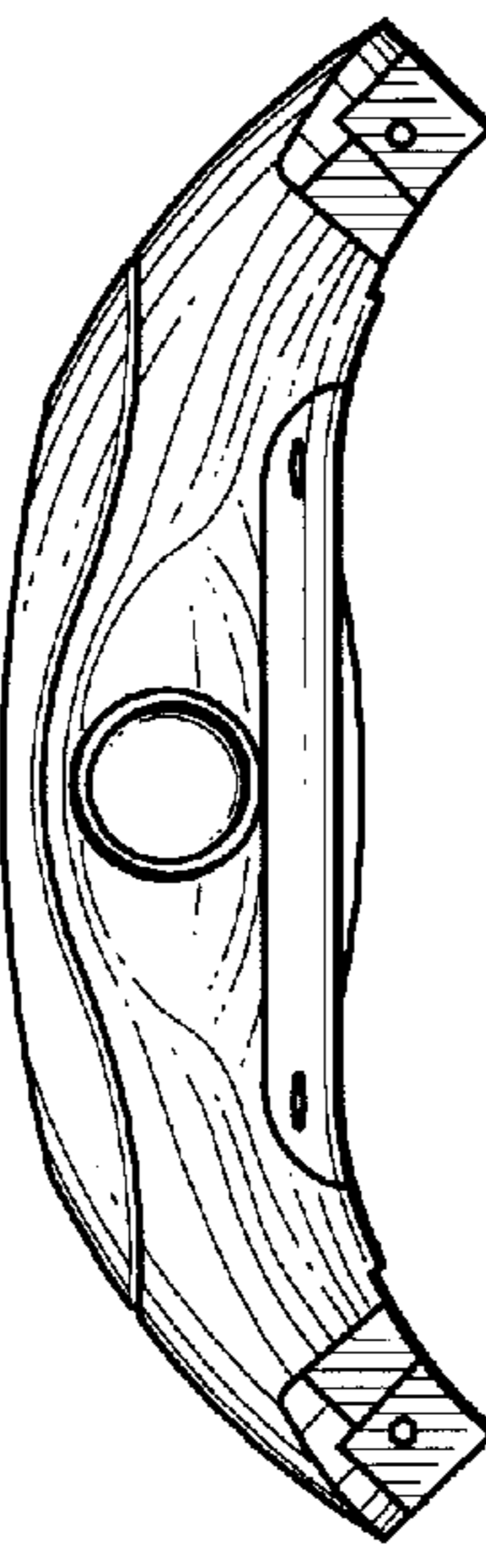

*FIG. 12*

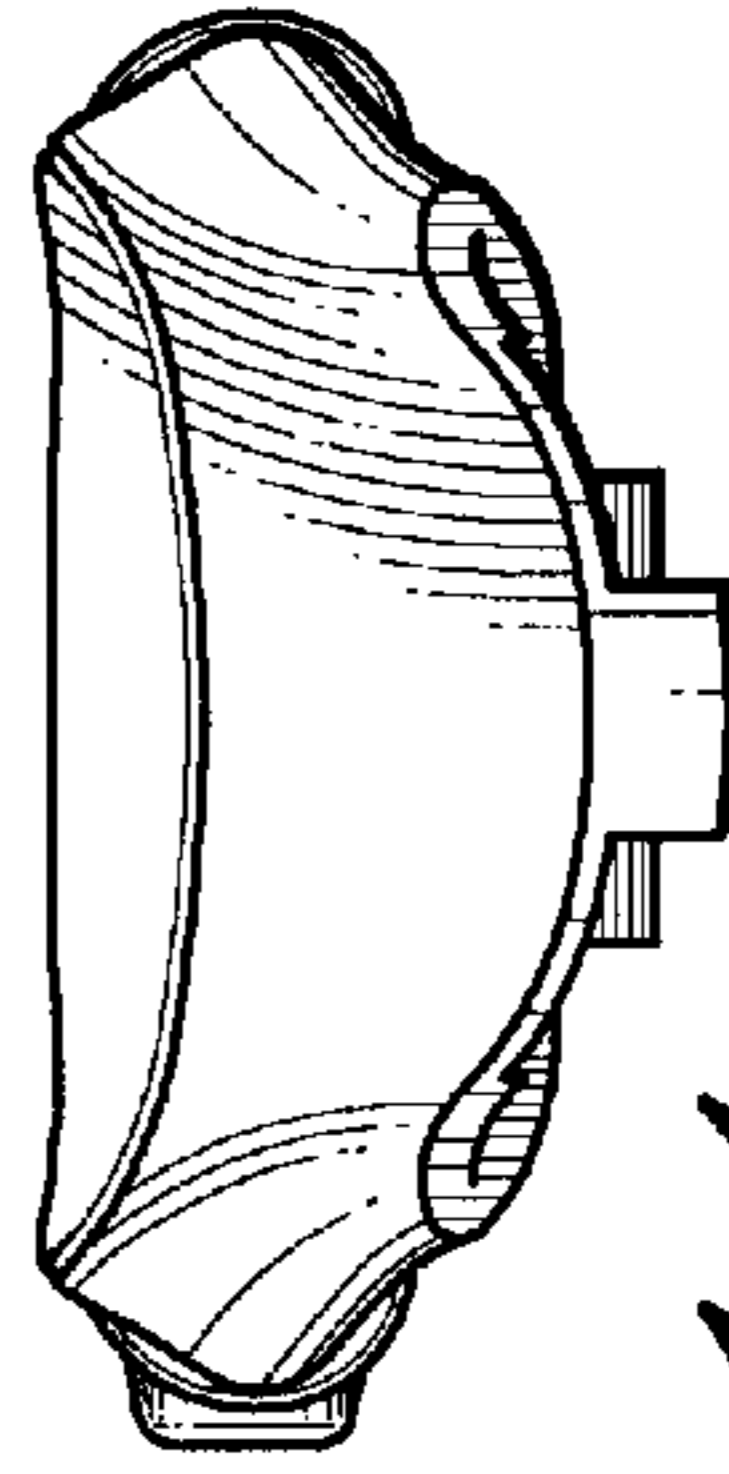

*FIG. 13*

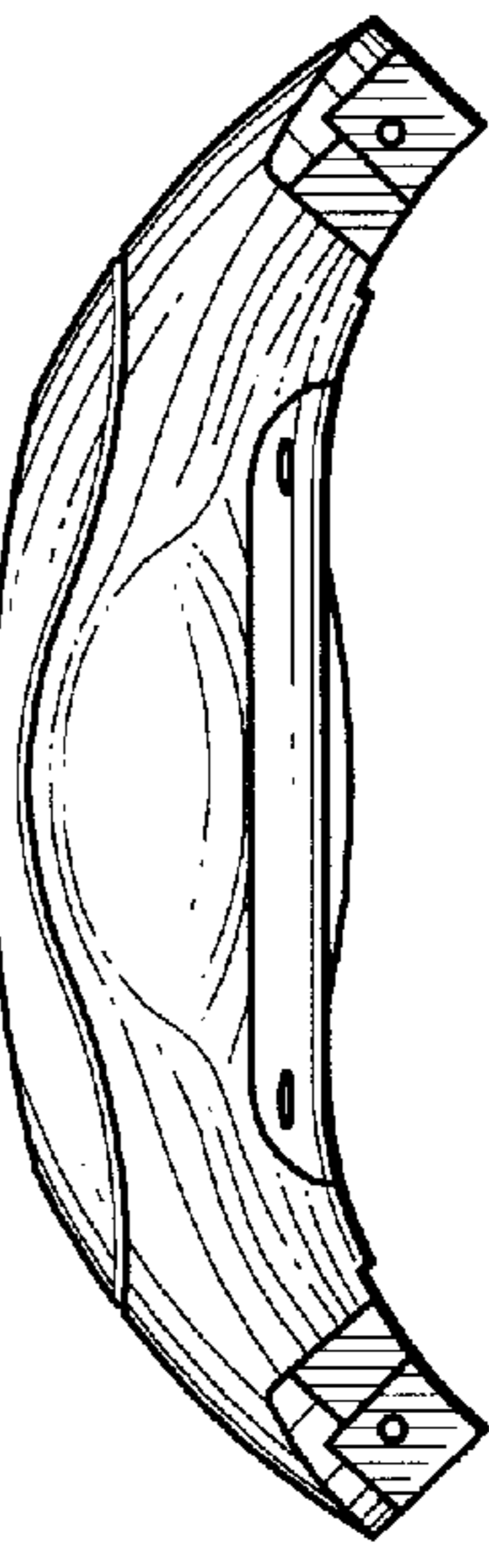

*FIG. 14*