



US00D423930S

United States Patent [19] Rondolino

[11] Patent Number: **Des. 423,930**

[45] Date of Patent: **** *May 2, 2000**

[54] CONTAINER FOR FOOD PRODUCTS

[75] Inventor: **Andrea Rondolino**, Asti, Italy

[73] Assignee: **Il Poggio Di Vaglierano S.A.S. Di Rondolino A. E C.**, Turin, Italy

[*] Notice: This patent is subject to a terminal disclaimer.

[**] Term: **14 Years**

[21] Appl. No.: **29/106,697**

[22] Filed: **Jun. 22, 1999**

[30] **Foreign Application Priority Data**

Dec. 22, 1998 [IT] Italy T09800327

[51] LOC (7) Cl. **09-03**

[52] U.S. Cl. **D9/430**

[58] Field of Search D7/602, 610, 629;
D9/414, 430-433, 438; 206/270, 276; 229/107,
149, 245

[56] **References Cited**

U.S. PATENT DOCUMENTS

D. 57,707	4/1921	Morrison	D9/430
D. 260,487	9/1981	Grubman et al.	D9/432
D. 274,603	7/1984	Lien et al.	D9/431
D. 349,050	7/1994	Krupa	D9/430
883,734	4/1908	Morrison	D9/433

1,158,046	10/1915	Haines	229/107
2,130,445	9/1938	Bemiss	229/939
2,452,969	11/1948	Victor	229/107
2,789,608	4/1957	Tupper	D7/610
3,715,050	2/1973	Batchelar et al.	220/270
3,876,131	4/1975	Tolaas	206/551
3,908,523	9/1975	Shikaya	229/939
4,373,636	2/1983	Hoffman	229/107
4,784,273	11/1988	Niemetz	229/107
4,801,075	1/1989	Weber et al.	206/551
4,990,345	2/1991	Webb	D7/629

Primary Examiner—Ted Shooman
Assistant Examiner—Carol Rademaker
Attorney, Agent, or Firm—Sughrue, Mion, Zinn, Macpeak & Seas, PLLC

[57] **CLAIM**

I claim the ornamental design for a container for food products, as shown and described.

DESCRIPTION

FIG. 1 is a perspective view of the container for food products showing my new design;
FIG. 2 is a front view thereof;
FIG. 3 is a right view thereof;
FIG. 4 is a left view thereof;
FIG. 5 is a rear view thereof;
FIG. 6 is a top view thereof; and,
FIG. 7 is a bottom view thereof.

1 Claim, 2 Drawing Sheets

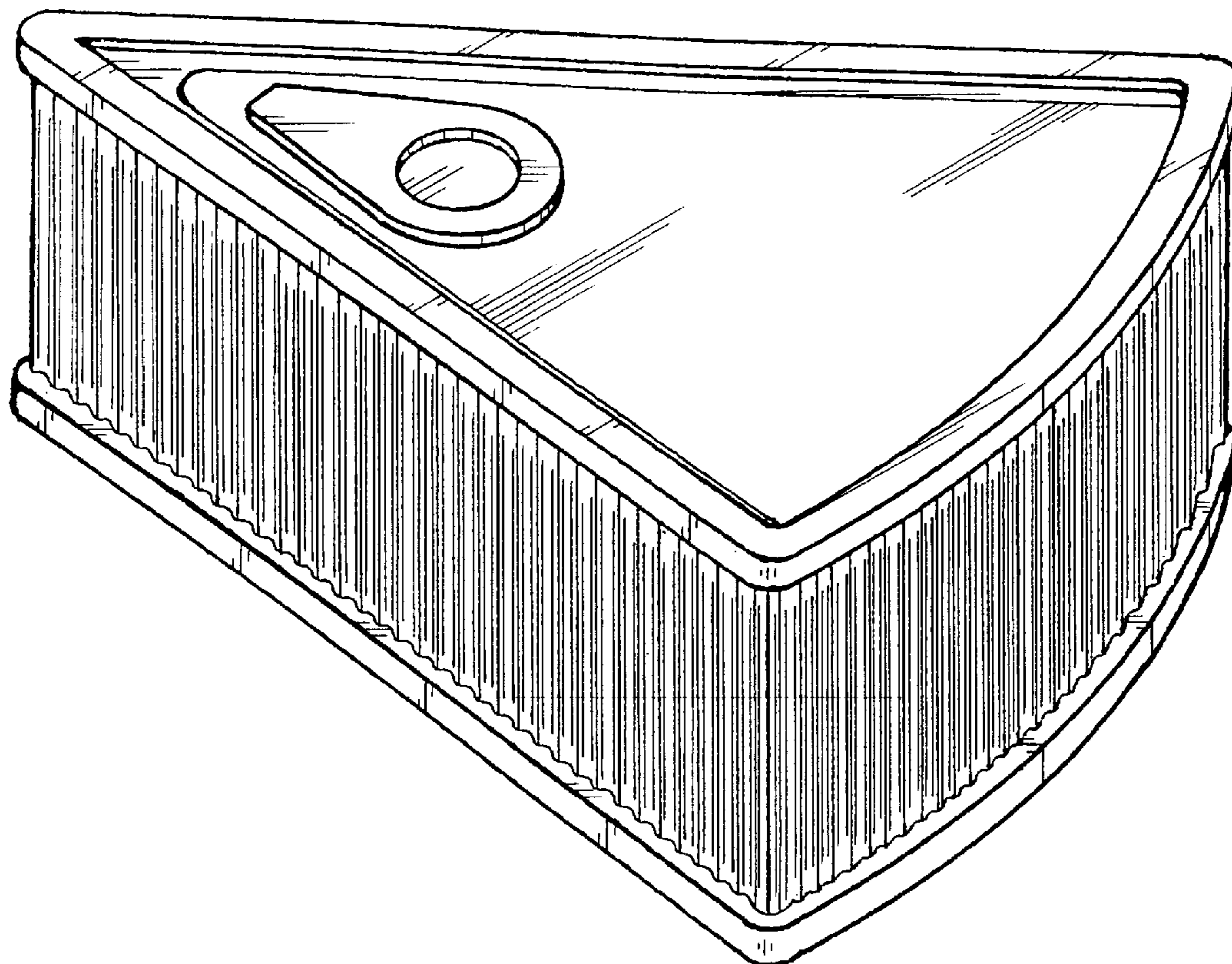

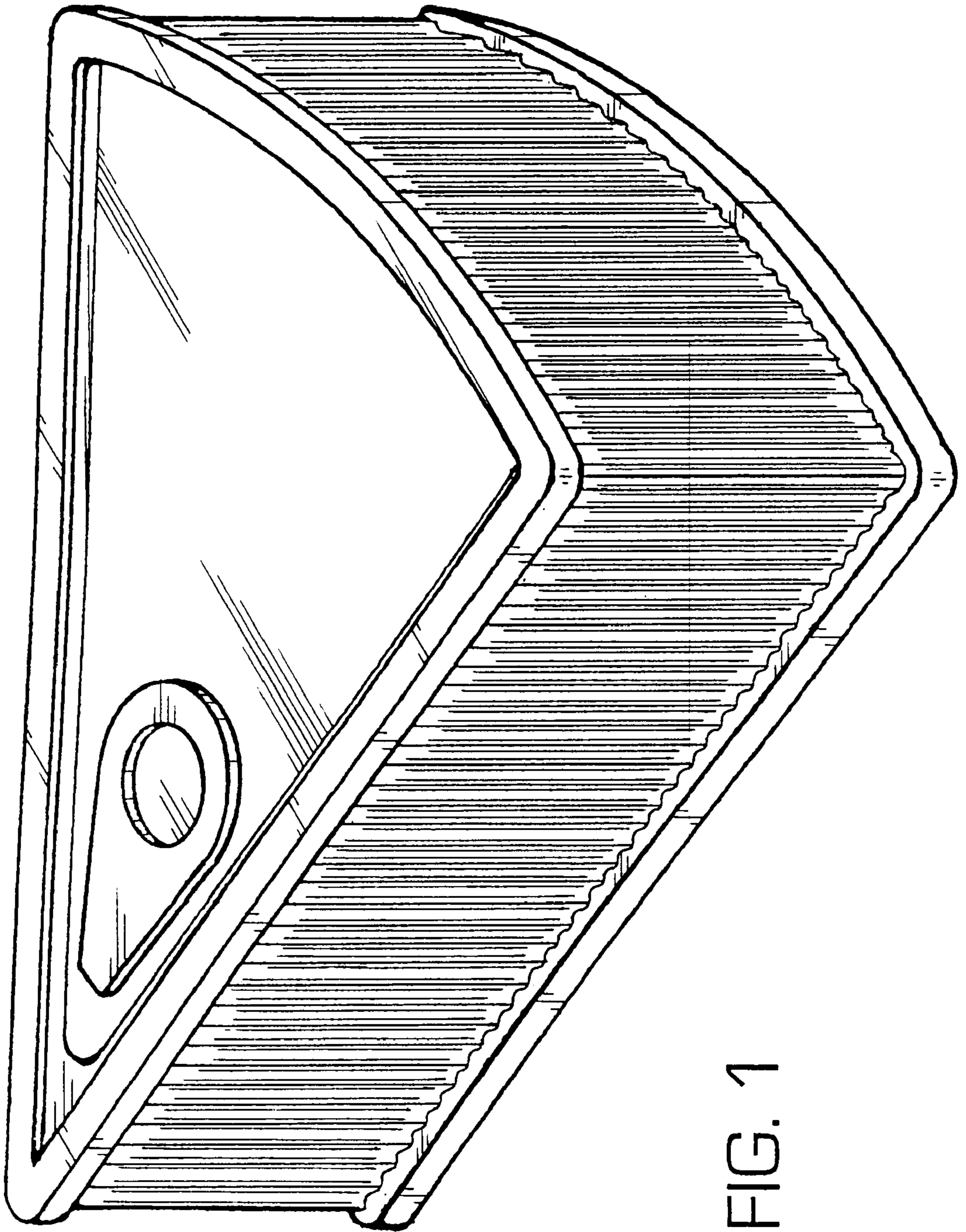

FIG. 1

FIG. 2

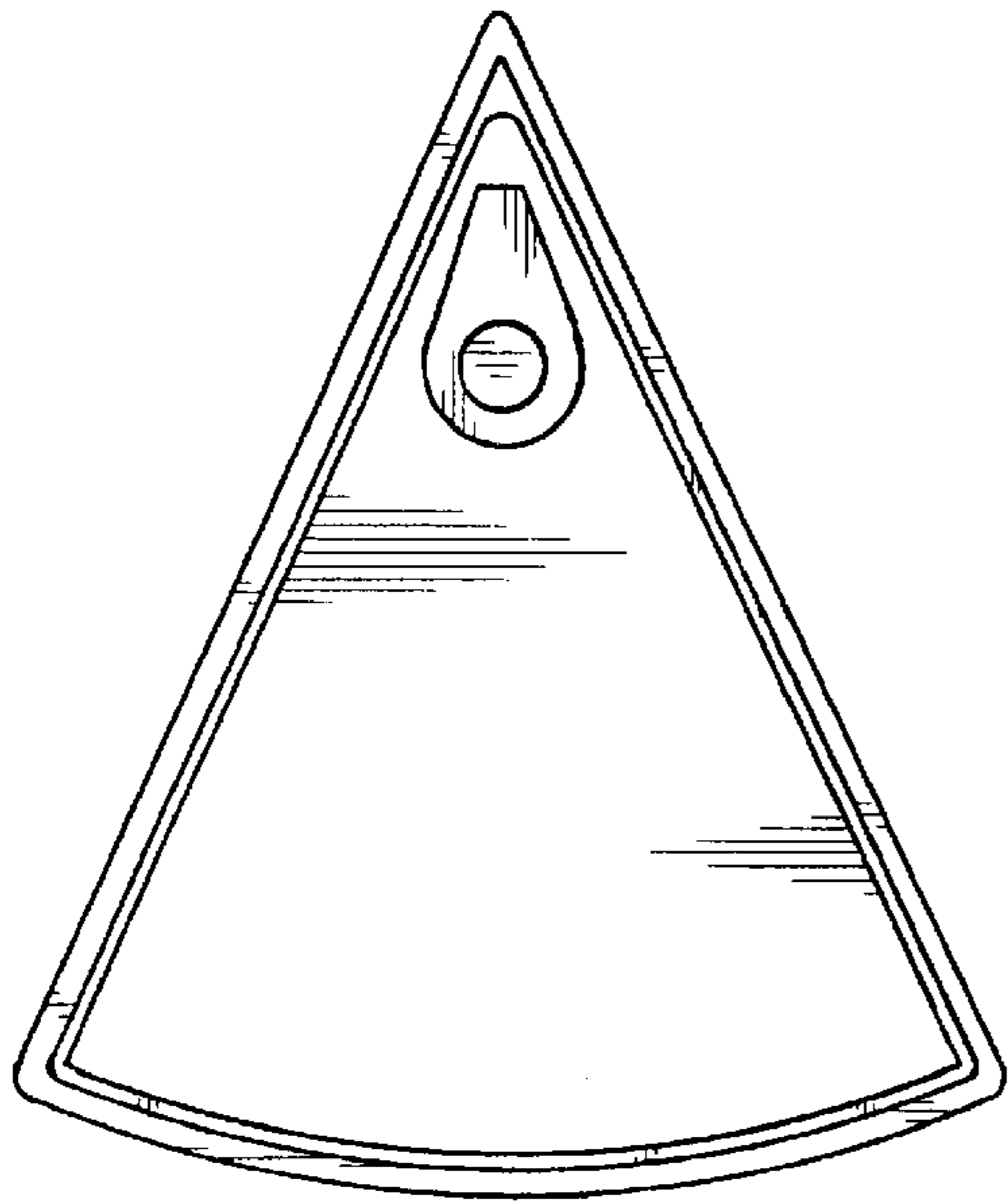

FIG. 3

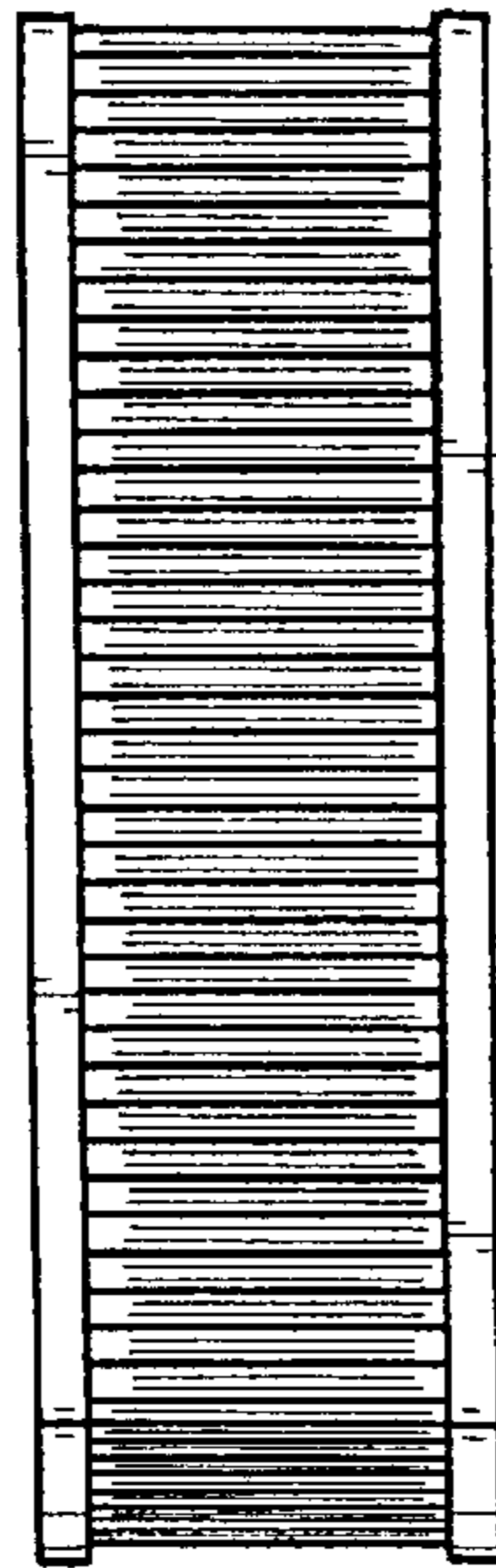

FIG. 4

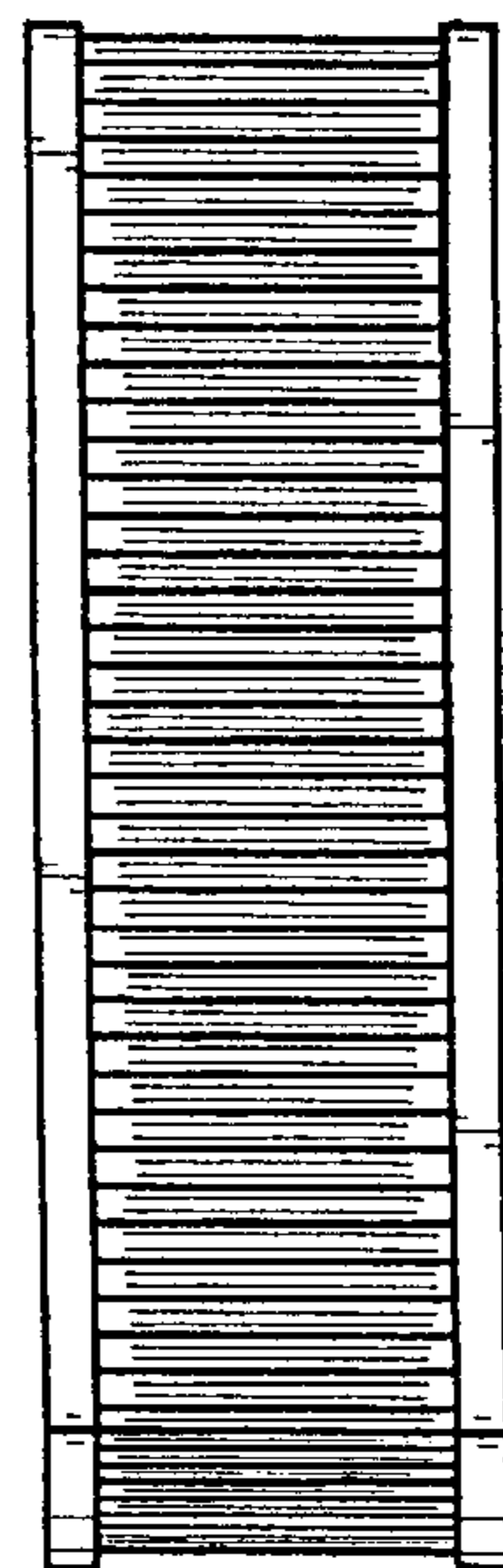

FIG. 5

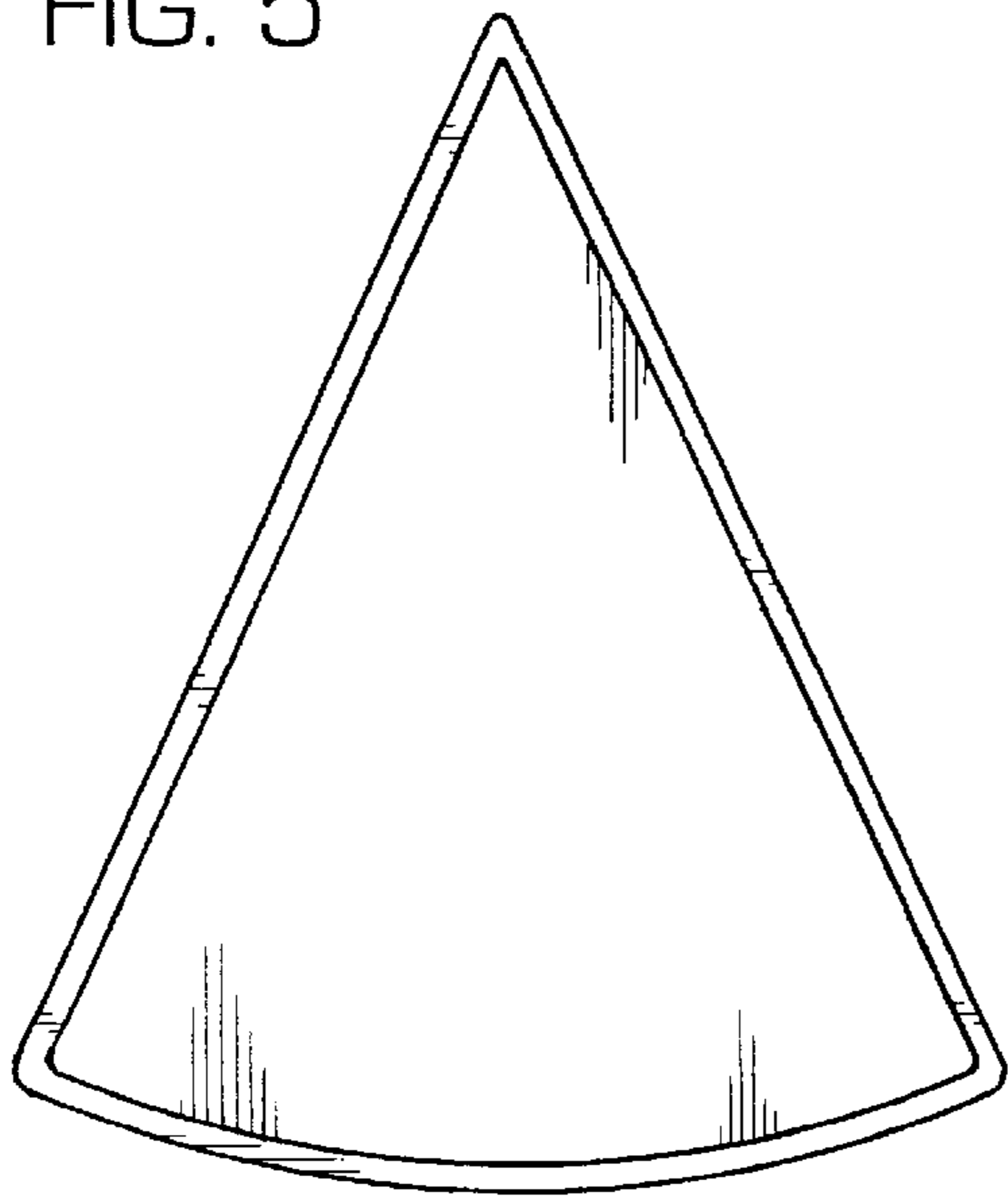

FIG. 6

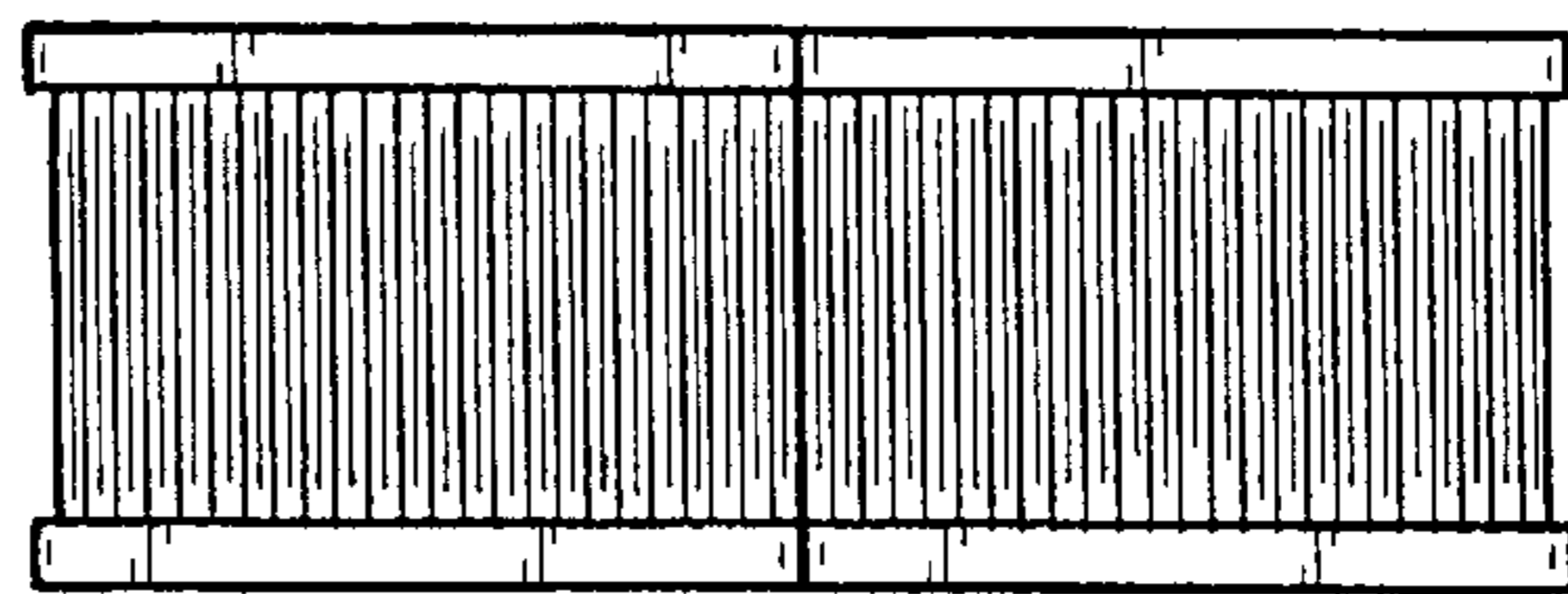

FIG. 7

