



US00D423925S

United States Patent [19]

[11] **Patent Number: Des. 423,925**

Finkelston et al.

[45] **Date of Patent: ** May 2, 2000**

[54] **DIAL PACK TABLET DISPENSER**

DESCRIPTION

[75] Inventors: **Paul R. Finkelston**, Philadelphia;
Marty L. Shampoe, Edinboro, both of Pa.

[73] Assignee: **American Home Products Corporation**, Madison, N.J.

[**] Term: **14 Years**

[21] Appl. No.: **29/091,064**

[22] Filed: **Jul. 22, 1998**

[51] **LOC (7) Cl.** **09-03**

[52] **U.S. Cl.** **D9/339**

[58] **Field of Search** D9/337, 339, 341,
D9/345-348, 414, 418, 430-432, 441; 206/530-531,
533-534, 538-539

[56] **References Cited**

U.S. PATENT DOCUMENTS

D. 193,119	6/1962	Bostrom	D9/341
D. 198,542	6/1964	Tapper	D9/339
D. 209,853	1/1968	Barton et al.	.	
D. 318,418	7/1991	Dwyer	.	
D. 335,081	4/1993	Pierantozzi et al.	.	
D. 380,378	7/1997	Wood	D9/339
D. 405,361	2/1999	Cameron et al.	D9/339
2,901,858	9/1959	Pinkerton et al.	206/539
3,288,277	11/1966	Hallerbach	D9/339
3,533,371	10/1970	Gronemeyer et al.	206/533
3,570,707	3/1971	Finkel	D9/341
3,572,282	3/1971	Tump et al.	206/533

(List continued on next page.)

Primary Examiner—Ted Shooman
Assistant Examiner—Carol Rademaker
Attorney, Agent, or Firm—Steven R. Eck; Arthur G. Seifert

[57] **CLAIM**

The ornamental design for a dial pack tablet dispenser, as shown and described.

FIG. 1 is a top front right perspective of the dial pack tablet dispenser;
 FIG. 2 is a bottom right front perspective;
 FIG. 3 is a top view;
 FIG. 4 is a bottom view;
 FIG. 5 is a front view;
 FIG. 6 is a rear view;
 FIG. 7 is a right side view;
 FIG. 8 is a left side view;
 FIG. 9 is a top front right perspective with the cover removed;
 FIG. 10 is a bottom front right perspective with the cover removed;
 FIG. 11 is a top view with the cover removed;
 FIG. 12 is a front view with the cover removed;
 FIG. 13 is a rear view with the cover removed;
 FIG. 14 is a right side view with the cover removed; and
 FIG. 15 is a left side view with the cover removed.
 FIG. 16 is a top right front perspective view of the second embodiment of the dial pack tablet dispenser of FIG. 1 wherein the tablet cavities are of equal size;
 FIG. 17 is a top view of the second embodiment;
 FIG. 18 is a front view of the second embodiment;
 FIG. 19 is a rear view of the second embodiment;
 FIG. 20 is a right side view of a second embodiment, the left side view being a mirror image thereof;
 FIG. 21 is a top front right perspective with the cover removed of the second embodiment;
 FIG. 22 is a bottom front right perspective with the cover removed of the second embodiment;
 FIG. 23 is a top view with the cover removed of the second embodiment;
 FIG. 24 is a front view with the cover removed of the second embodiment;
 FIG. 25 is a rear view with the cover removed of the second embodiment; and,
 FIG. 26 is a right side view with the cover removed of the second embodiment, the left side view being a mirror image thereof.
 The broken line showing of the protective cap in FIGS. 1 and 16 is for illustrative purposes only and forms no part of the claimed design.

1 Claim, 11 Drawing Sheets

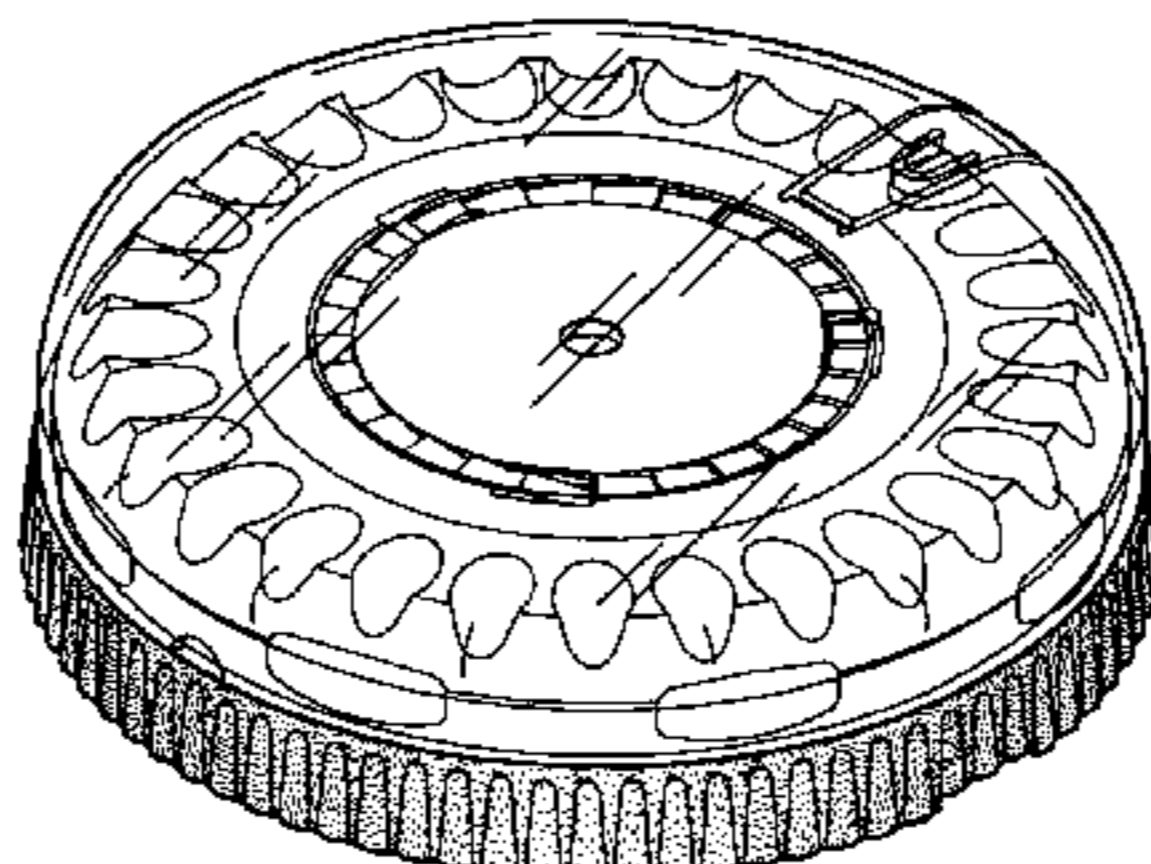
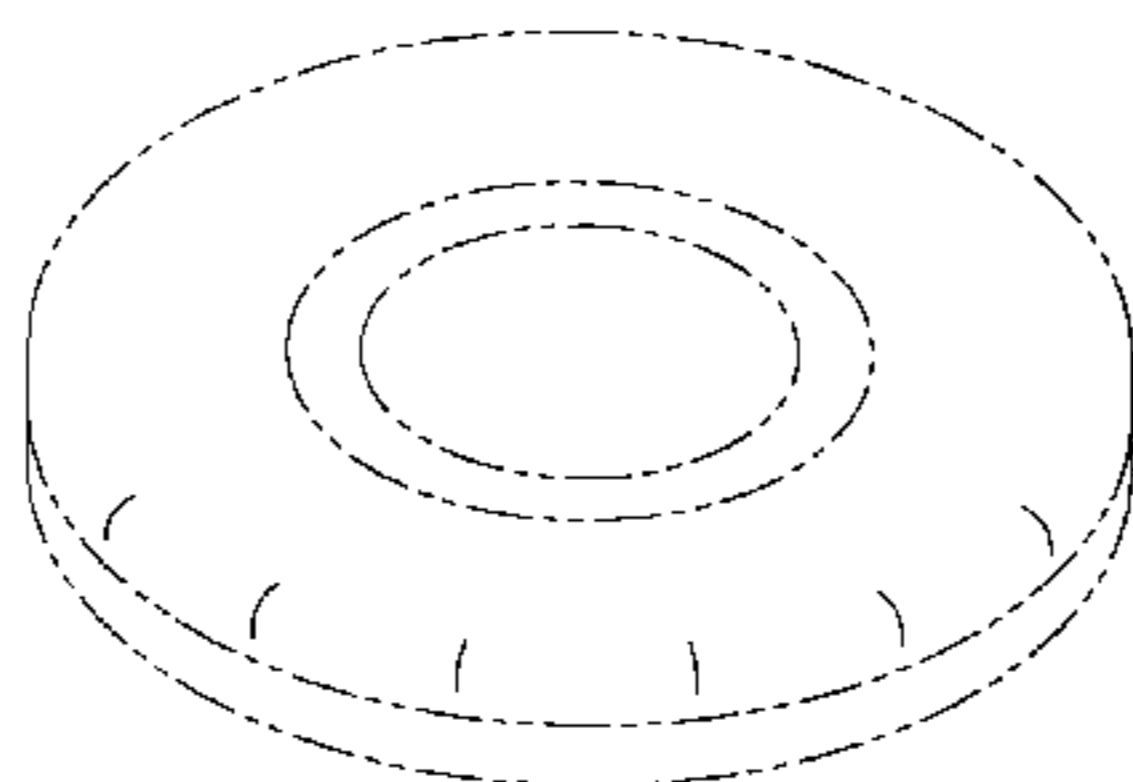

Des. 423,925

Page 2

U.S. PATENT DOCUMENTS

3,604,559	9/1971	McCall et al. .	4,817,819	4/1989	Kelly .	
3,860,113	1/1975	Helms .	4,915,256	4/1990	Tump .	
3,907,145	9/1975	Horvath .	5,020,671	6/1991	Smith et al.	206/534
3,984,031	10/1976	Thompson .	5,154,296	10/1992	Cutler .	
4,032,035	6/1977	Tepas, Jr. et al. .	5,377,614	1/1995	Glazer .	
4,127,190	11/1978	Sunnen .	5,392,952	2/1995	Bowden .	
4,165,709	8/1979	Studer .	5,449,077	9/1995	Seidler .	
4,524,869	6/1985	Nader 206/538	5,562,231	10/1996	Lambelet, Jr. et al. .	
4,613,051	9/1986	Swartzbaugh .	5,570,810	11/1996	Lambelet, Jr. et al. .	
4,646,936	3/1987	Frazier et al. .	5,664,697	9/1997	Lambelet, Jr. et al. .	
4,667,845	5/1987	Frazier et al. .	5,775,536	7/1998	Lambelet, Jr. et al. .	
4,687,113	8/1987	Reeve .	5,799,821	9/1998	Lambelet, Jr. et al. .	
			5,850,919	12/1998	Freed .	

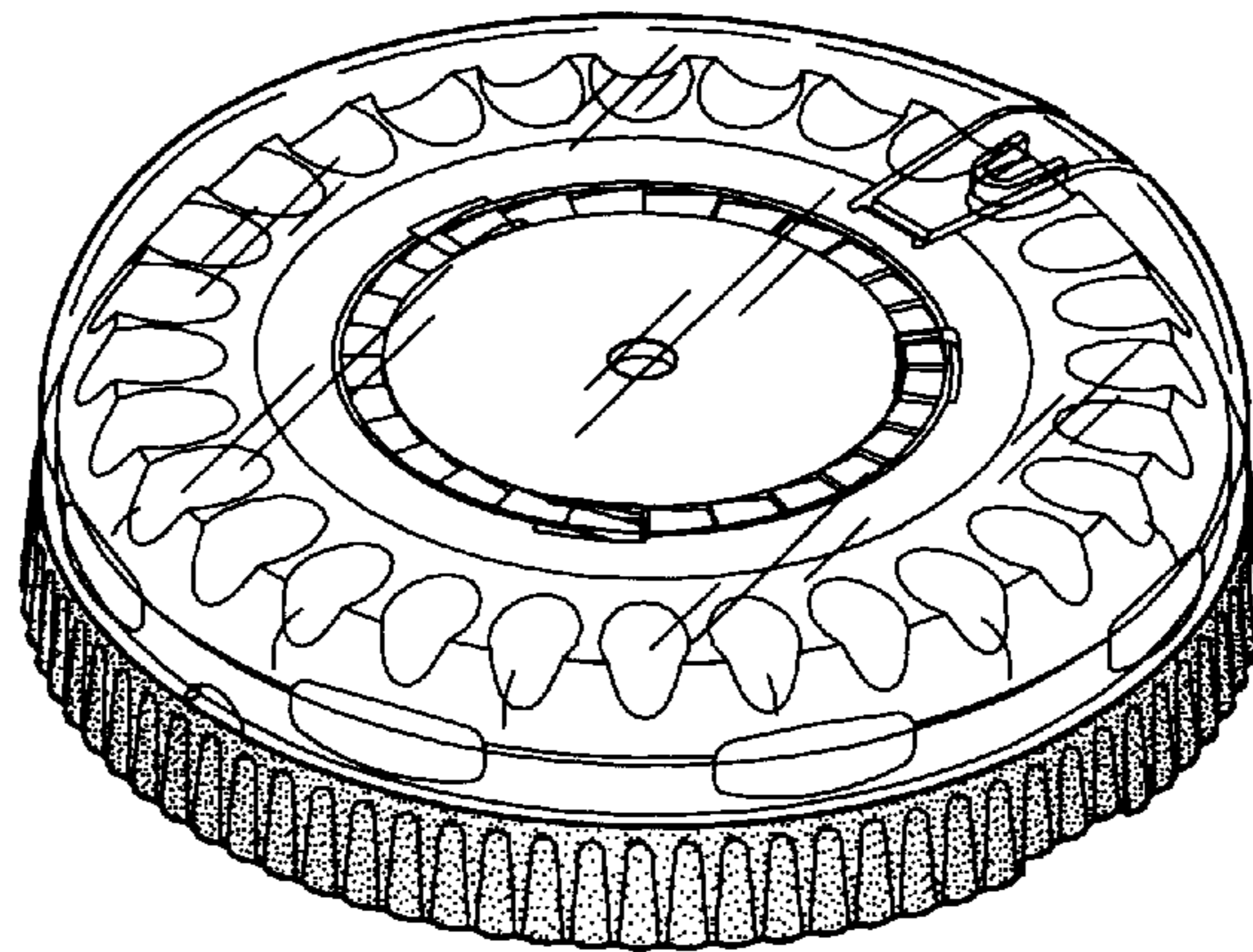
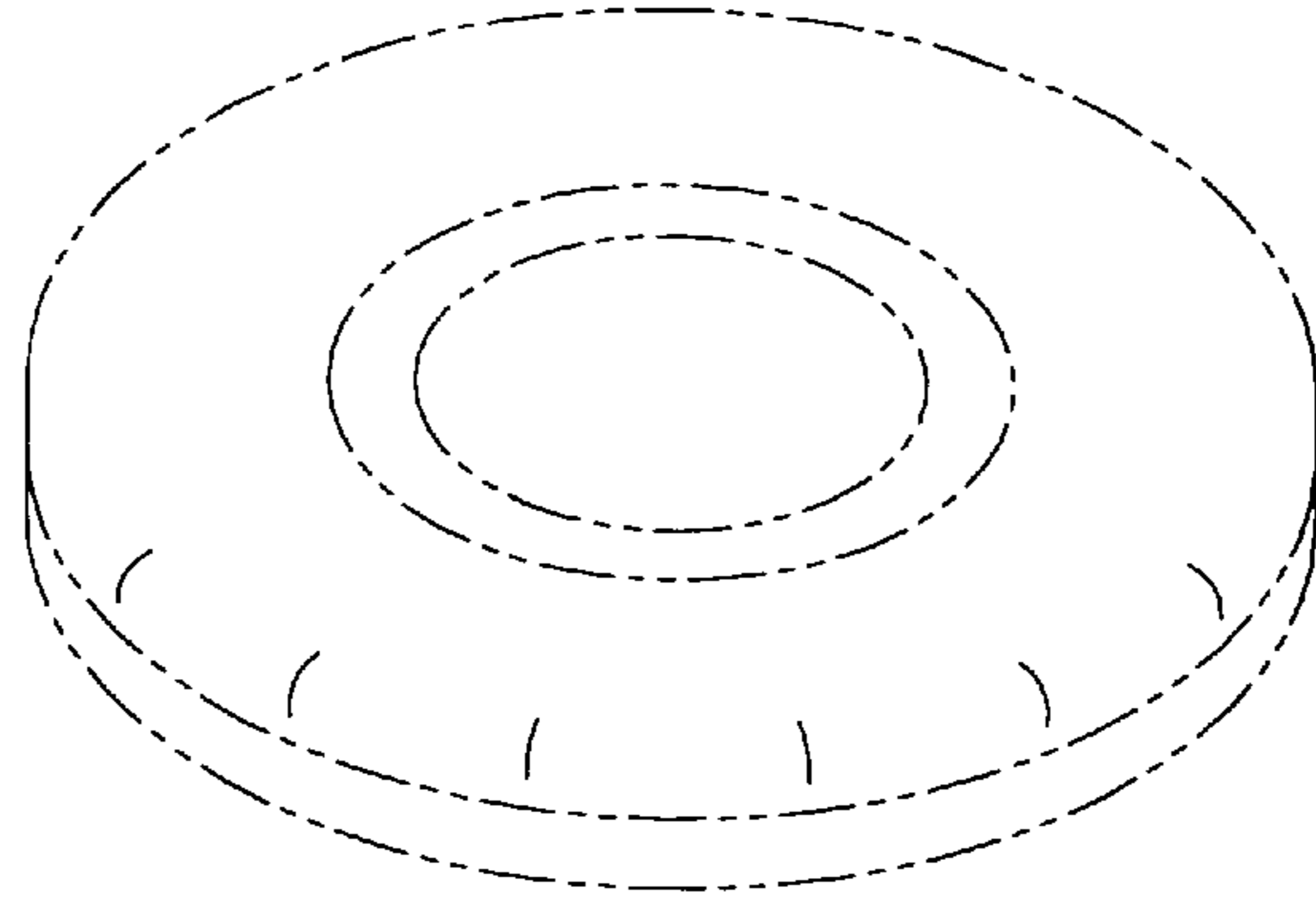

FIG. 1

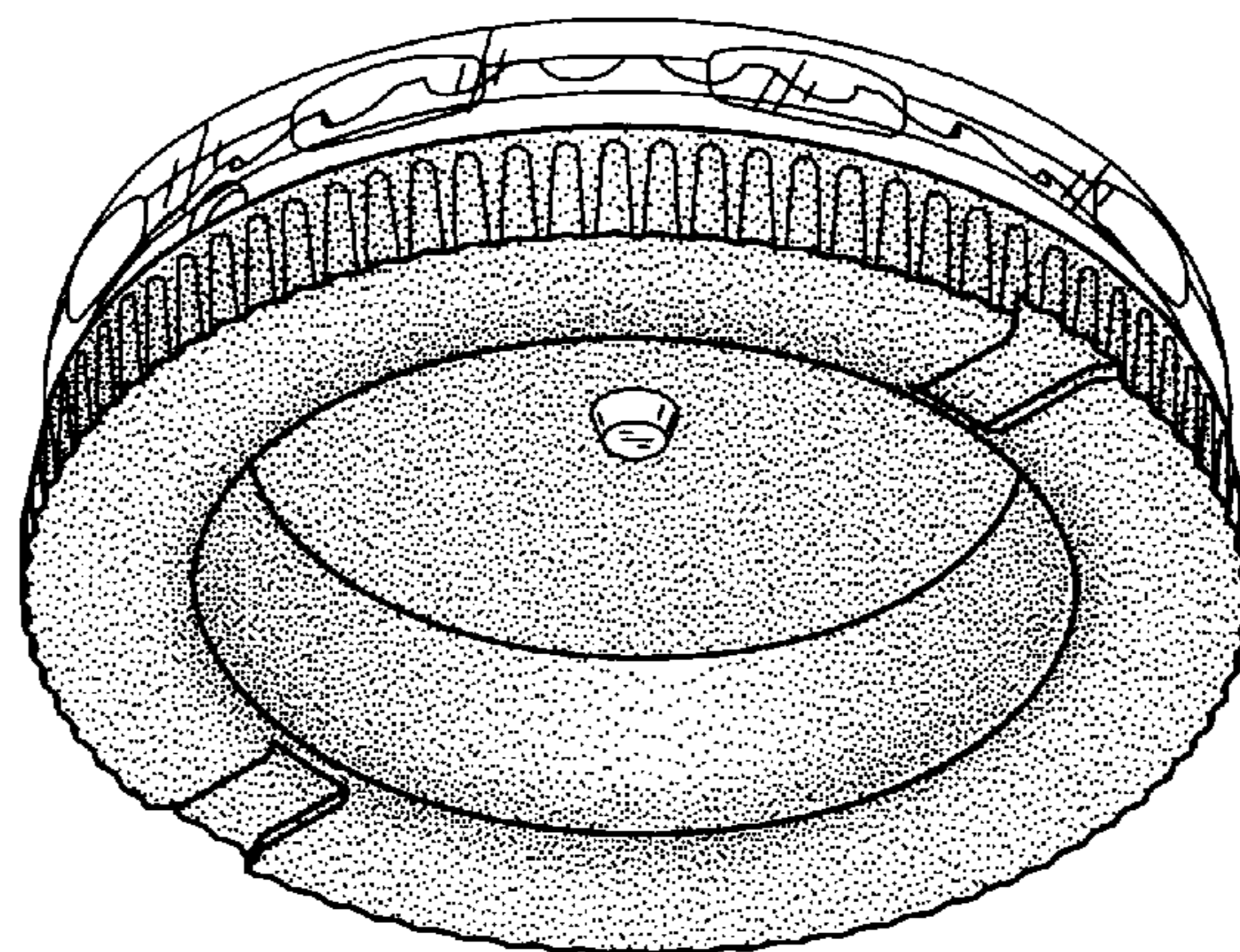

FIG. 2

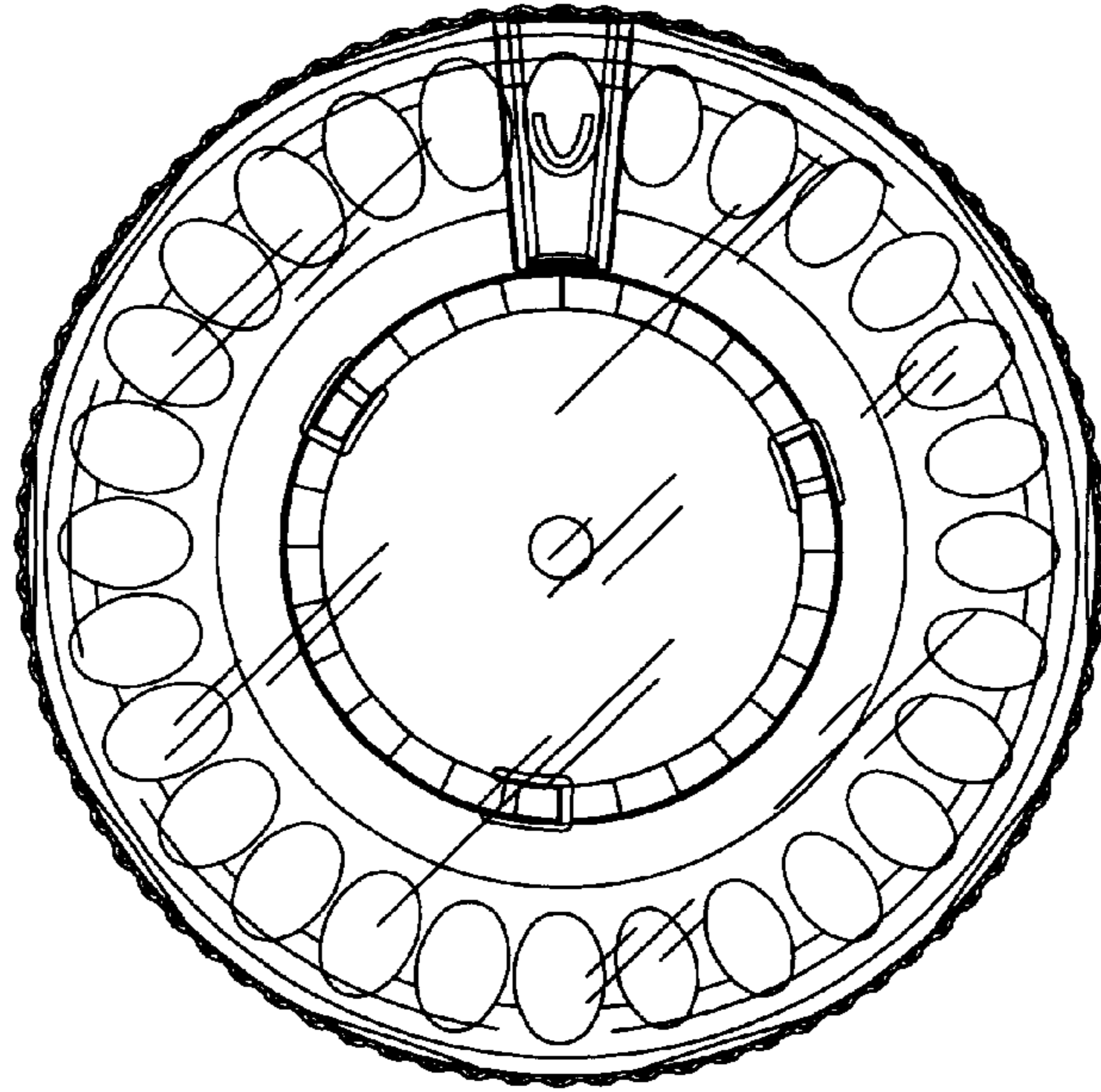

FIG. 3

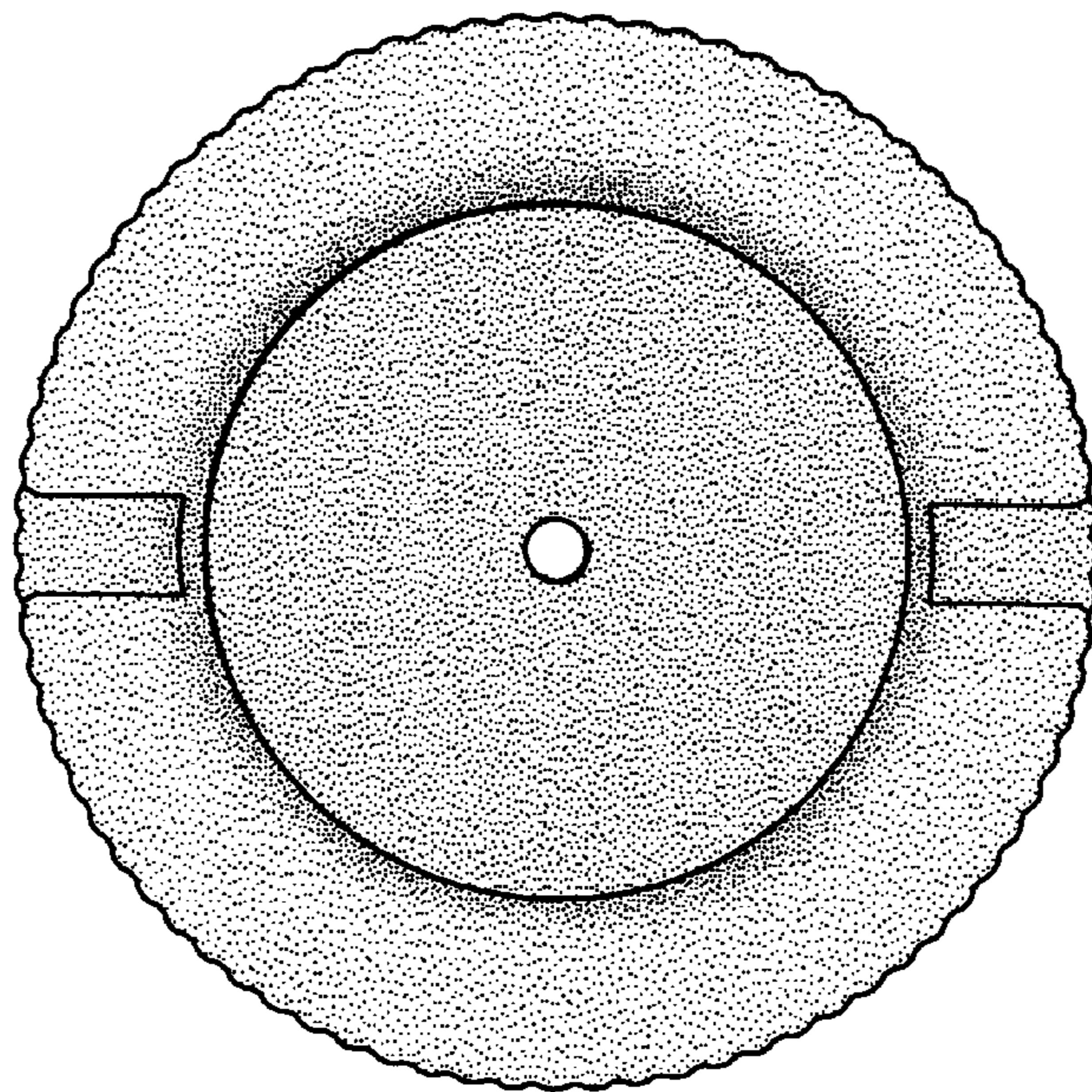

FIG. 4

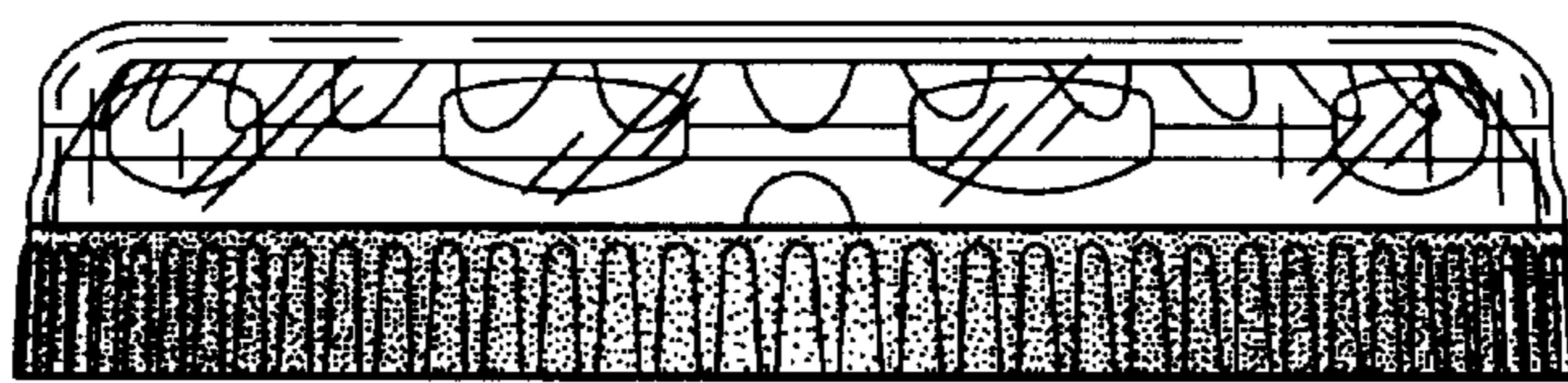

FIG. 5

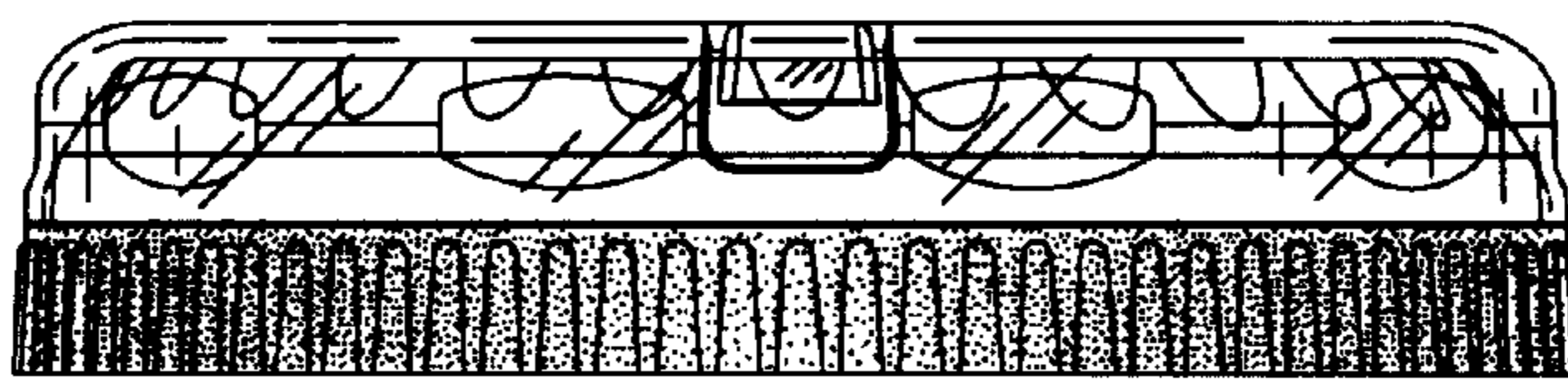

FIG. 6

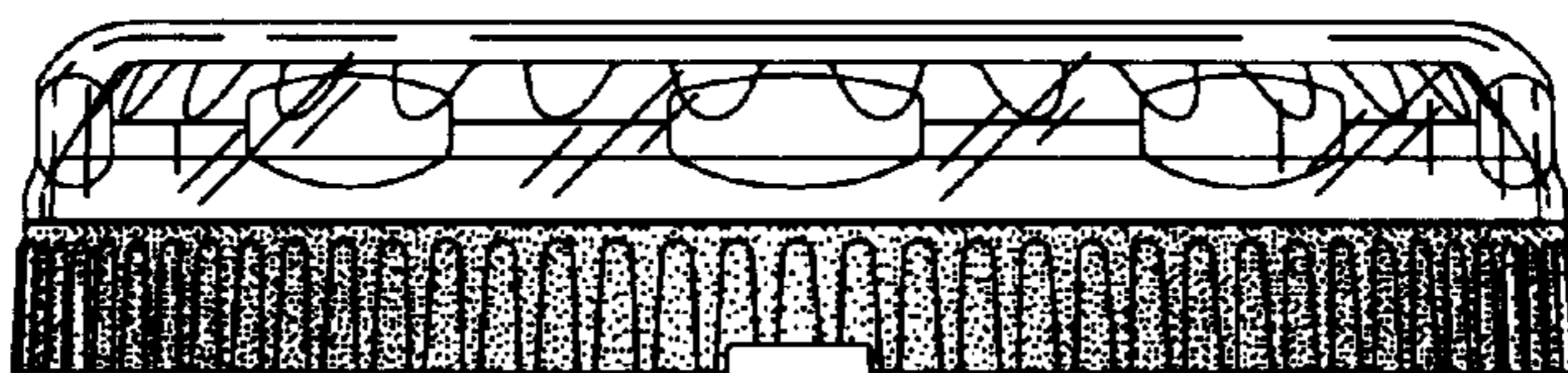

FIG. 7

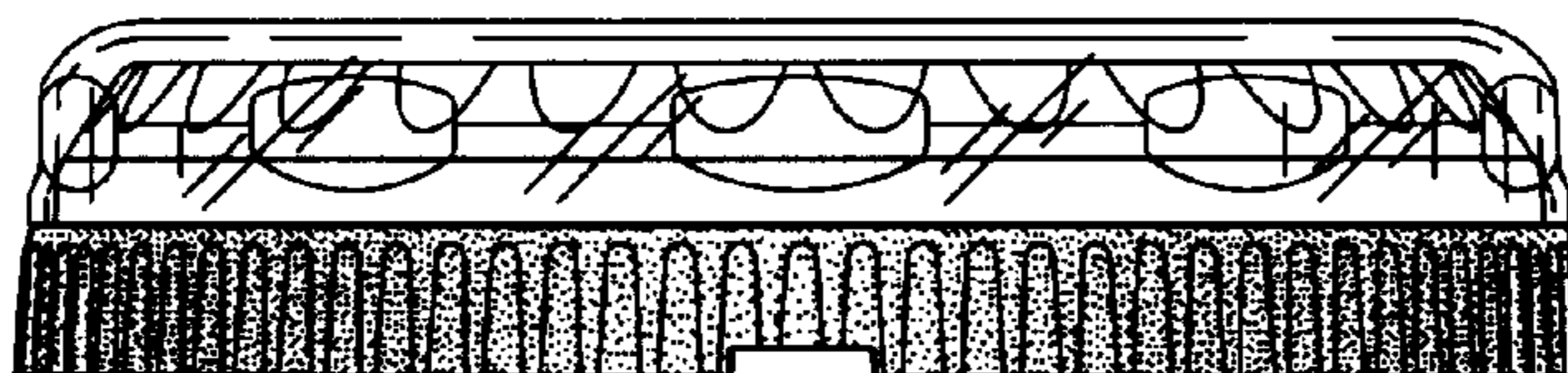

FIG. 8

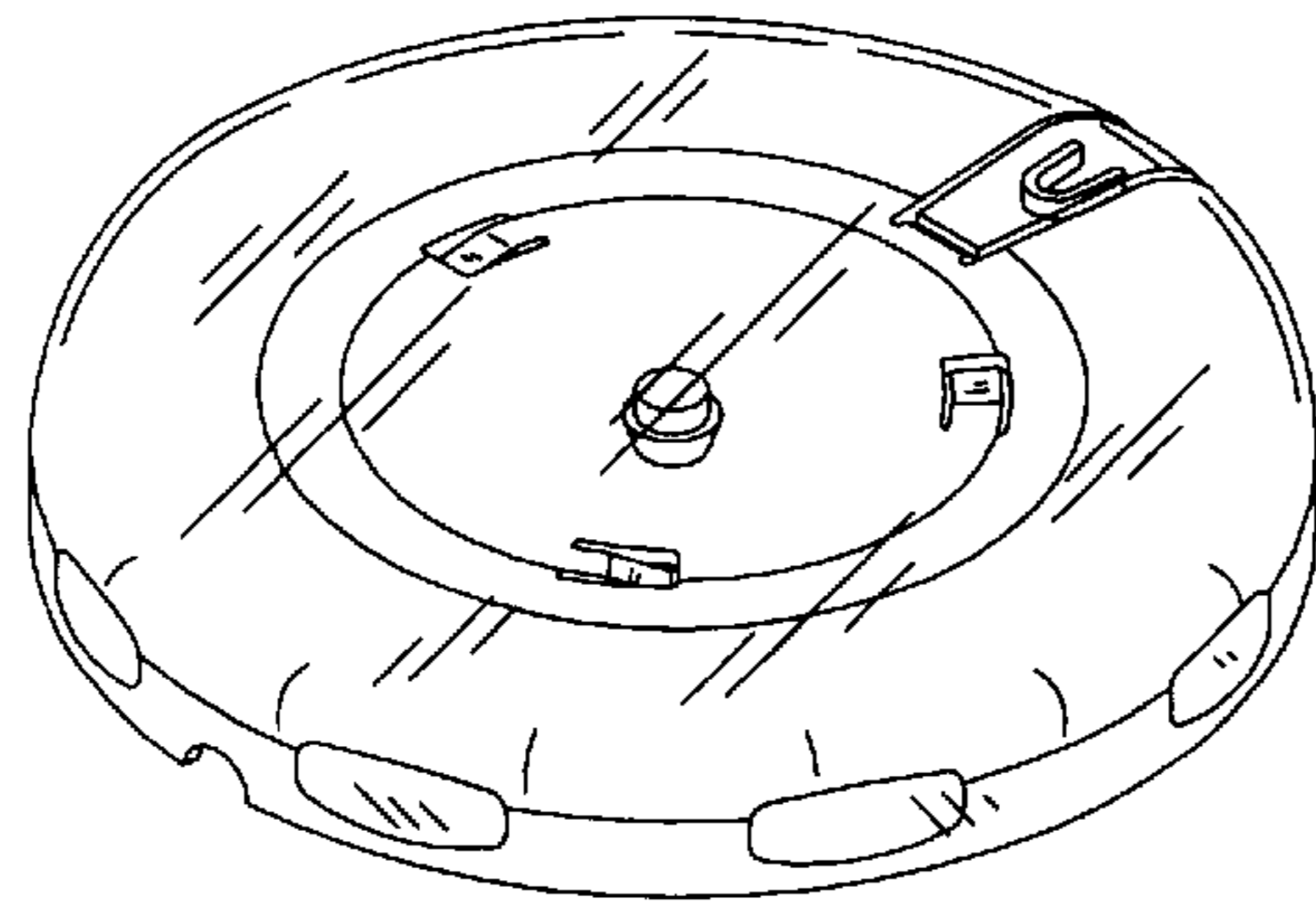

FIG. 9

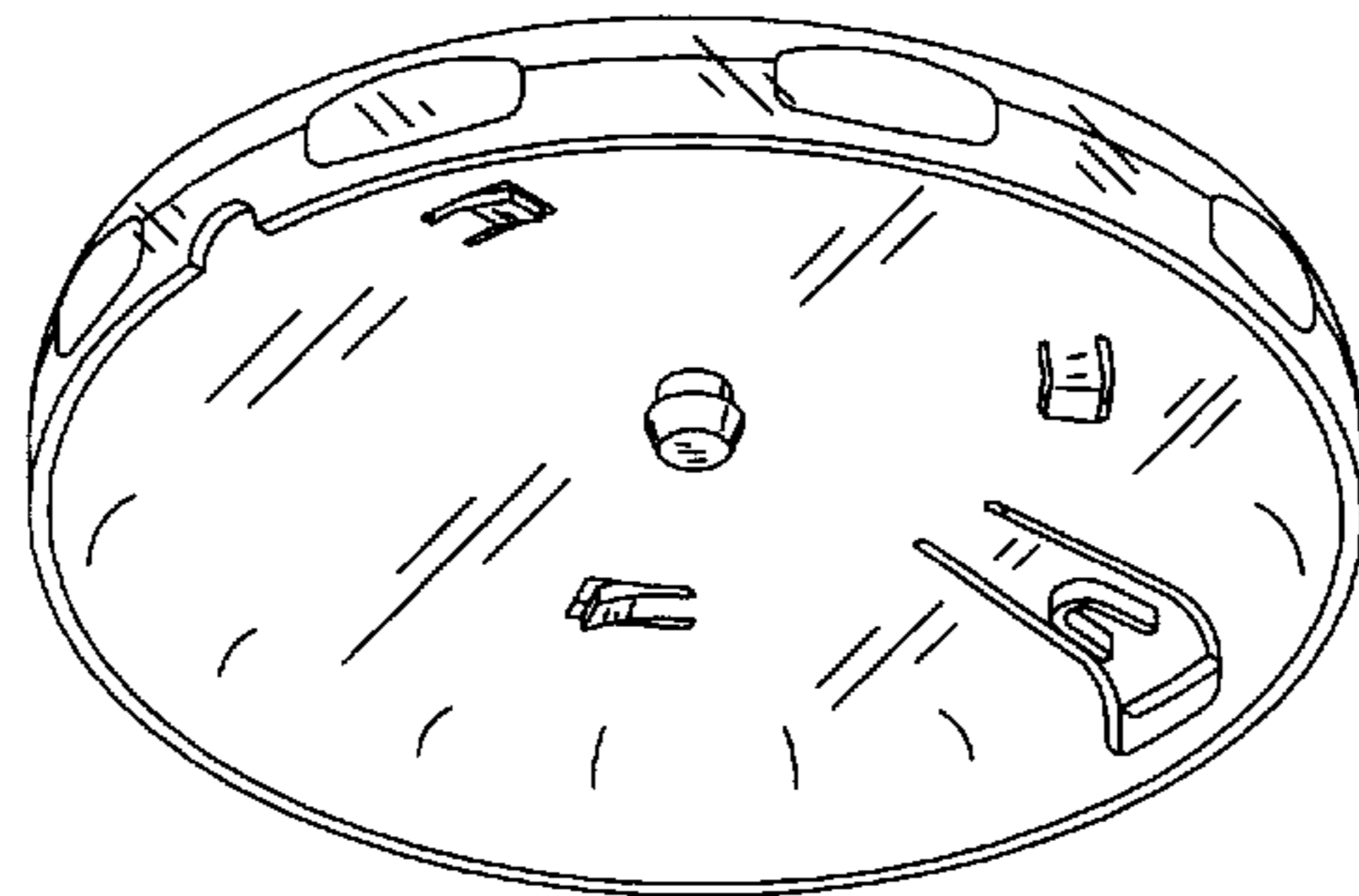
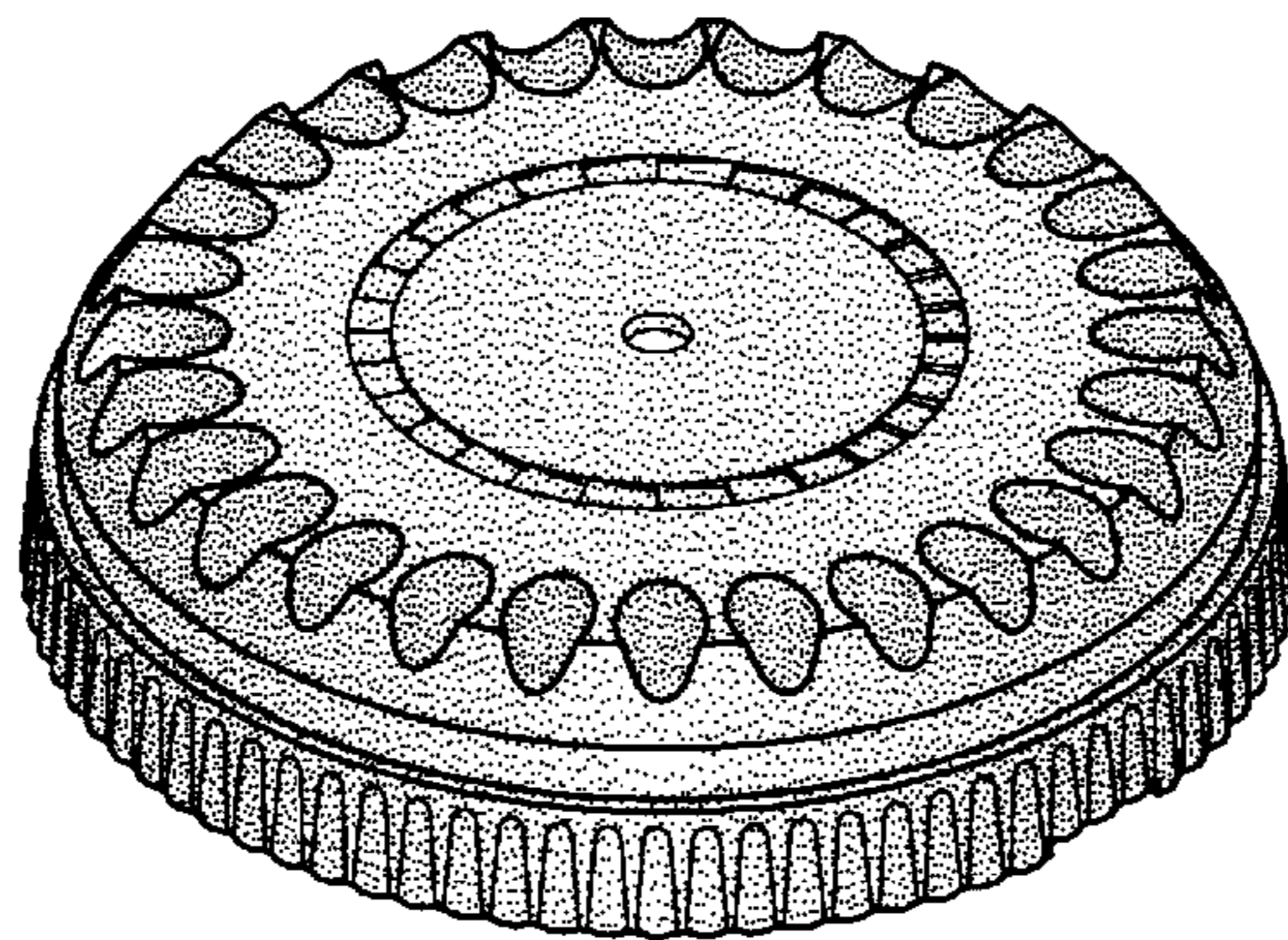
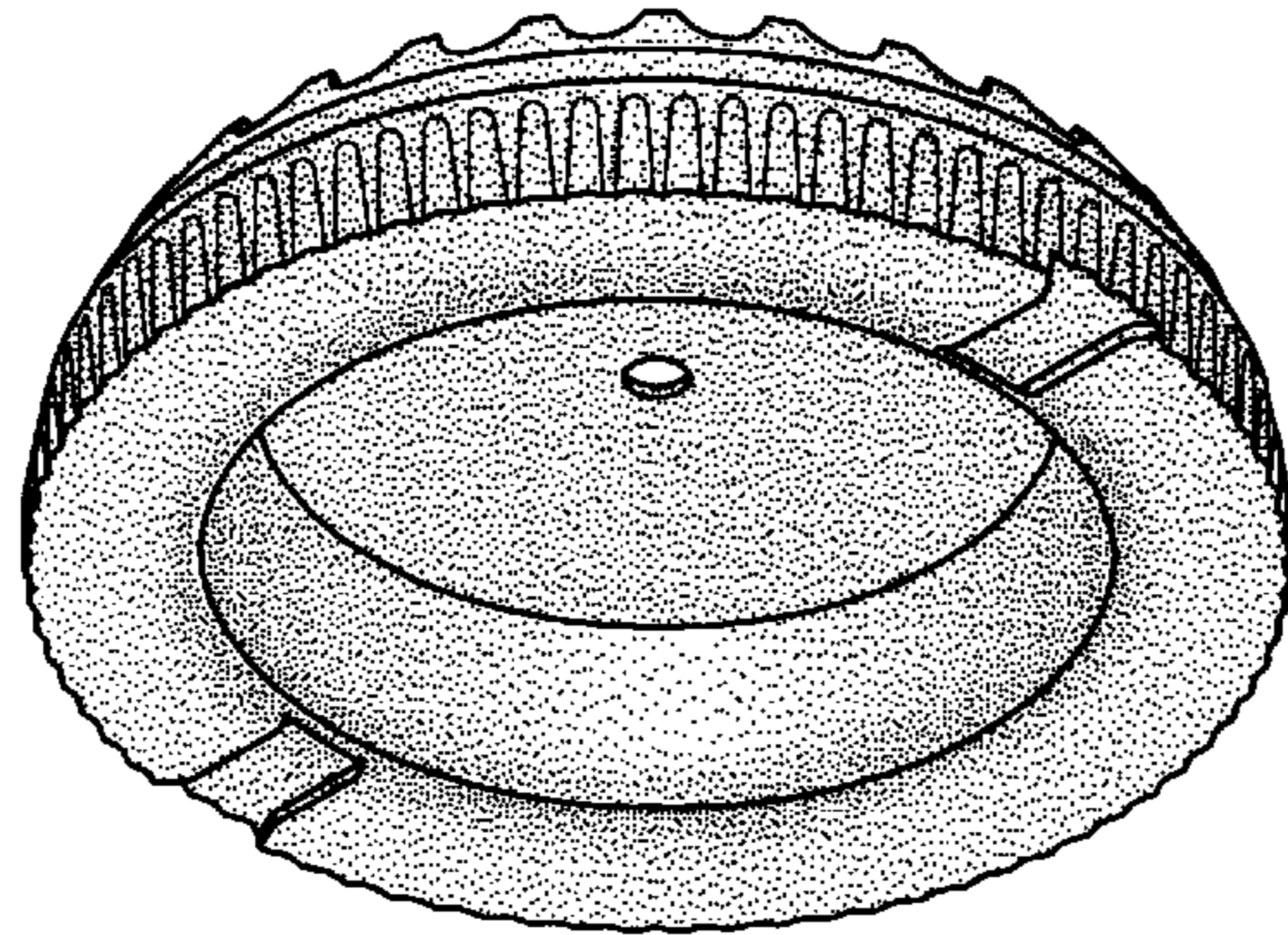

FIG. 10



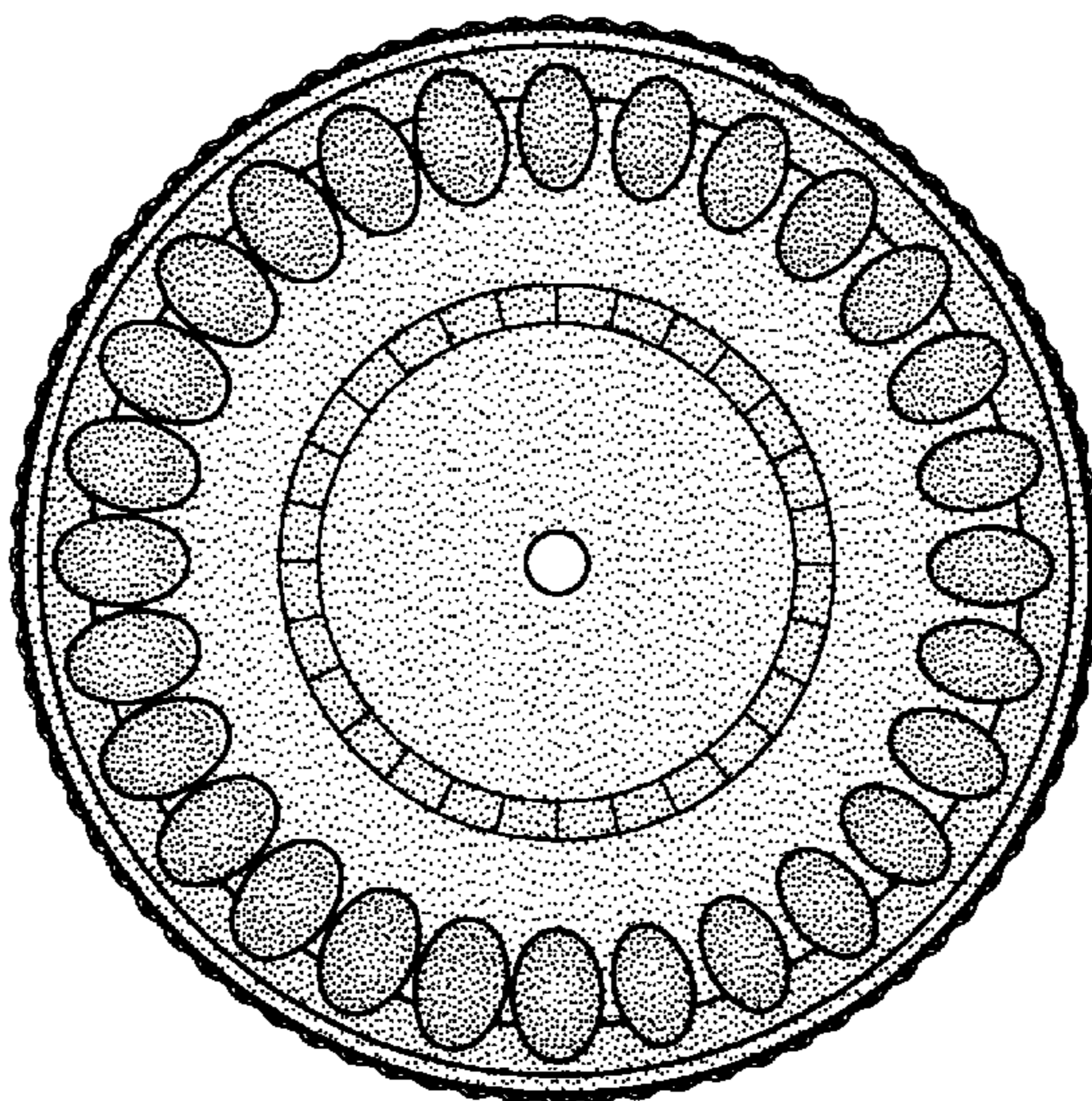

FIG. 11

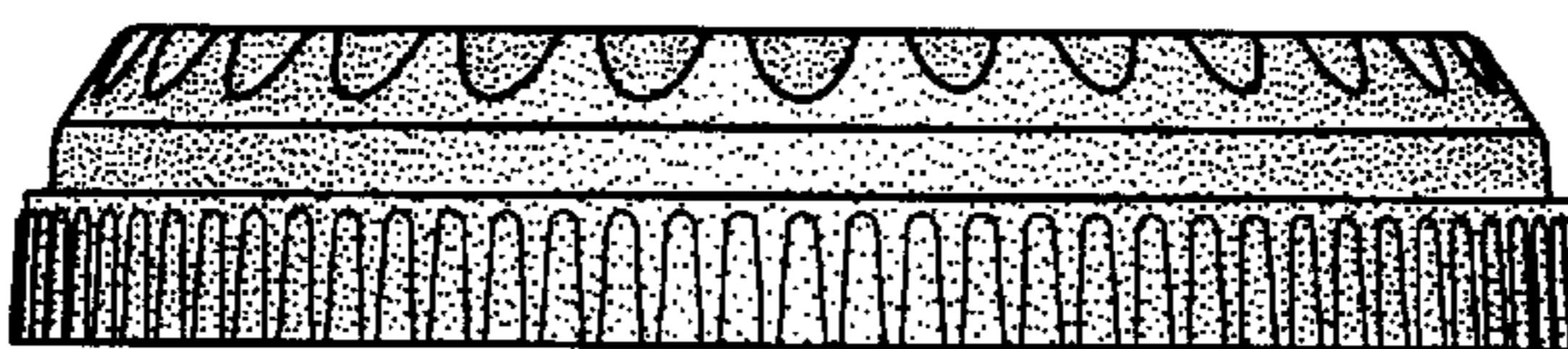

FIG. 12

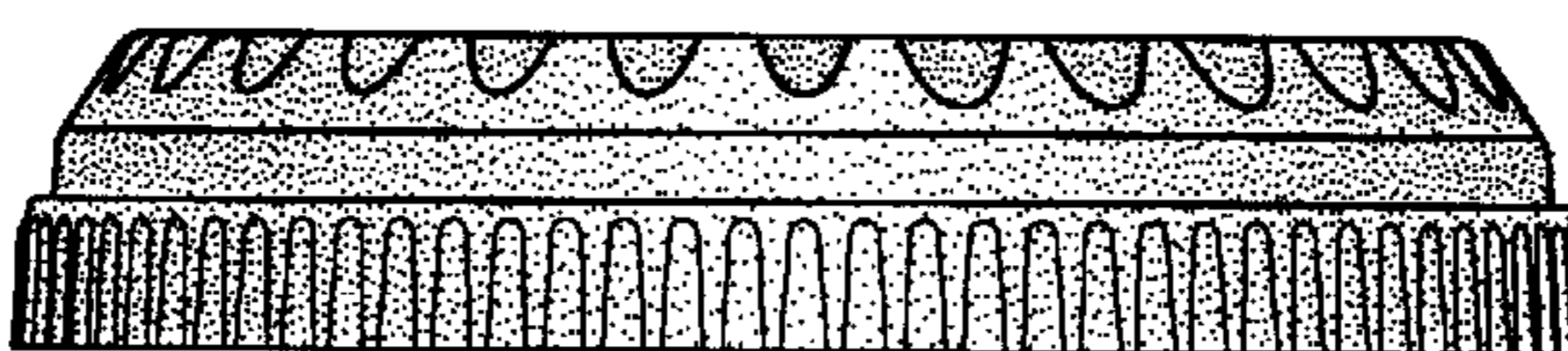

FIG. 13

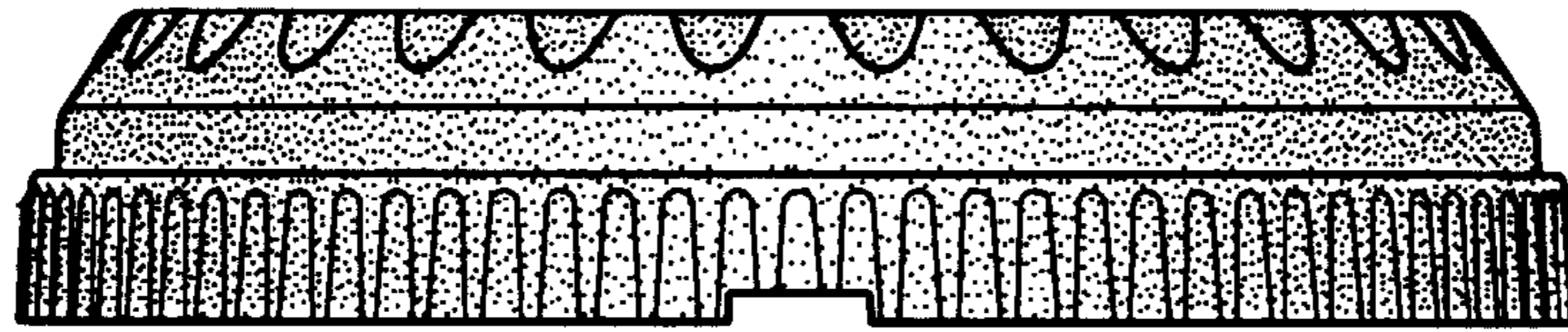
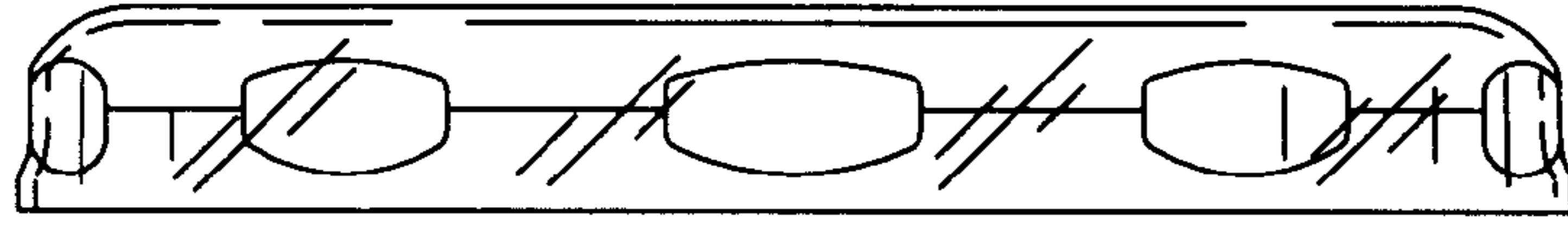

FIG. 14

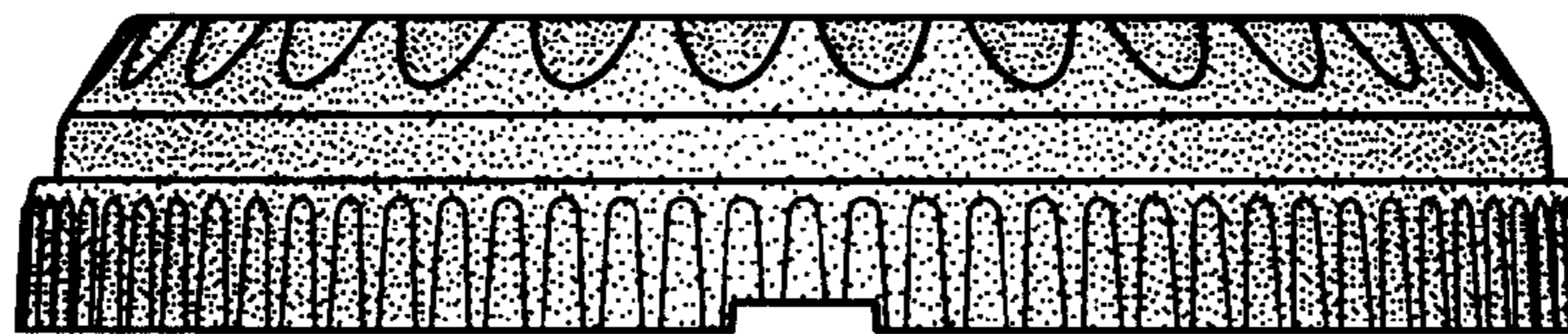
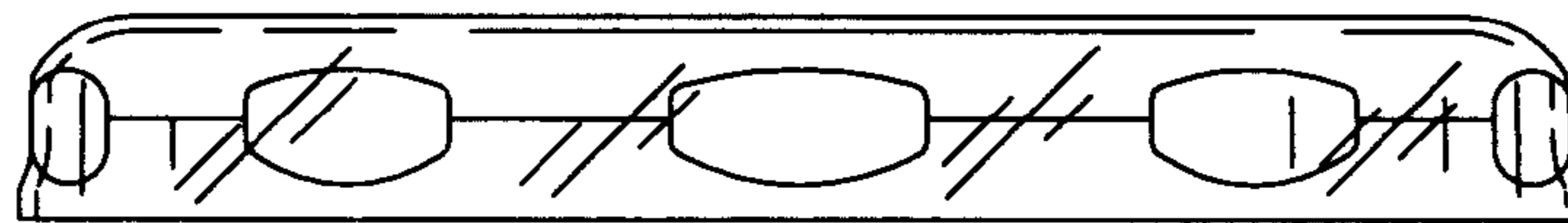

FIG. 15

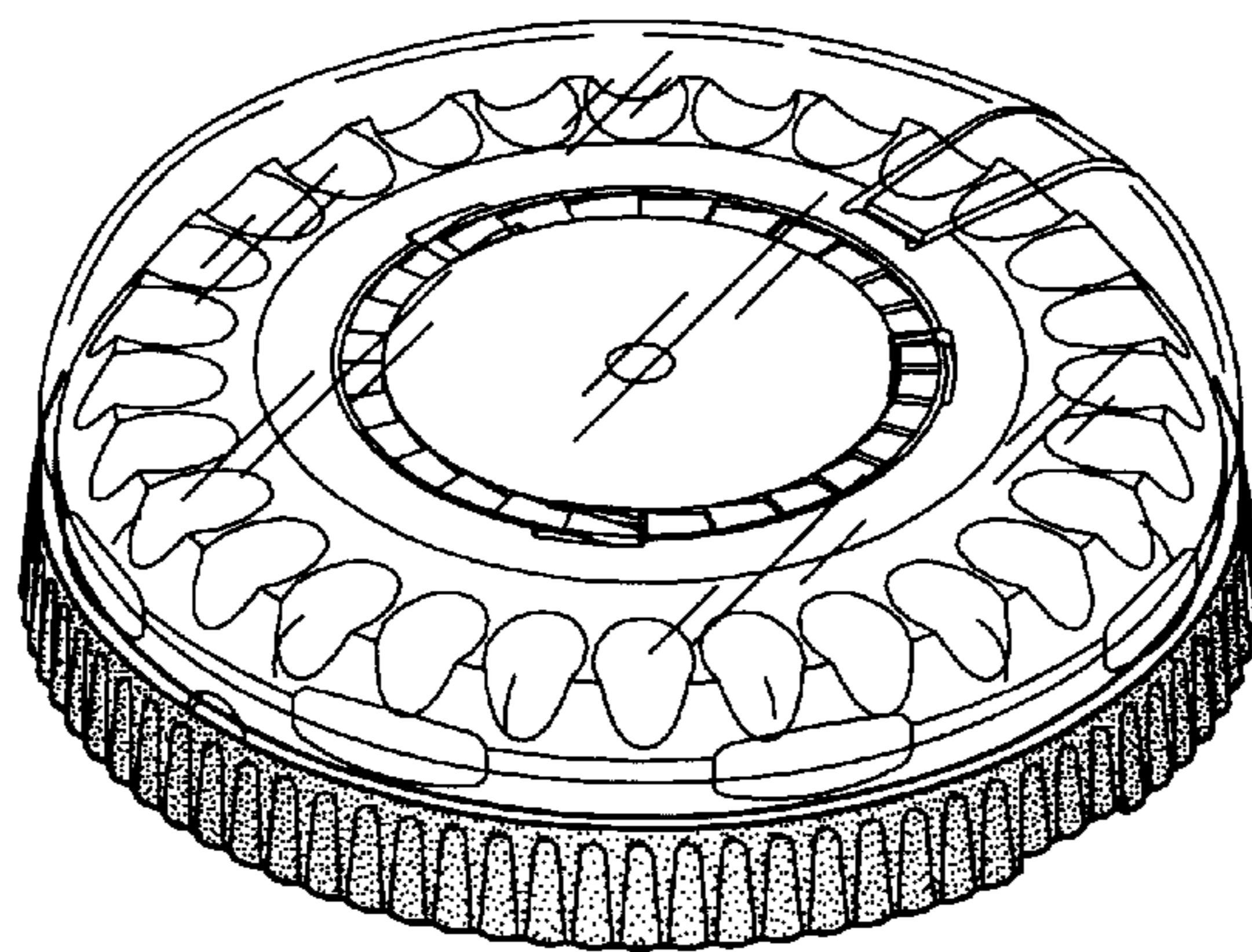
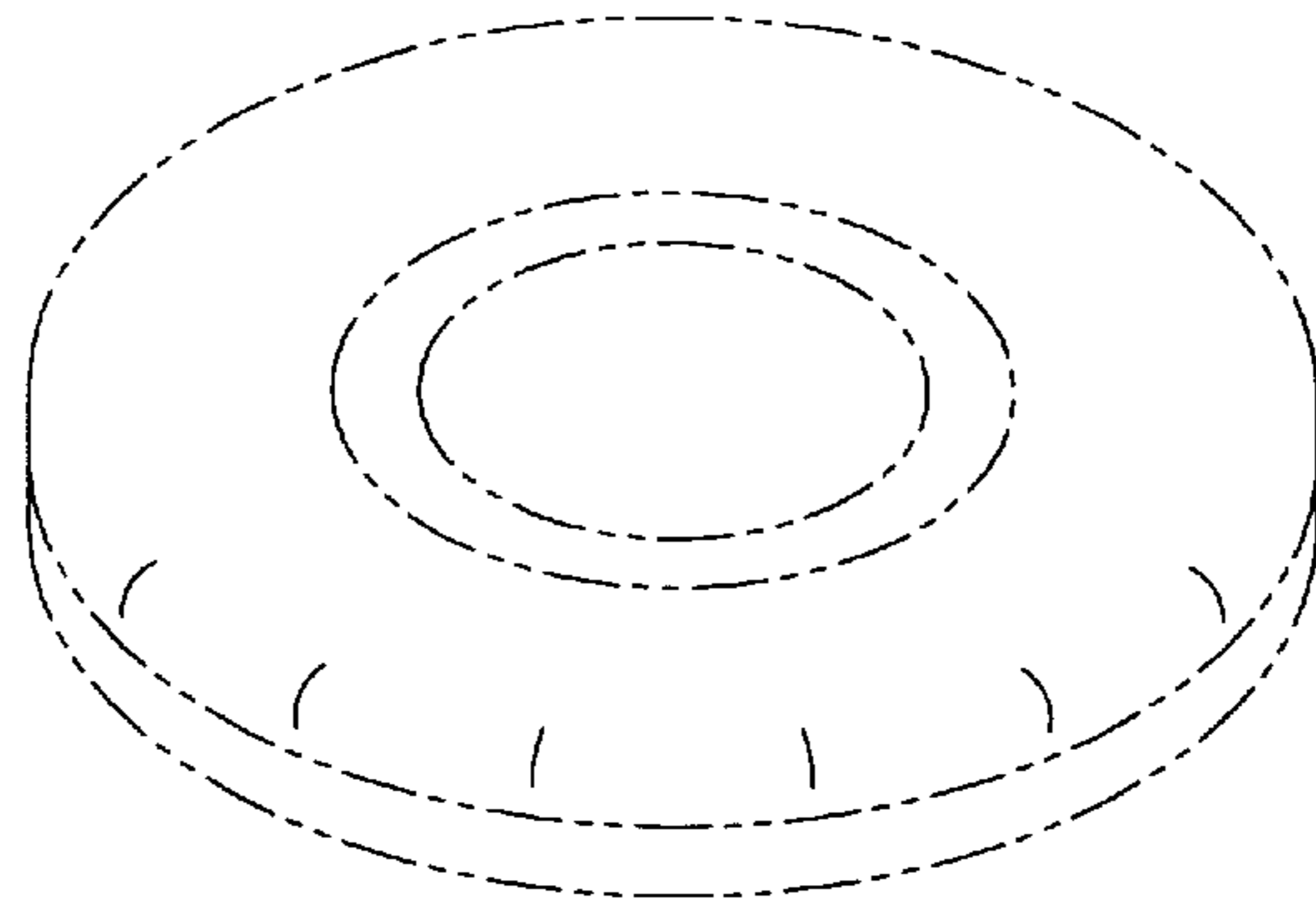

FIG. 16

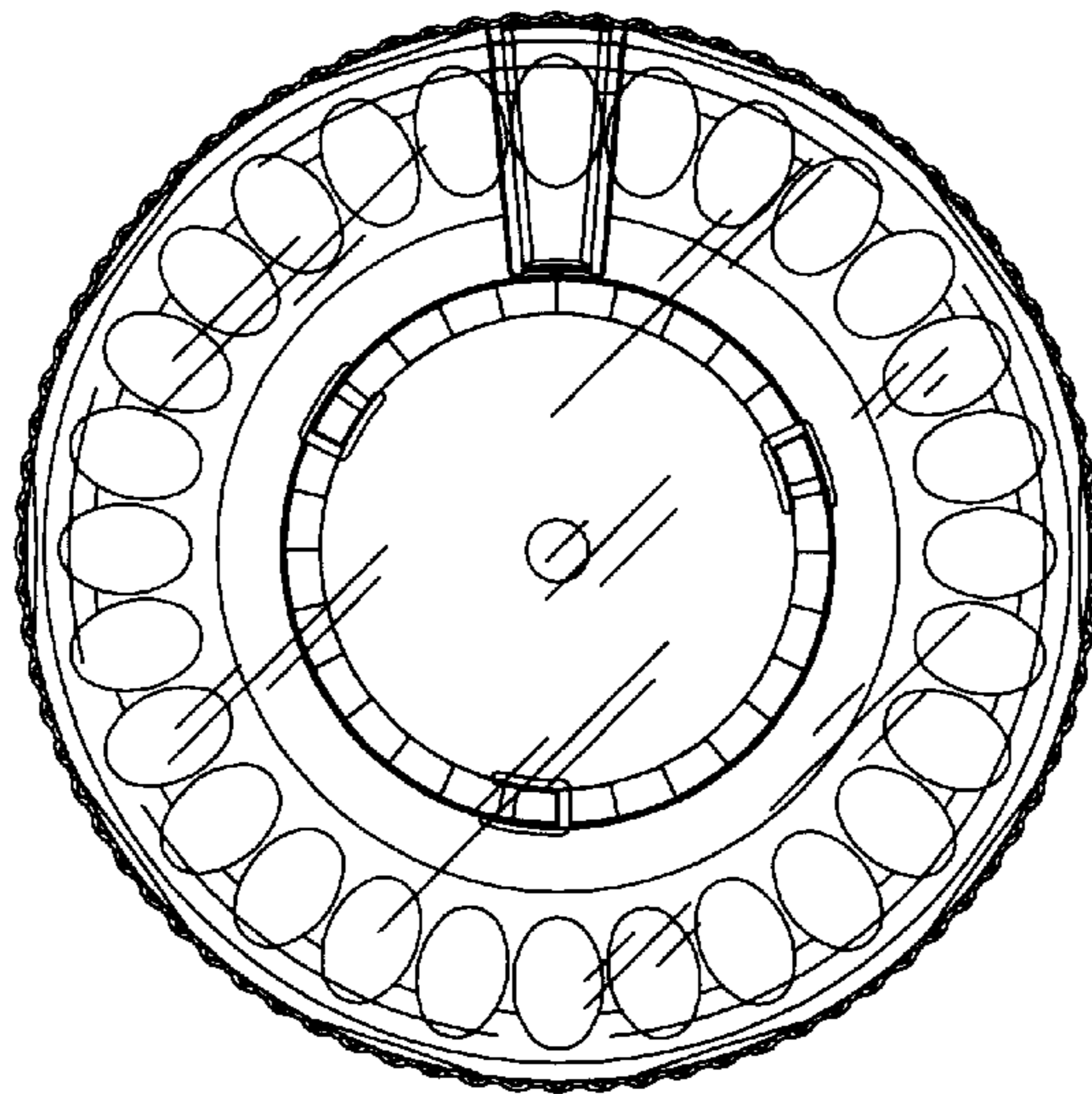

FIG. 17

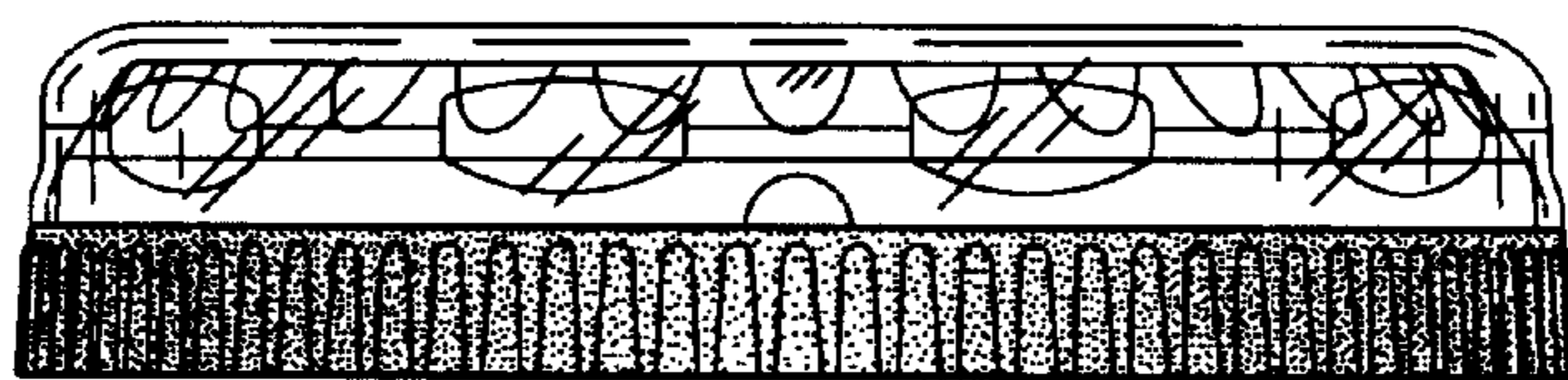

FIG. 18

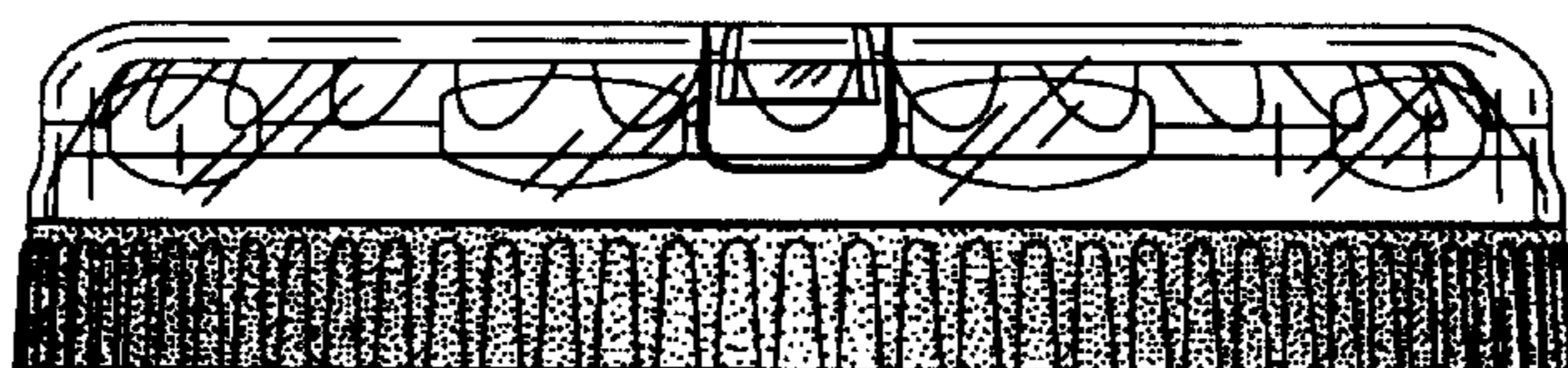

FIG. 19

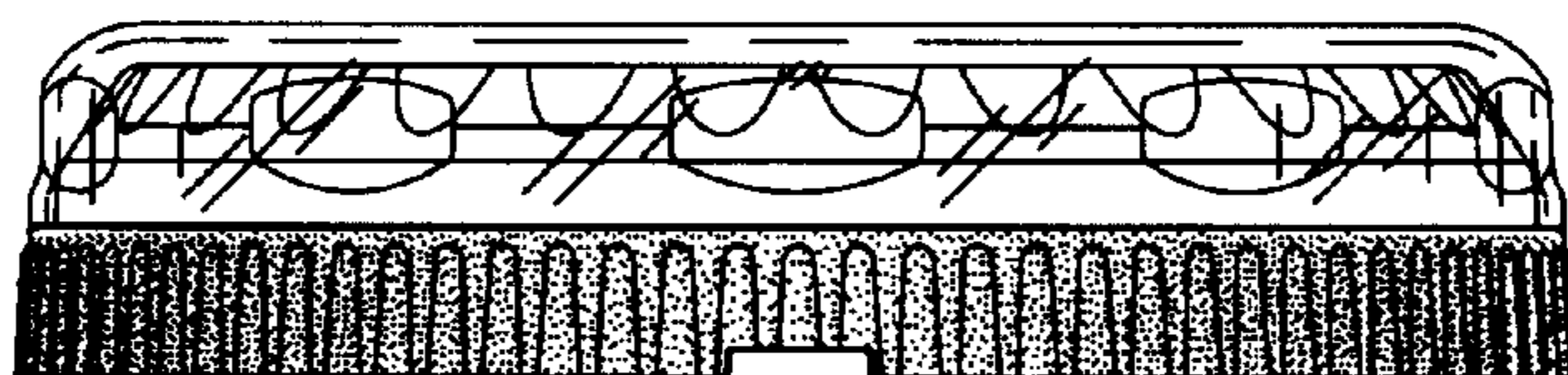

FIG. 20

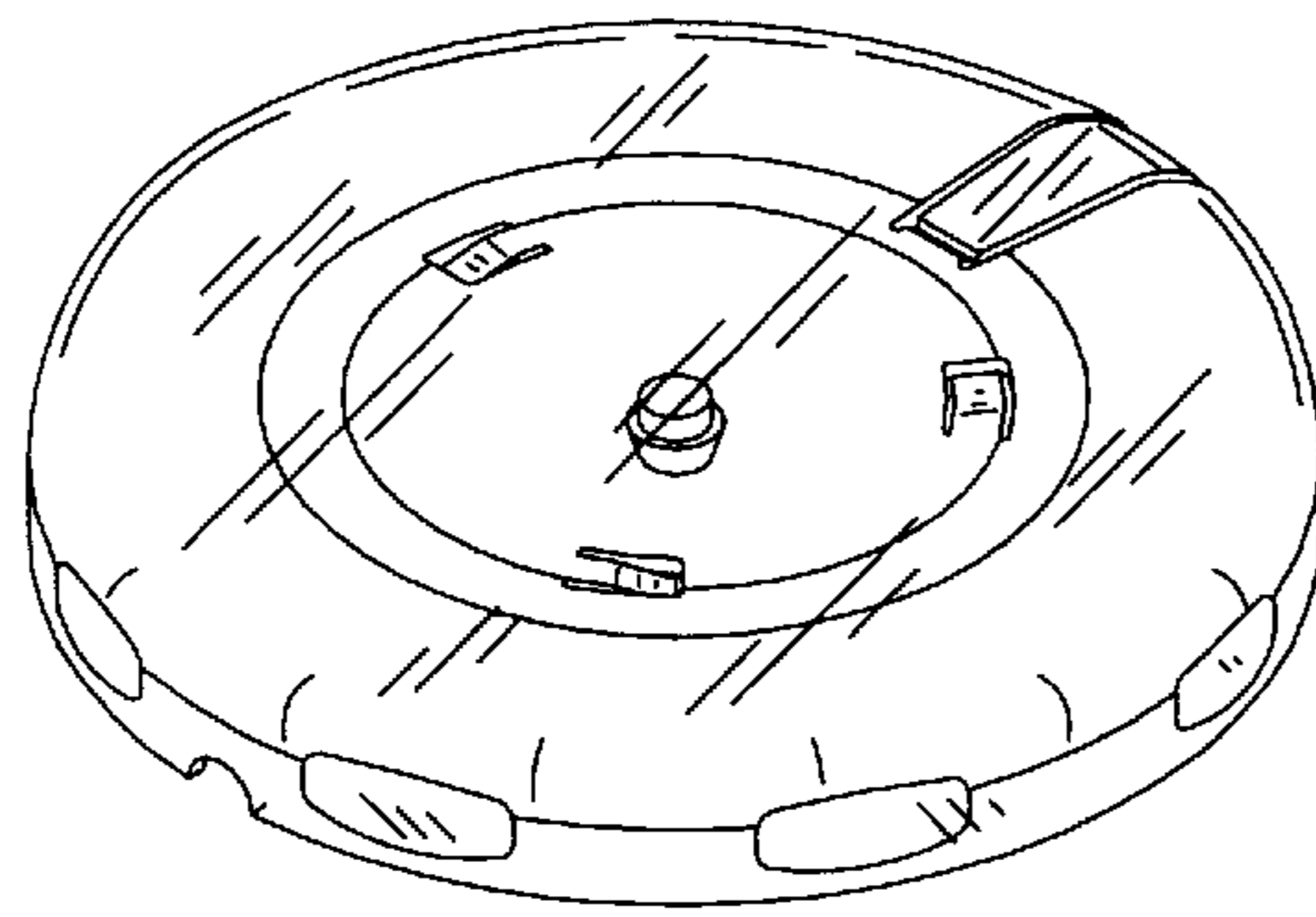

FIG. 21

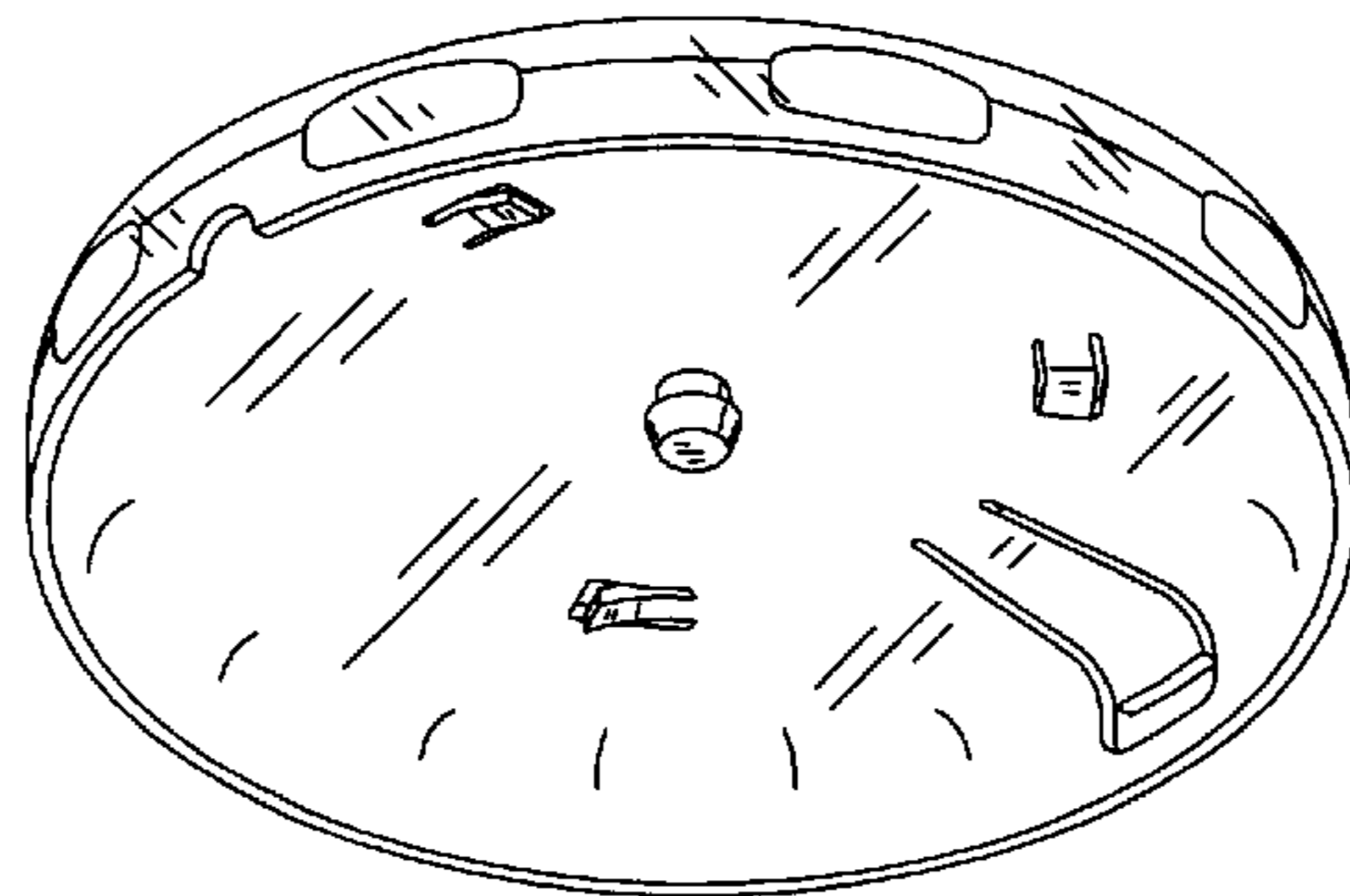
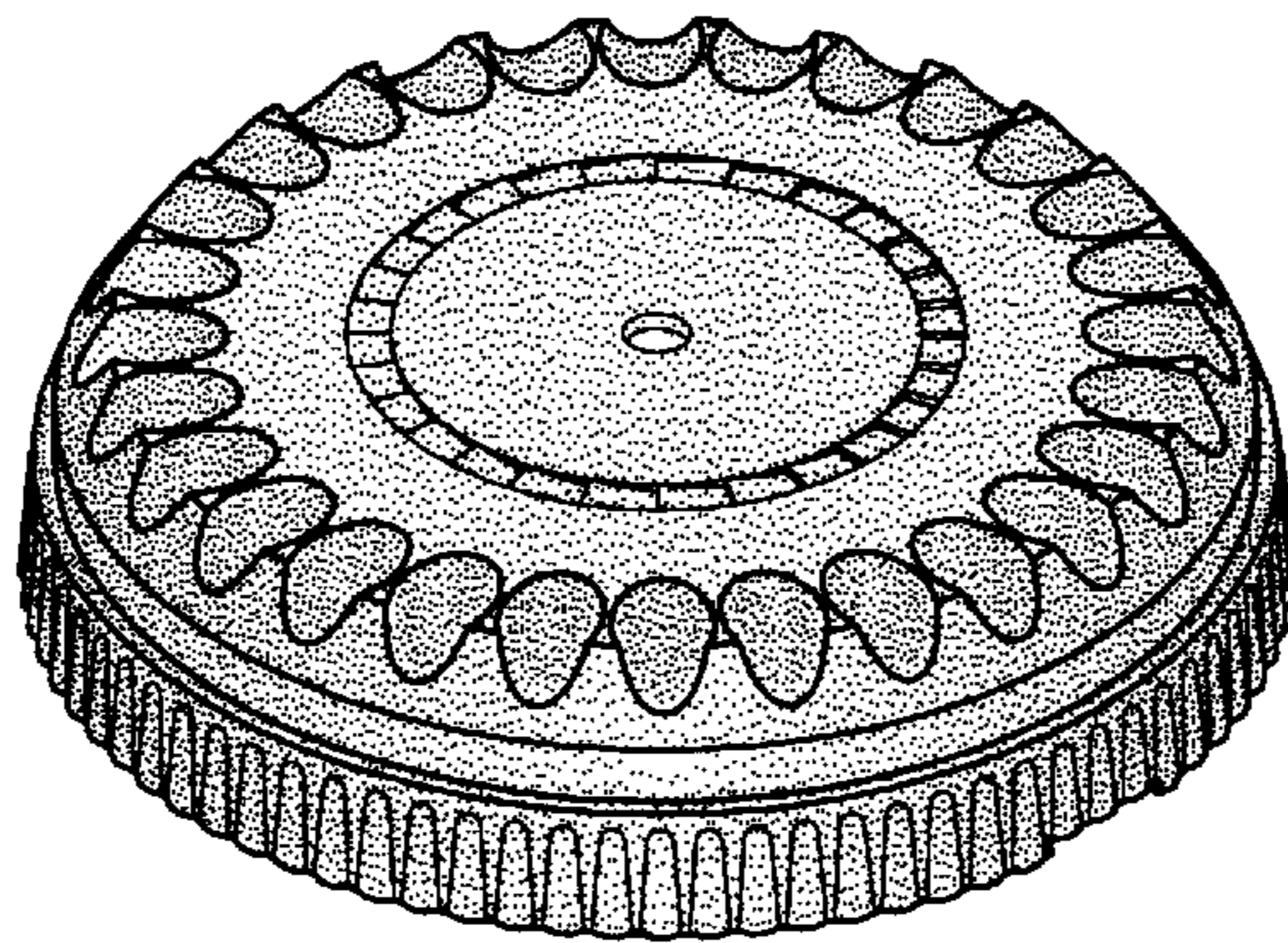
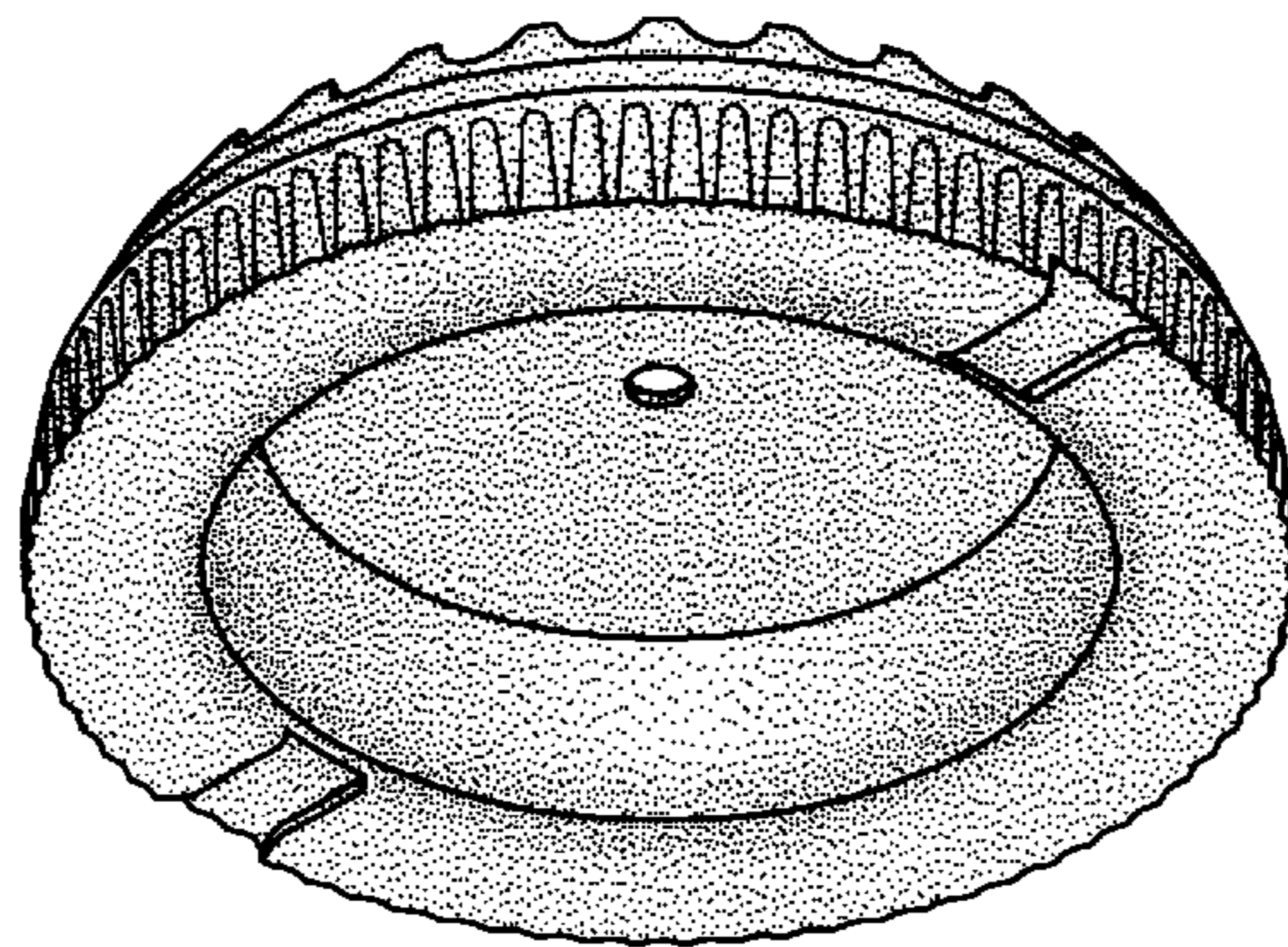

FIG. 22



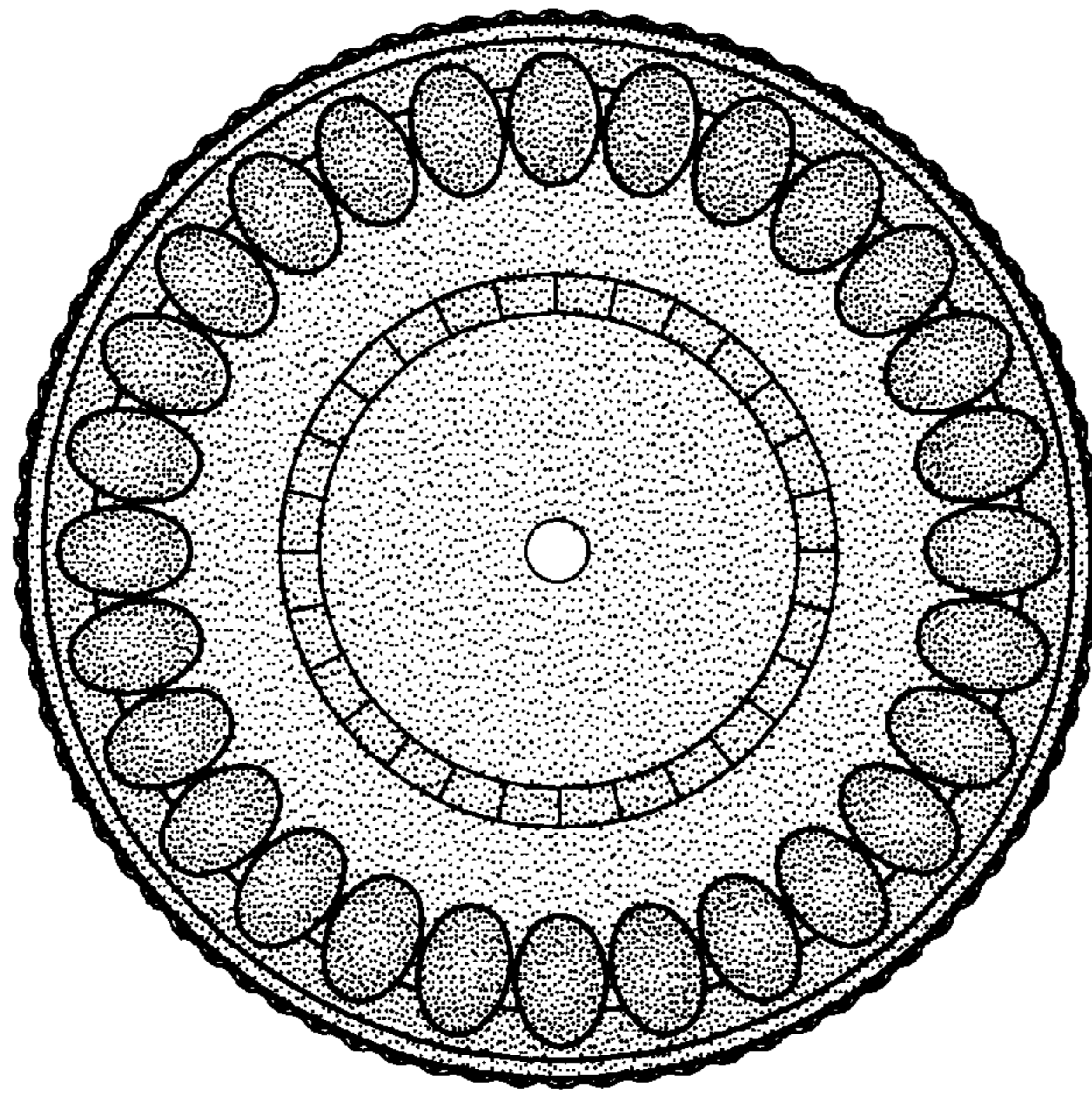

FIG. 23

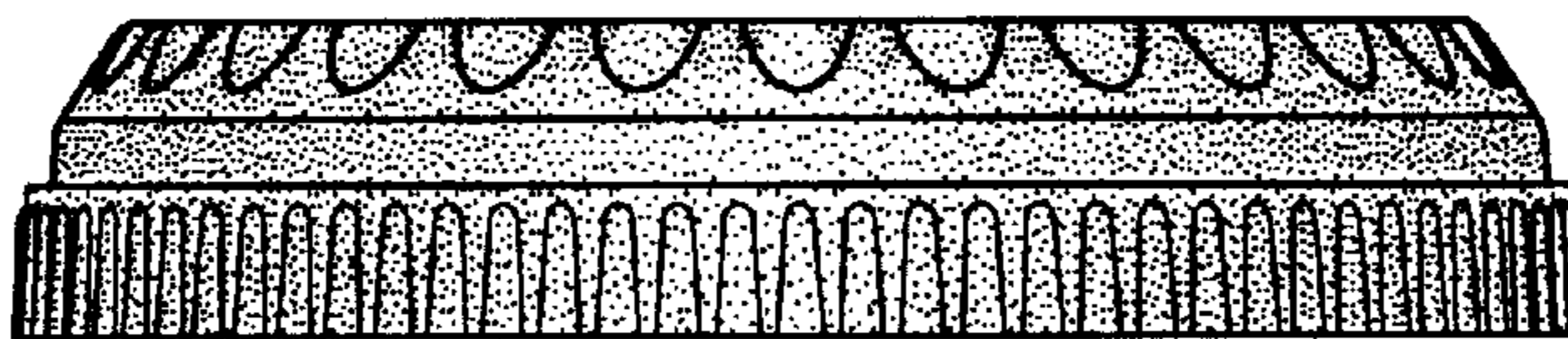

FIG. 24

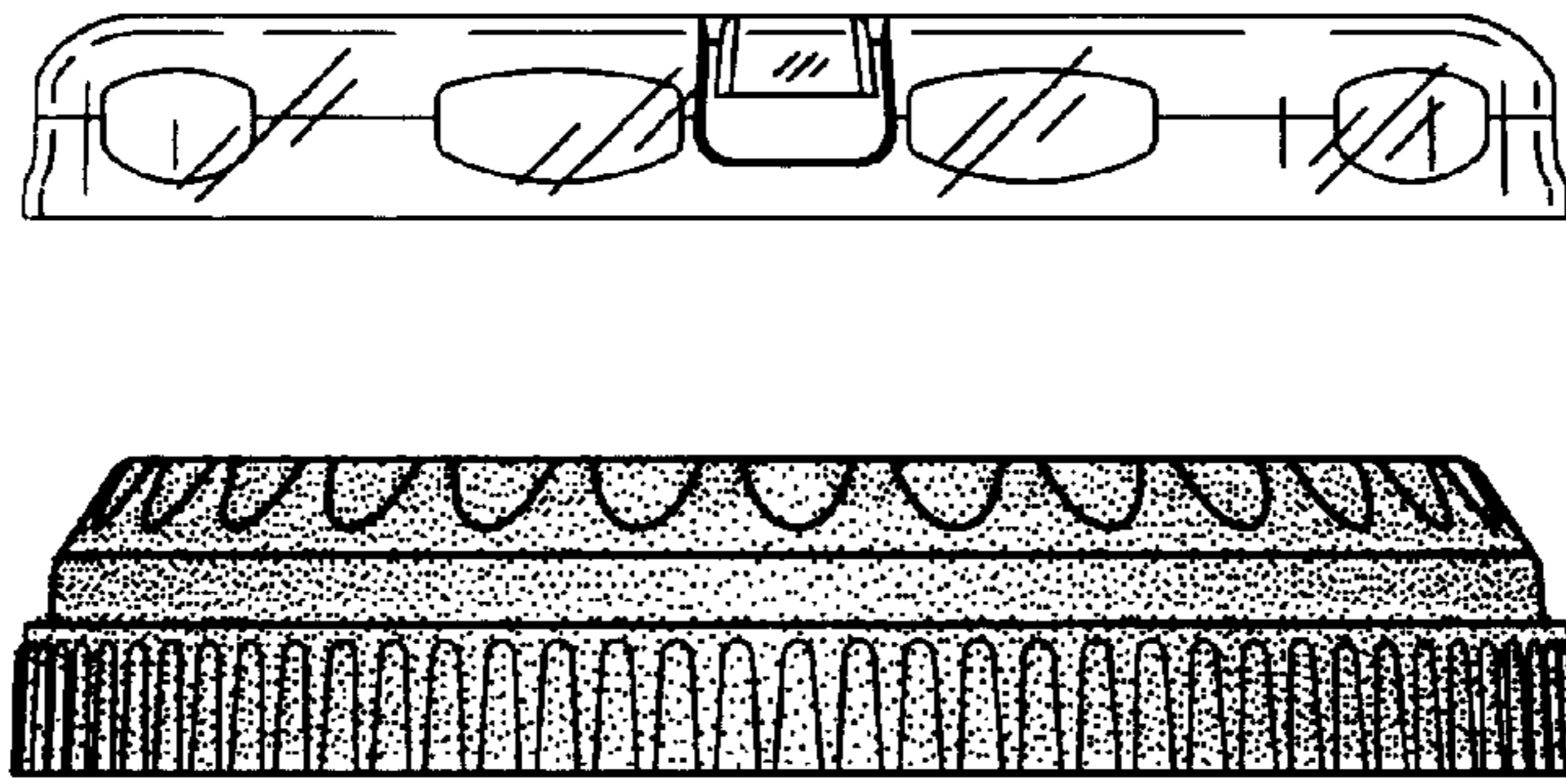

FIG. 25

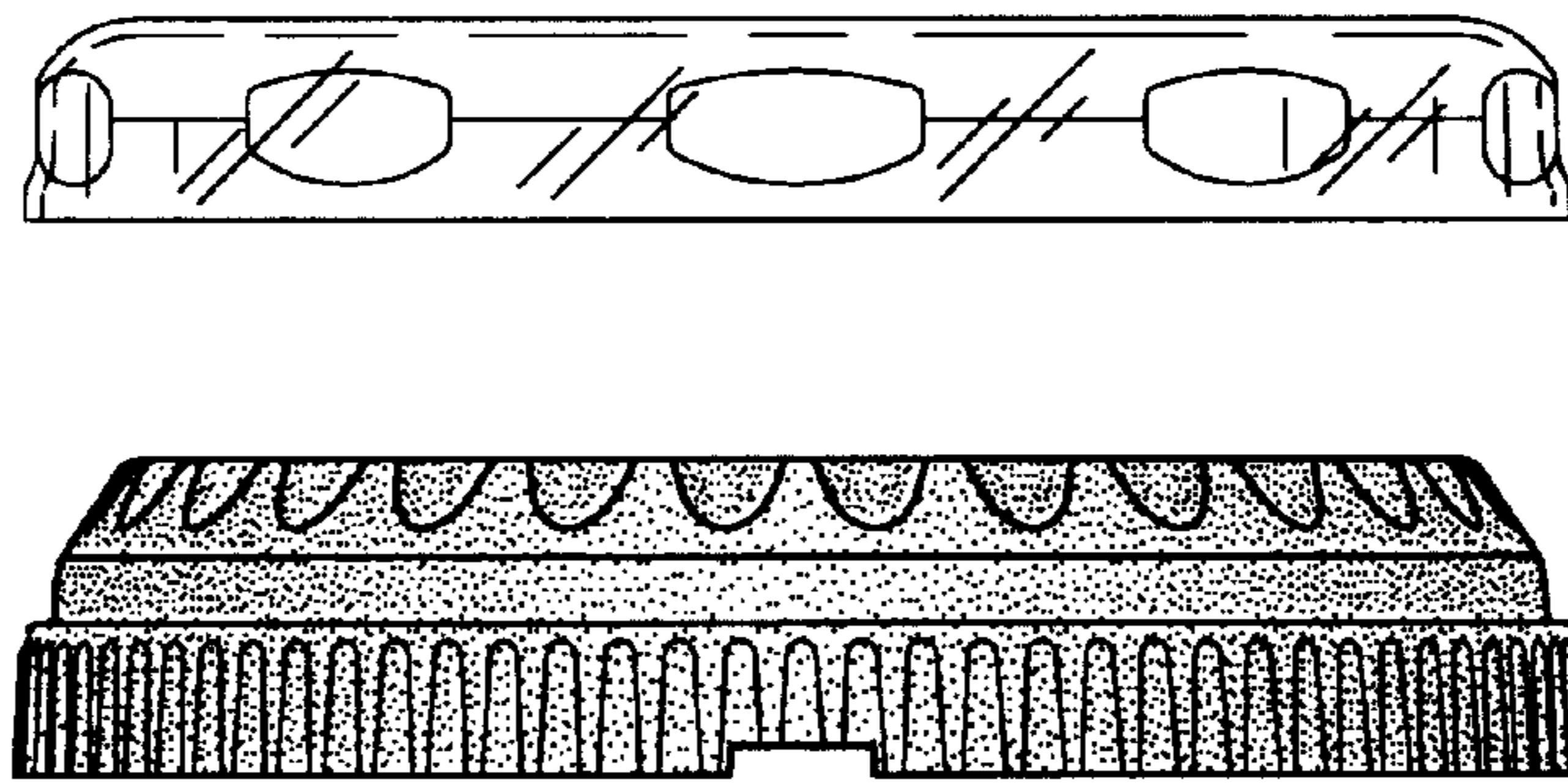

FIG. 26