



US00D423876S

United States Patent [19]

Wagner et al.

[11] Patent Number: **Des. 423,876**

[45] Date of Patent: **** May 2, 2000**

[54] **CASTING FOR BARBECUE GRILL**

[75] Inventors: **Wesley J. Wagner**, Columbus; **Sam Zaidspiner**, Lawrenceville, both of Ga.; **Ken Richied**, Dayton, Ohio

[73] Assignee: **W. C. Bradley Company**, Columbus, Ga.

[**] Term: **14 Years**

[21] Appl. No.: **29/092,294**

[22] Filed: **Aug. 14, 1998**

[51] **LOC (7) Cl.** **07-02**

[52] **U.S. Cl.** **D7/402; D7/332**

[58] **Field of Search** D7/332-338, 402-404; 126/275 R, 275 E, 19 M, 19 R, 21 A, 25 R, 25 A, 25 AA, 29-30, 9 R, 9 A, 9 B, 39 R, 41 R, 40; 219/10.55 R, 10.55 A, 10.55 B, 10.55 C, 403, 386; 99/340-341, 419, 421 R, 421 H, 446, 450

[56] **References Cited**

U.S. PATENT DOCUMENTS

D. 287,214 12/1986 Koziol D7/332

D. 287,215 12/1986 Koziol D7/332
D. 373,701 9/1996 Moore D7/334
D. 406,005 2/1999 Wagner et al. D7/335
D. 406,009 2/1999 Wagner et al. D7/402
D. 406,489 3/1999 Williams et al. D7/334
5,927,267 7/1999 McKenzie 126/41 R

Primary Examiner—Ruth McInroy
Attorney, Agent, or Firm—James W. Kayden, Esq.; Thomas, Kayden, Horstemeyer & Risley

[57] **CLAIM**

The ornamental design of a casting for barbecue grill, as shown and described.

DESCRIPTION

FIG. 1 is a perspective view of a casting for a barbecue grill showing our new design;
FIG. 2 is a front elevational view thereof;
FIG. 3 is a right side elevational view thereof;
FIG. 4 is a left side elevational view thereof;
FIG. 5 is a rear elevational view thereof;
FIG. 6 is a top plan view thereof; and,
FIG. 7 is a bottom plan view thereof.

1 Claim, 4 Drawing Sheets

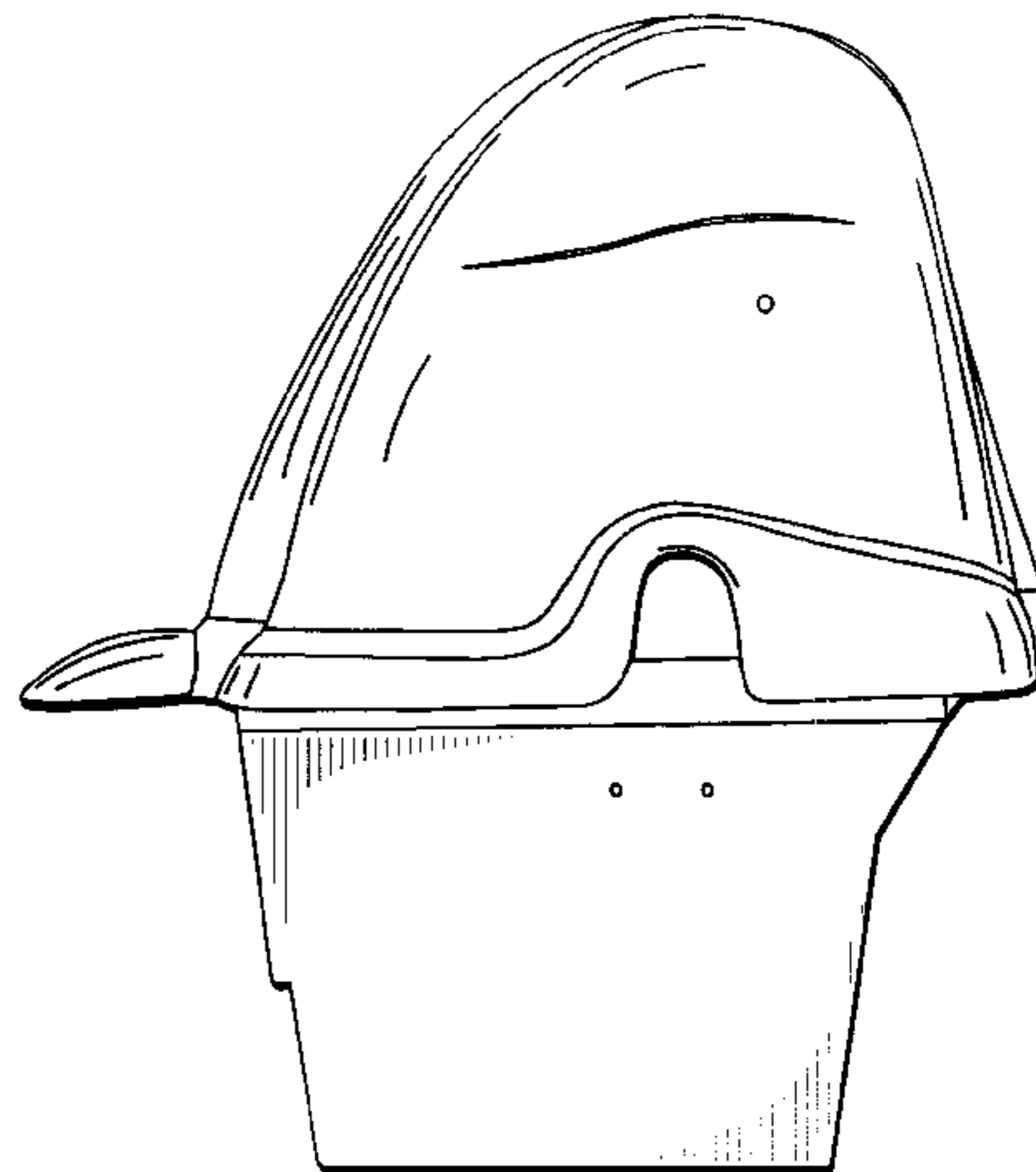
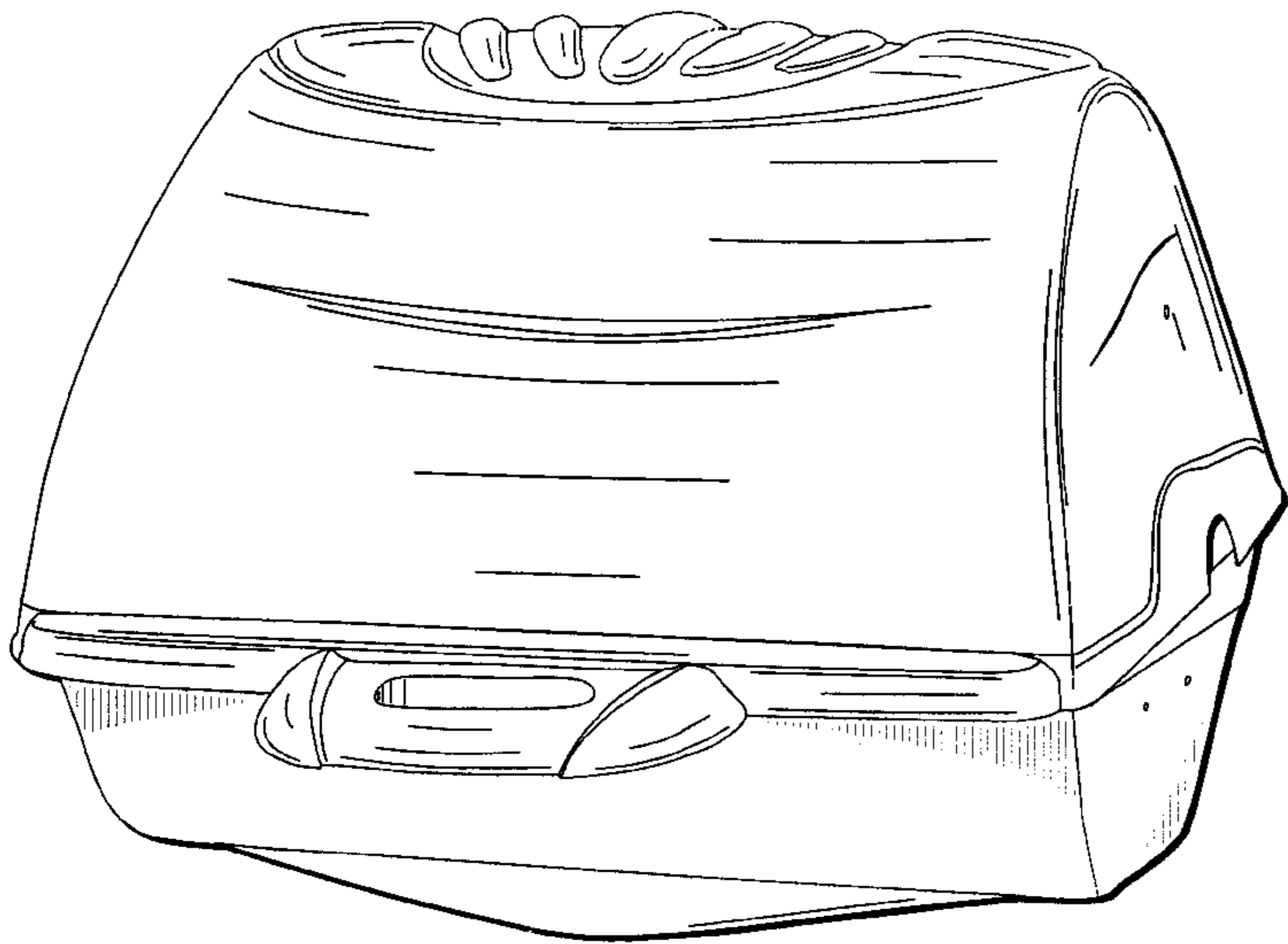

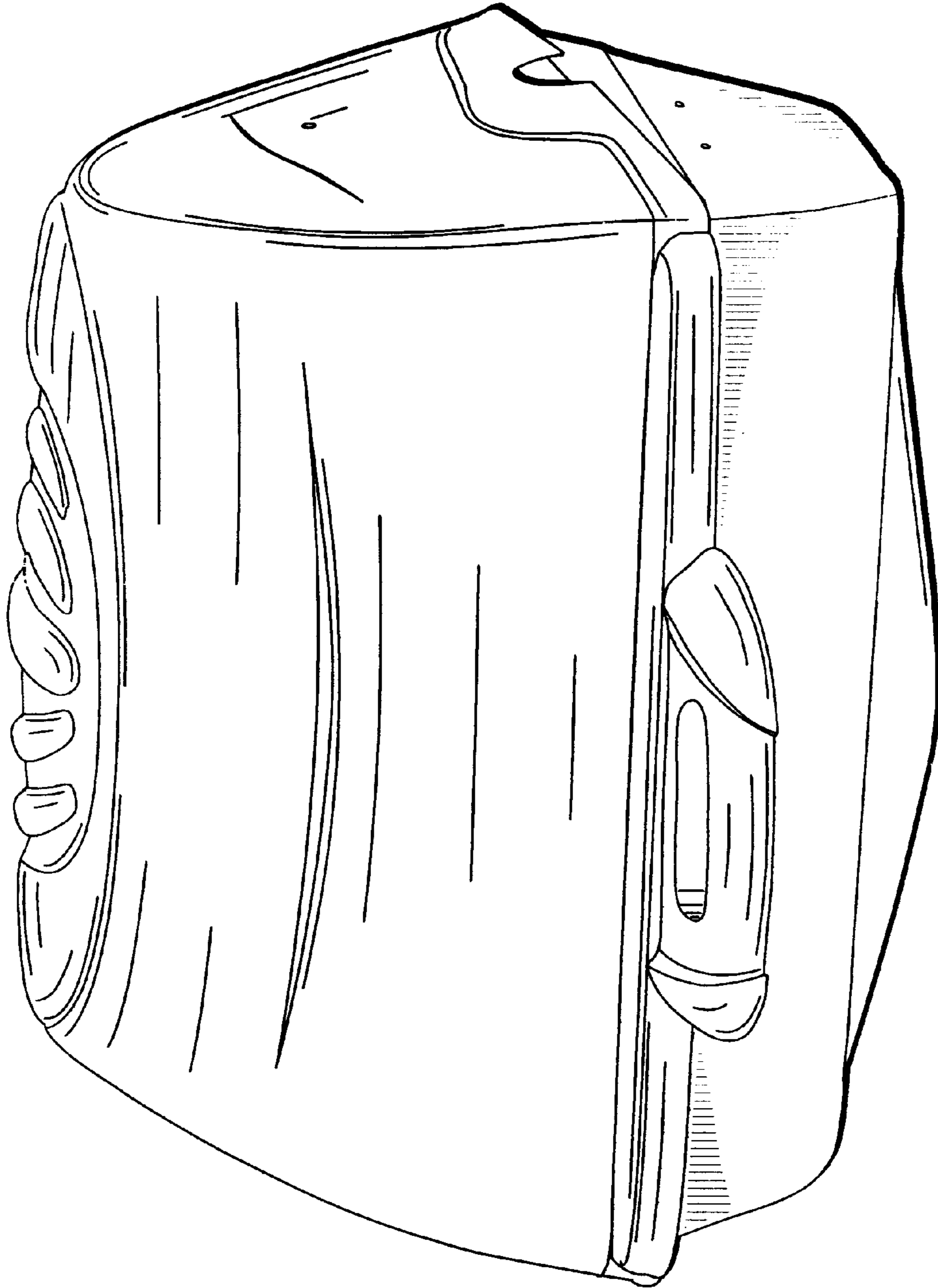

FIG. 1

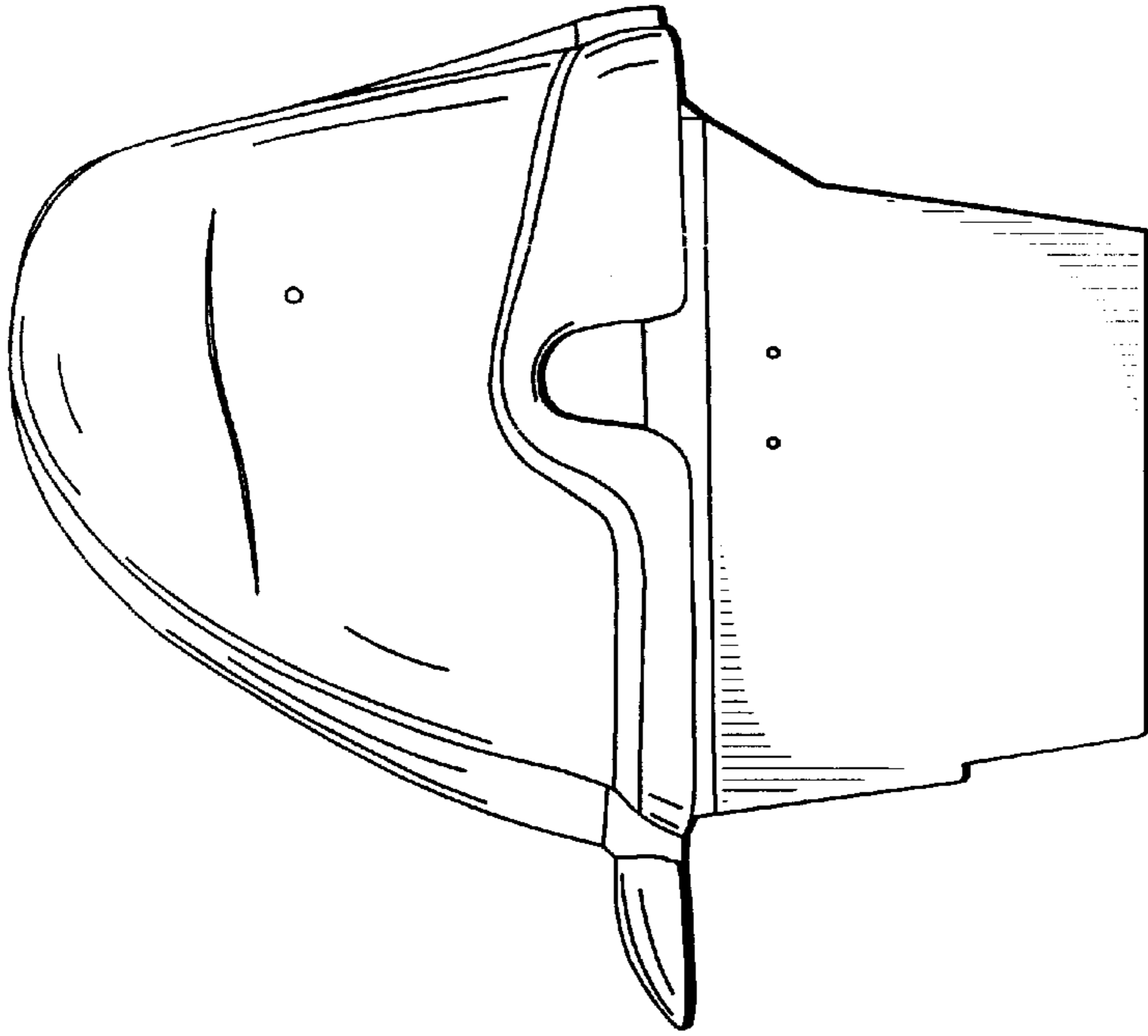

FIG. 3

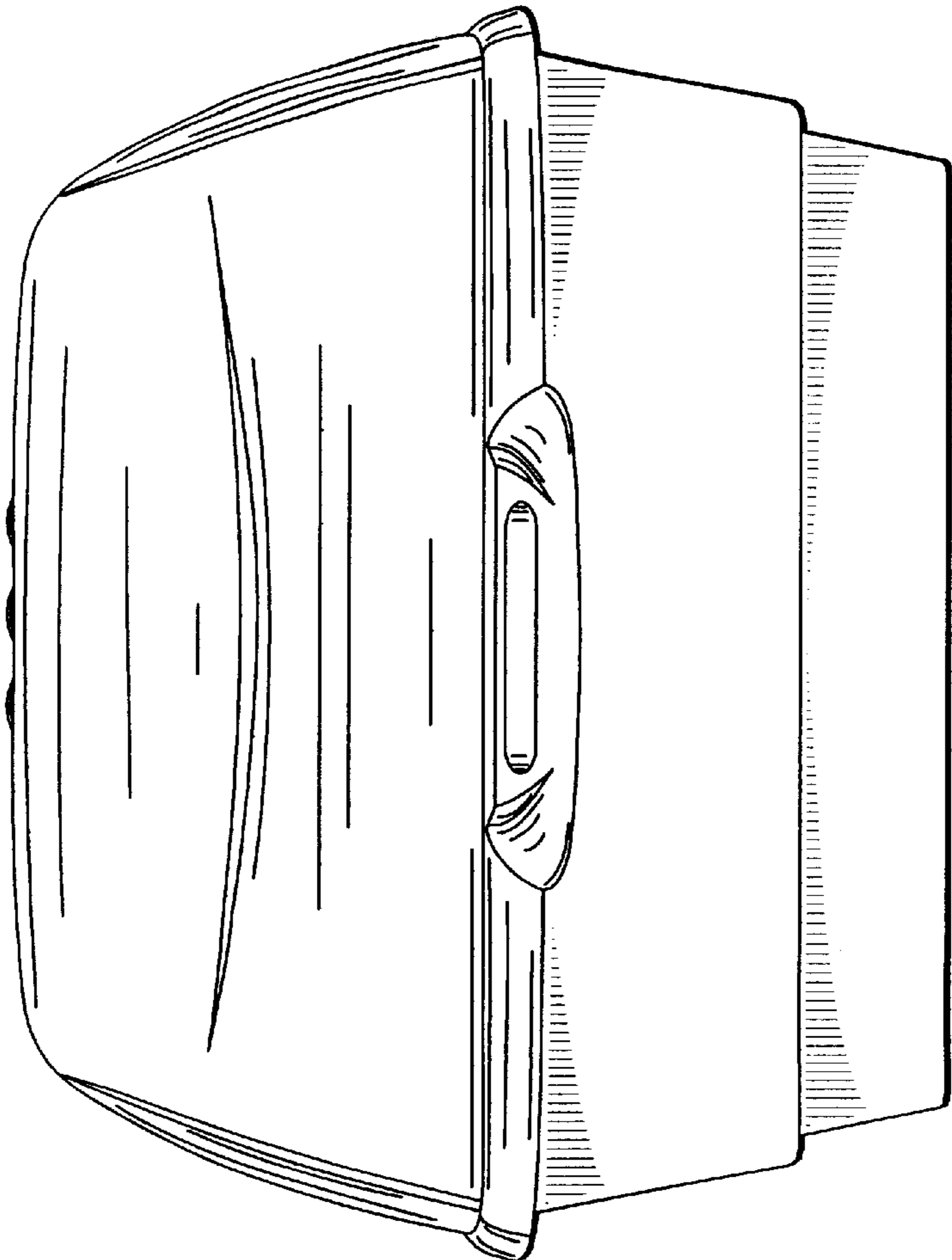

FIG. 2

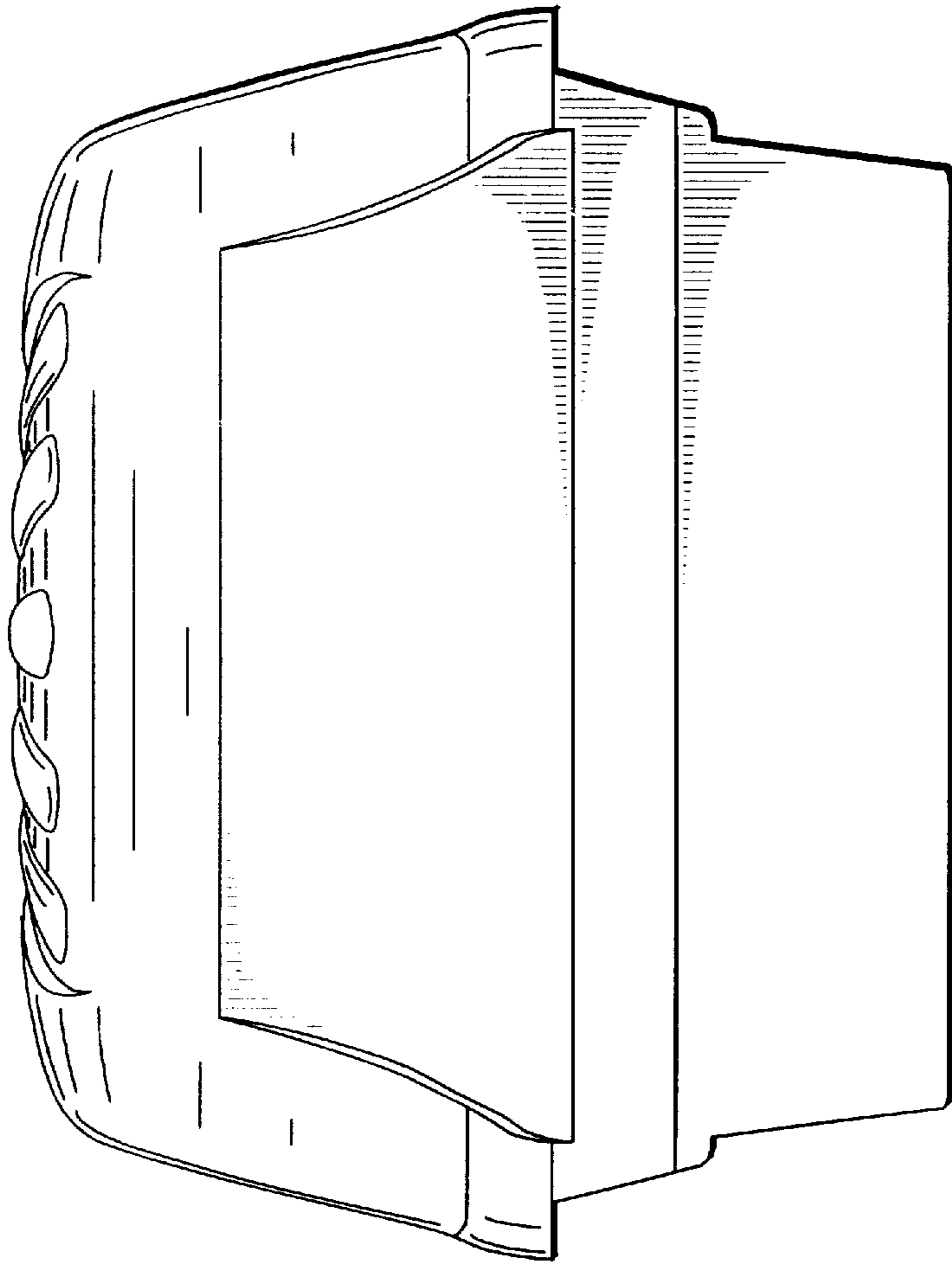

FIG. 5

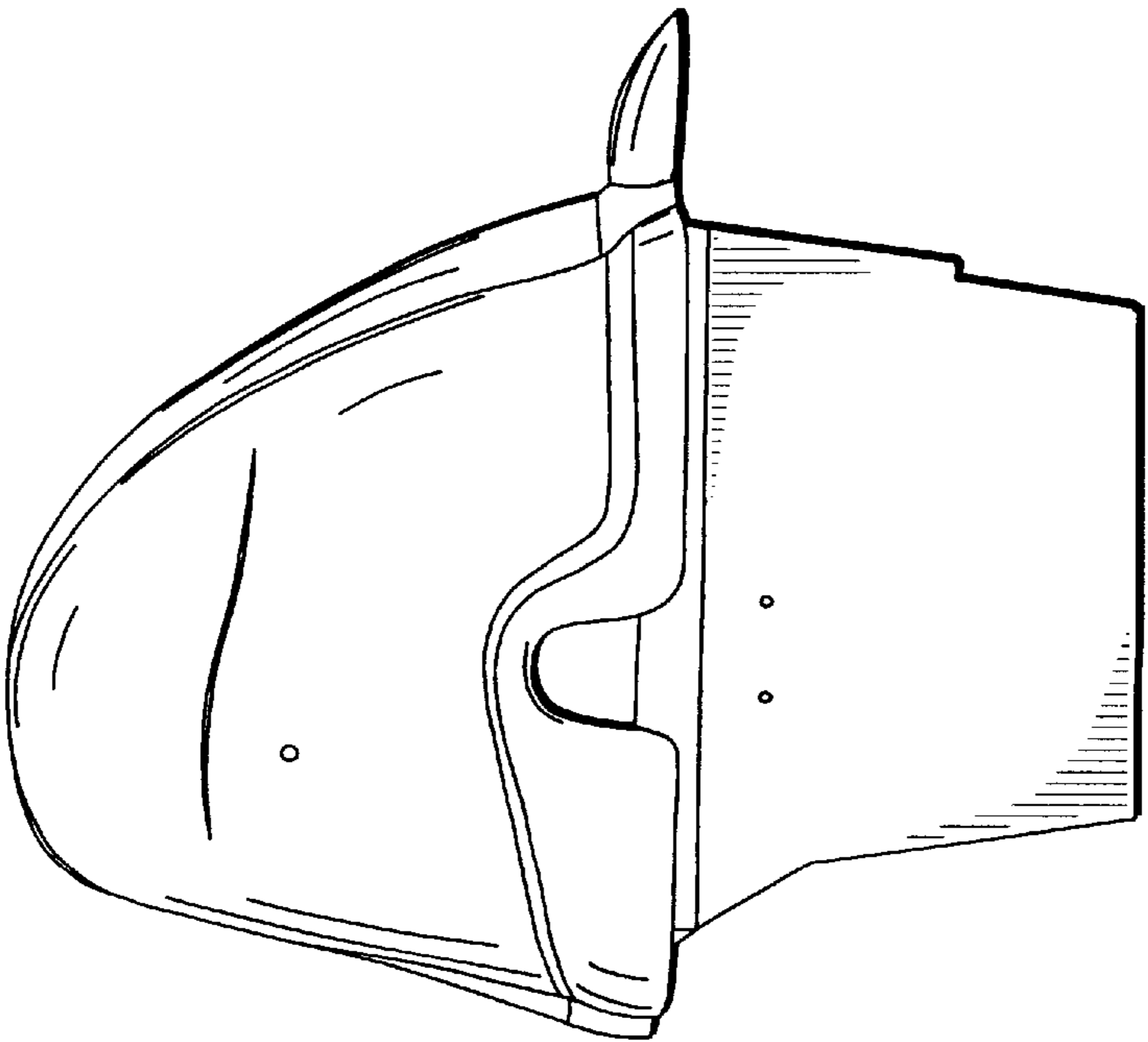

FIG. 4

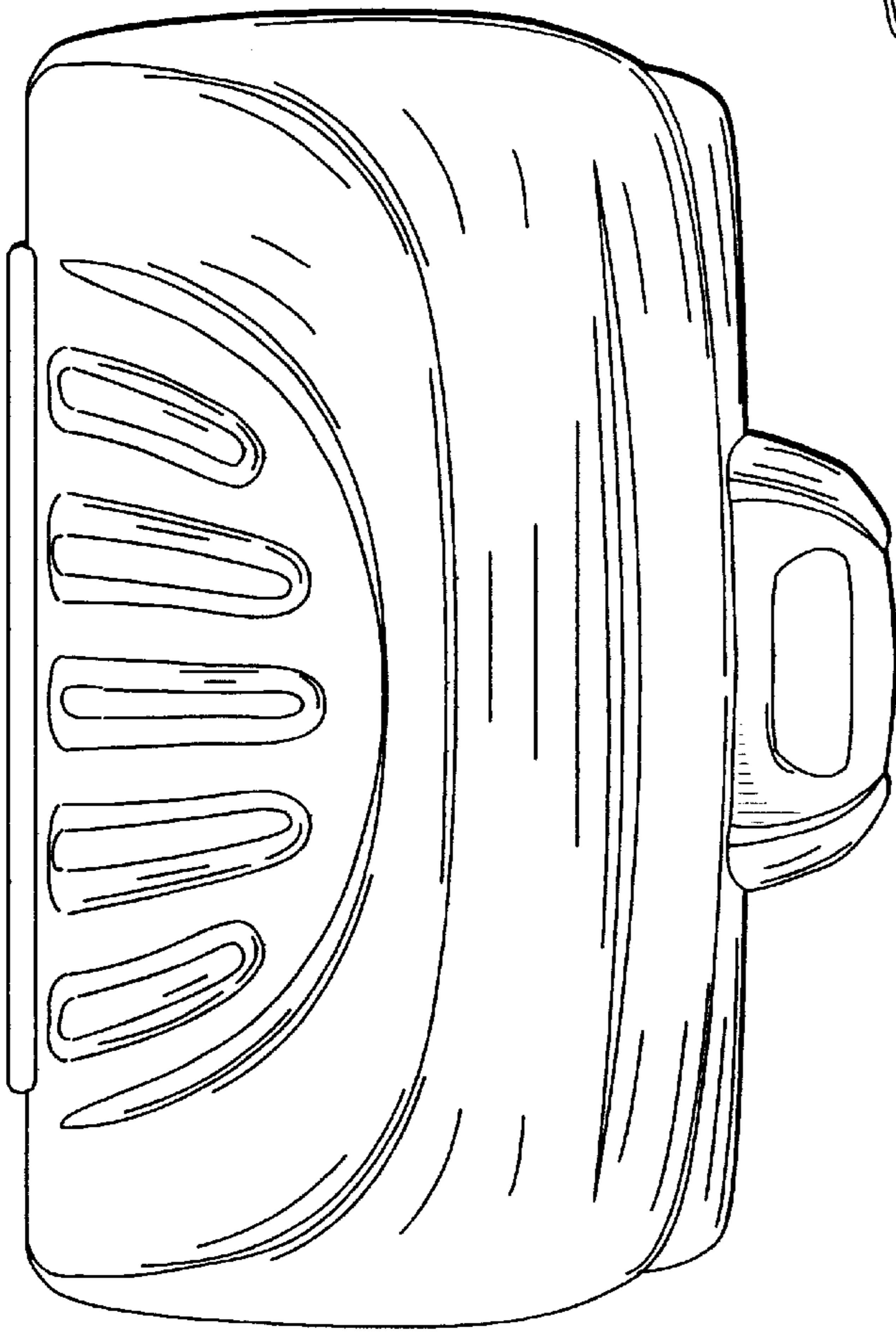

FIG. 6

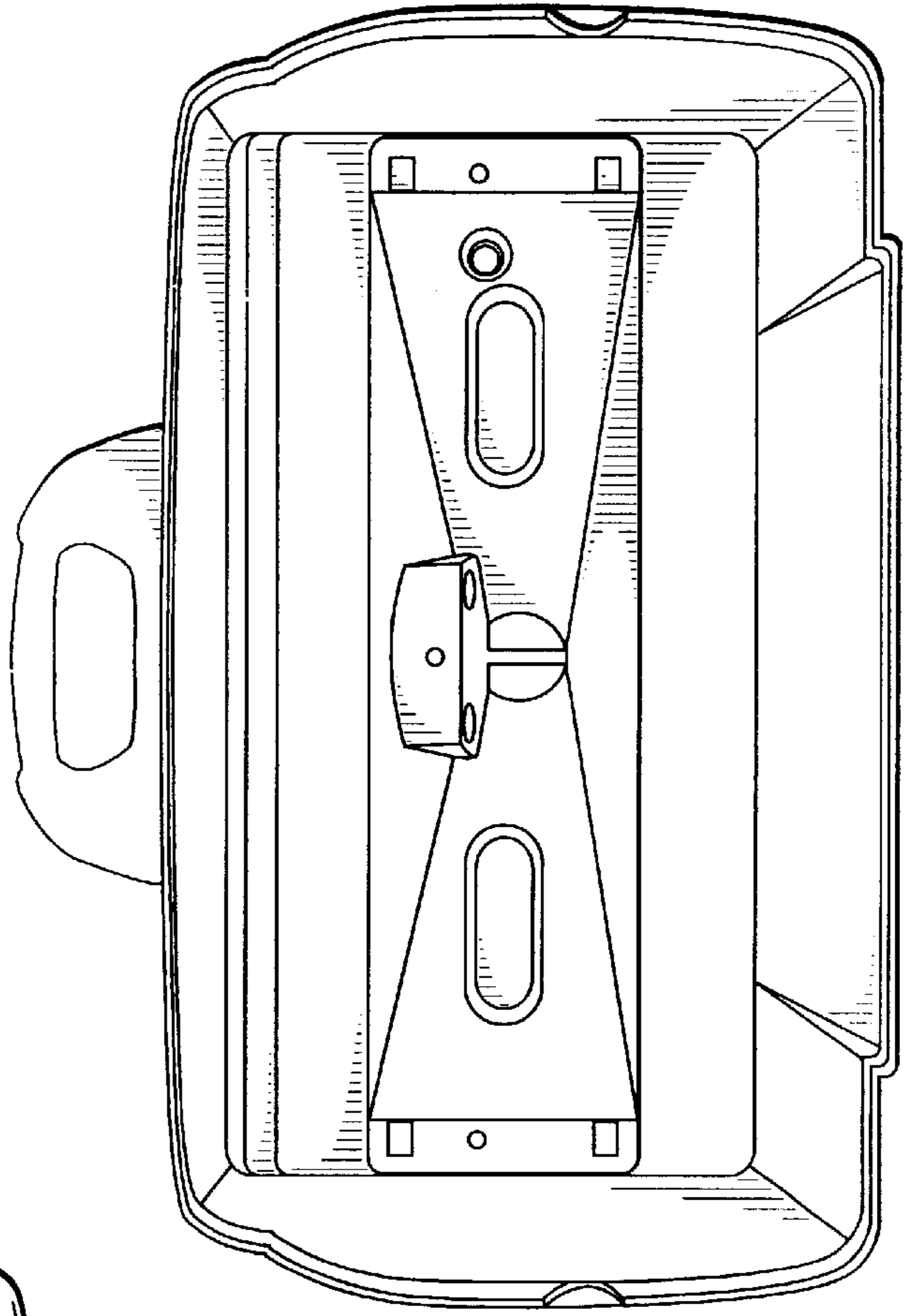

FIG. 7