



US00D423845S

**United States Patent** [19]  
**Coffin et al.**

[11] **Patent Number: Des. 423,845**

[45] **Date of Patent: \*\* May 2, 2000**

[54] **RAZOR HOLDER**

D. 370,375 6/1996 Murgida et al. .... D6/526

[75] Inventors: **David Coffin**, Milford; **Bryan P. deBlois**, Guilford, both of Conn.; **Kenneth Grange**, Hampstead; **Gavin Thomson**, London, both of United Kingdom

*Primary Examiner*—Brian N. Vinson  
*Attorney, Agent, or Firm*—Charles W. Almer

[73] Assignee: **Warner-Lambert Company**, Morris Plains, N.J.

[57] **CLAIM**

The ornamental design for a razor holder, as shown and described.

[\*\*] Term: **14 Years**

**DESCRIPTION**

[21] Appl. No.: **29/098,131**

FIG. 1 is a front perspective view of the razor holder; FIG. 2 is a top view of the razor holder; FIG. 3 is a bottom view of the razor holder; FIG. 4 is a front view of the razor holder; FIG. 5 is a right side view of the razor holder; FIG. 6 is a left side view of the razor holder; FIG. 7 is a back view of the razor holder; FIG. 8 is a front perspective view of the razor holder shown with a razor cartridge dispenser; and, FIG. 9 is a front perspective view of the razor holder shown with a razor cartridge dispenser and a razor. The various broken-line disclosures in the views are for illustrative purposes only and form no part of the claimed design.

[22] Filed: **Dec. 22, 1998**

[51] **LOC (7) Cl.** ..... **28-03**

[52] **U.S. Cl.** ..... **D6/526**

[58] **Field of Search** ..... D6/526; D3/205; 206/208, 210; 211/13.1

[56] **References Cited**

**U.S. PATENT DOCUMENTS**

- D. 60,325 2/1922 Drew ..... D6/526
- D. 181,876 1/1958 Nolan et al. .... D6/526

**1 Claim, 8 Drawing Sheets**

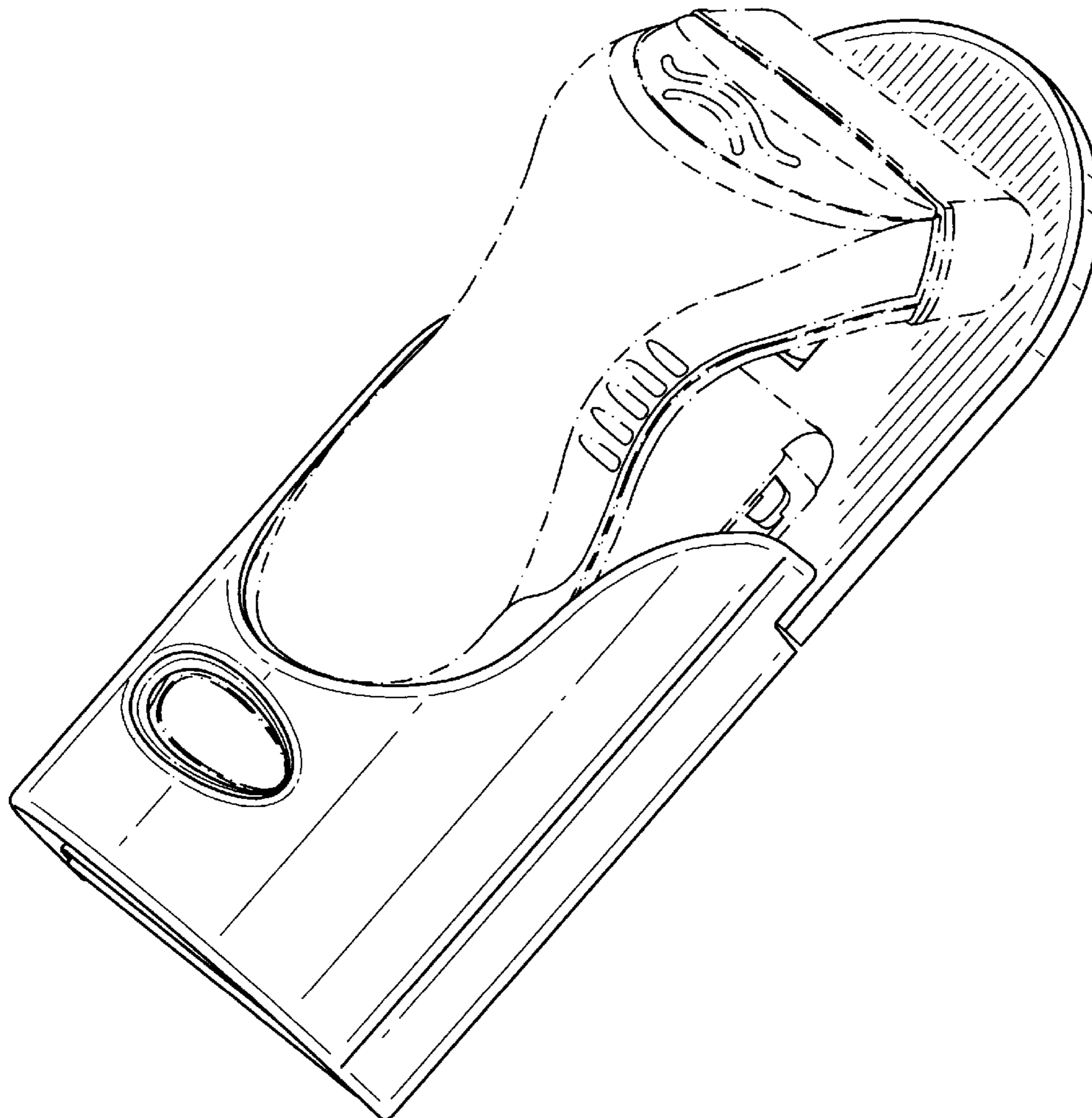

FIG-1

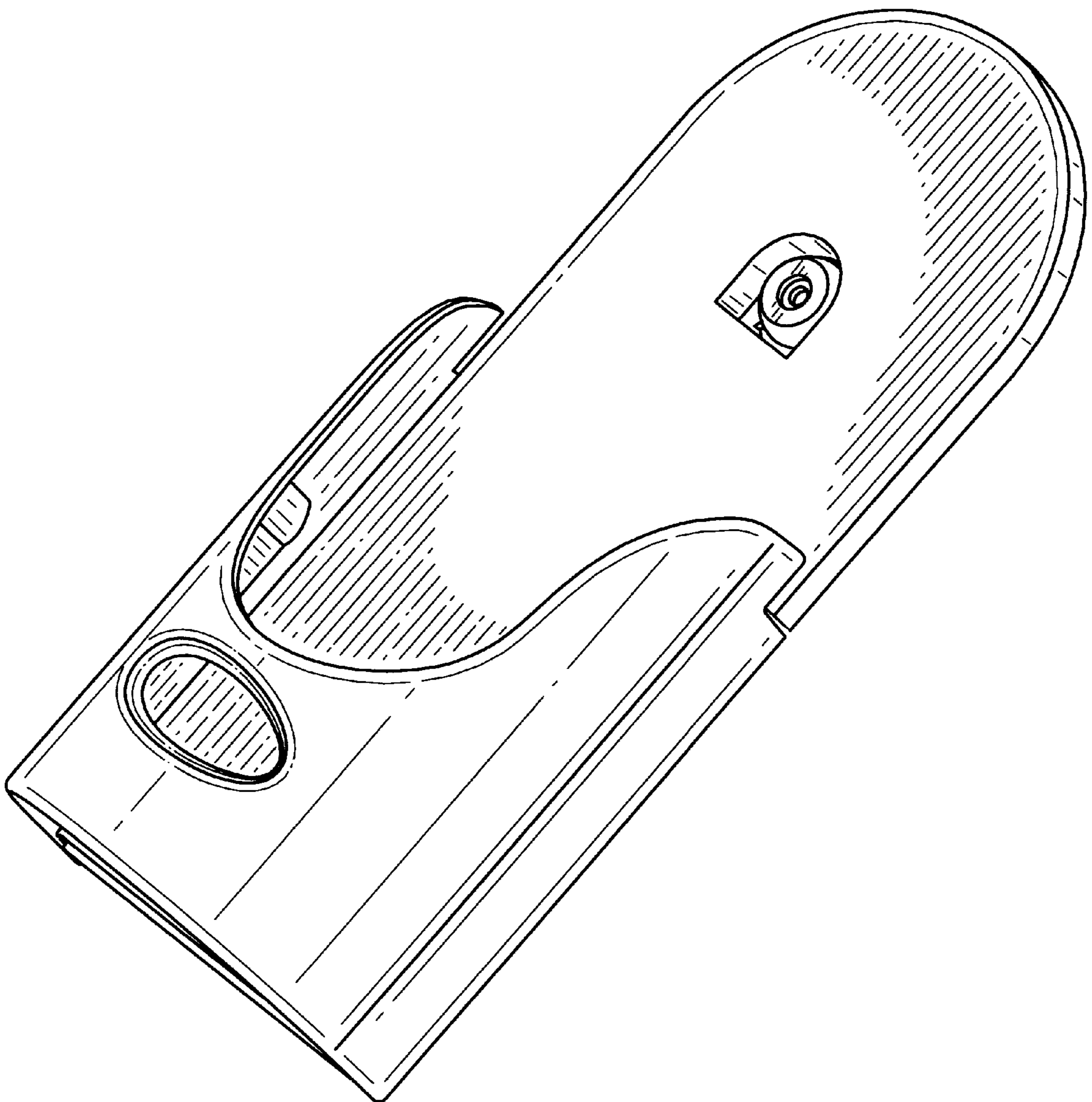

FIG-2

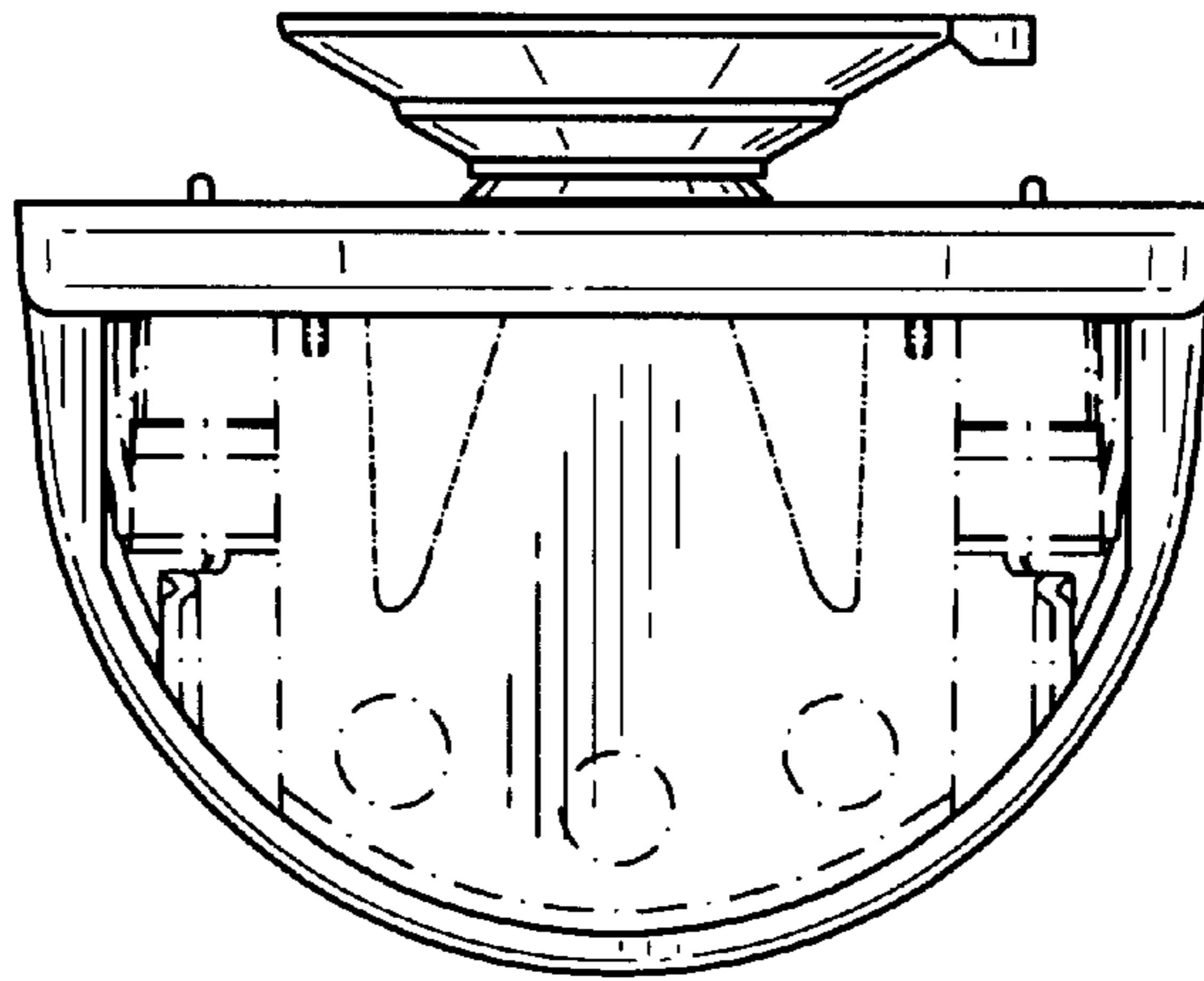

FIG-3

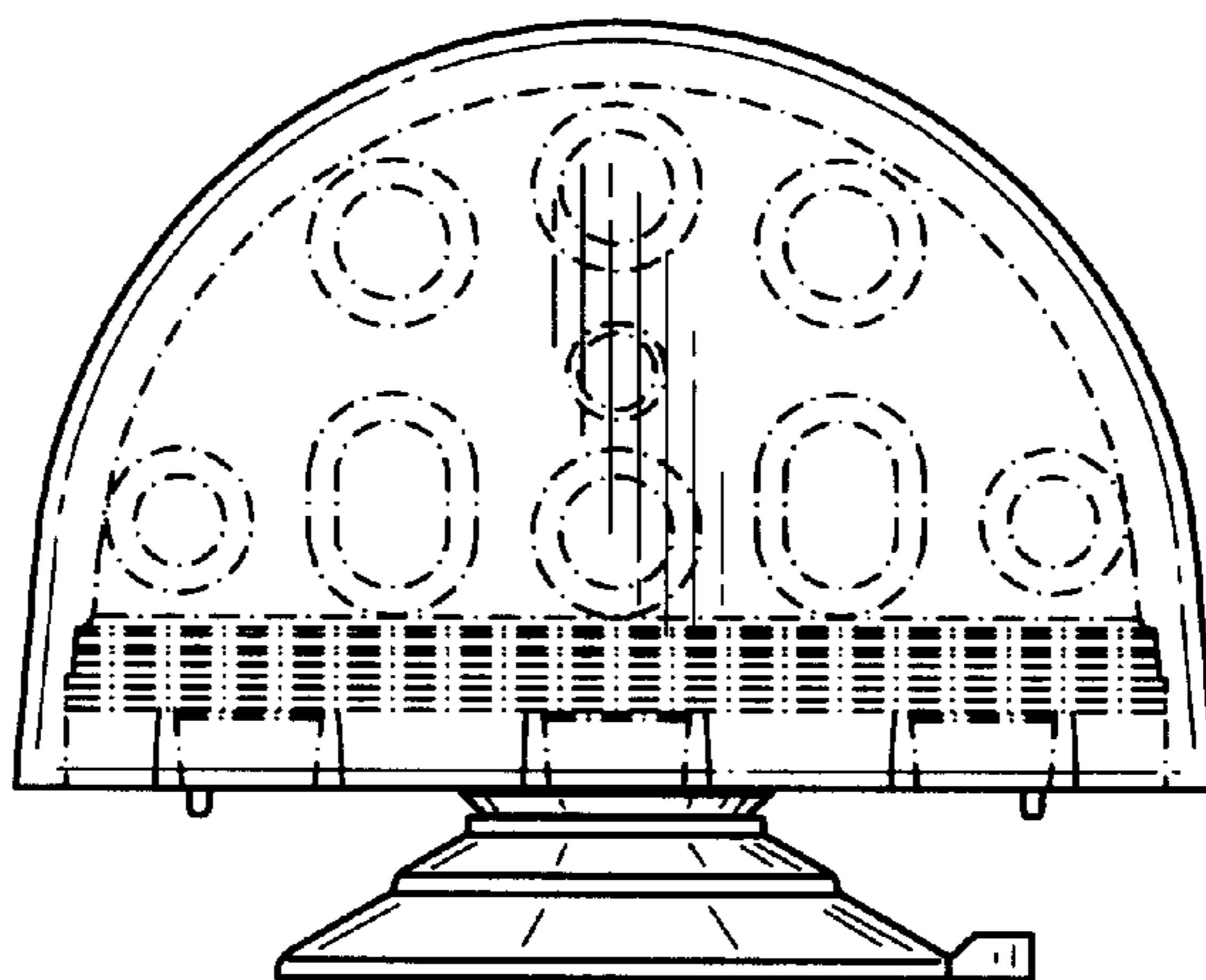

FIG-4

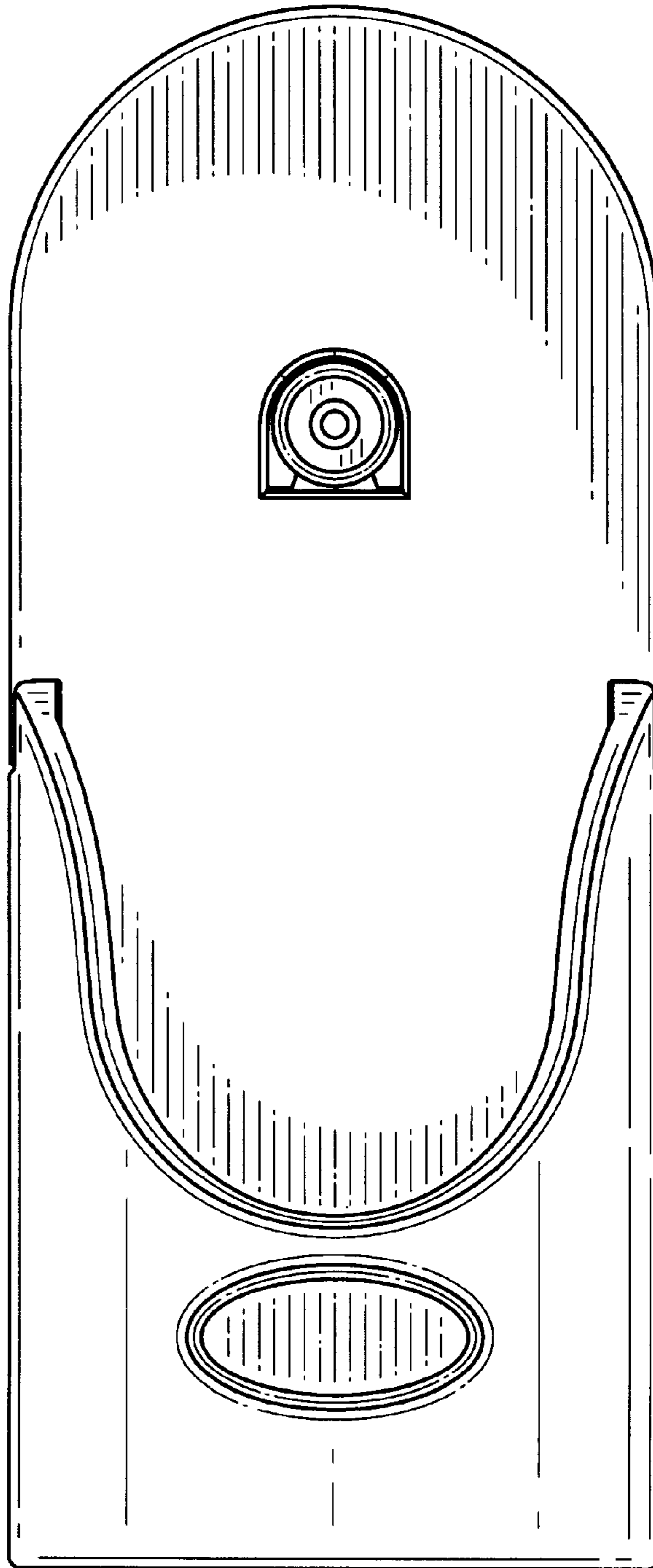

FIG-5

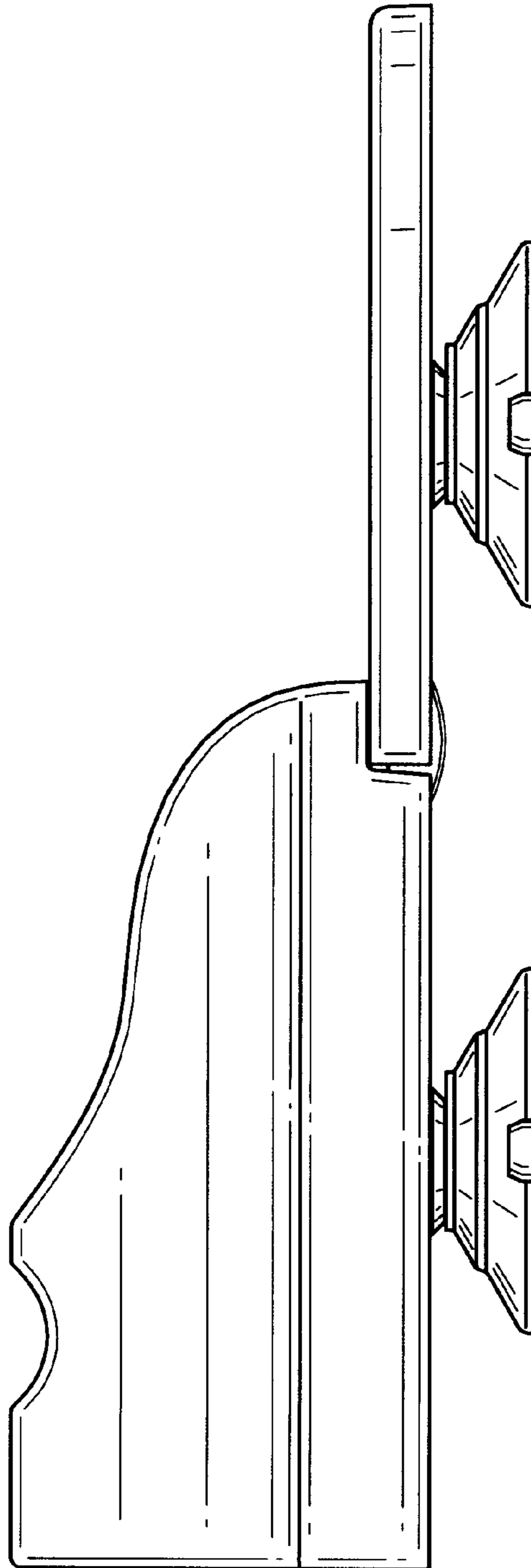

FIG-6

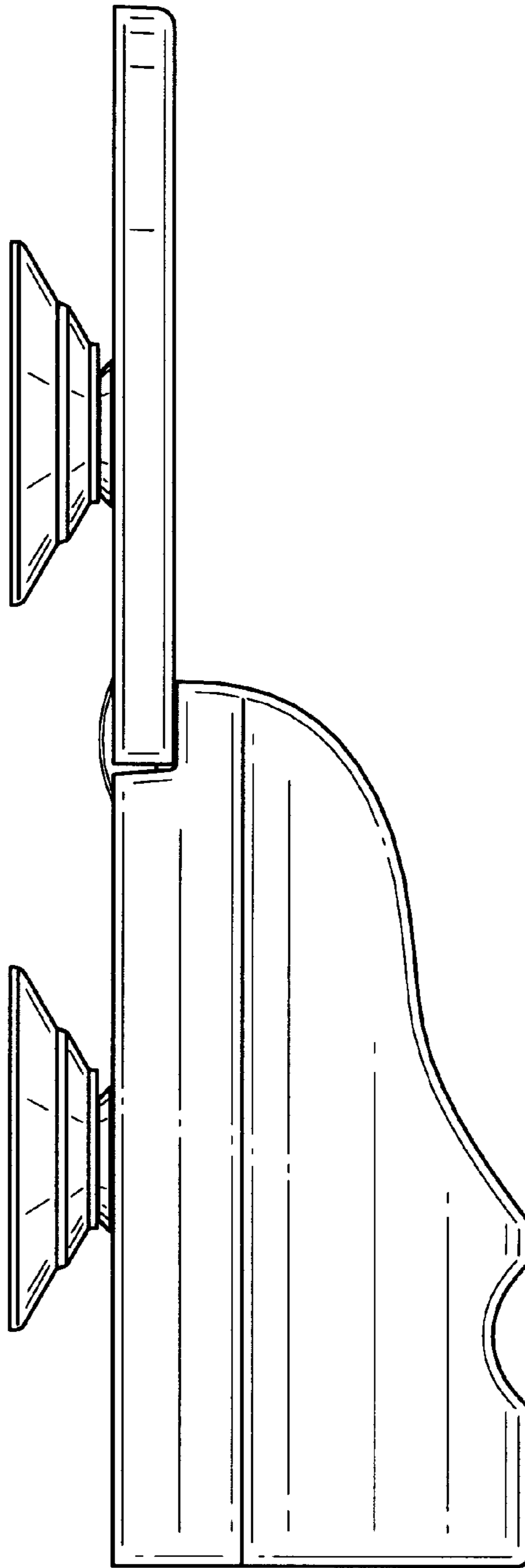

FIG-7

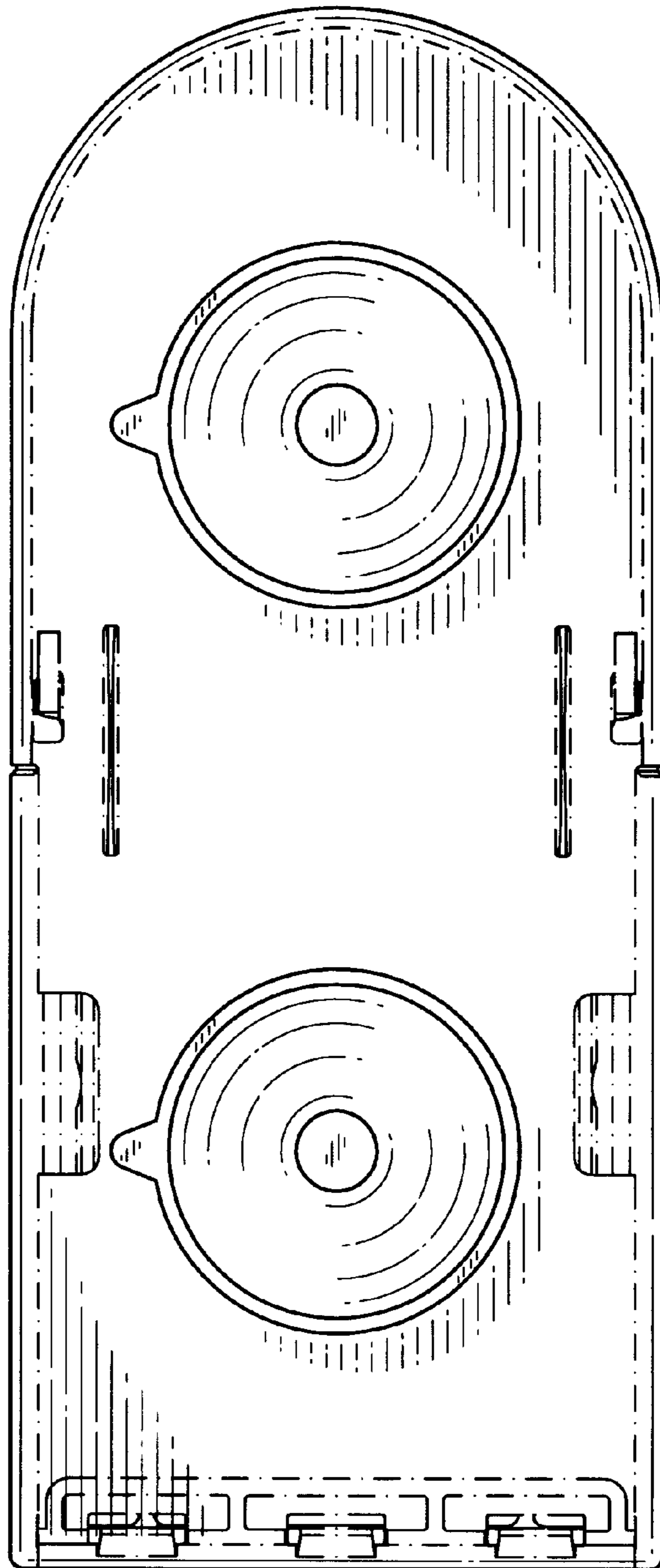

FIG-8

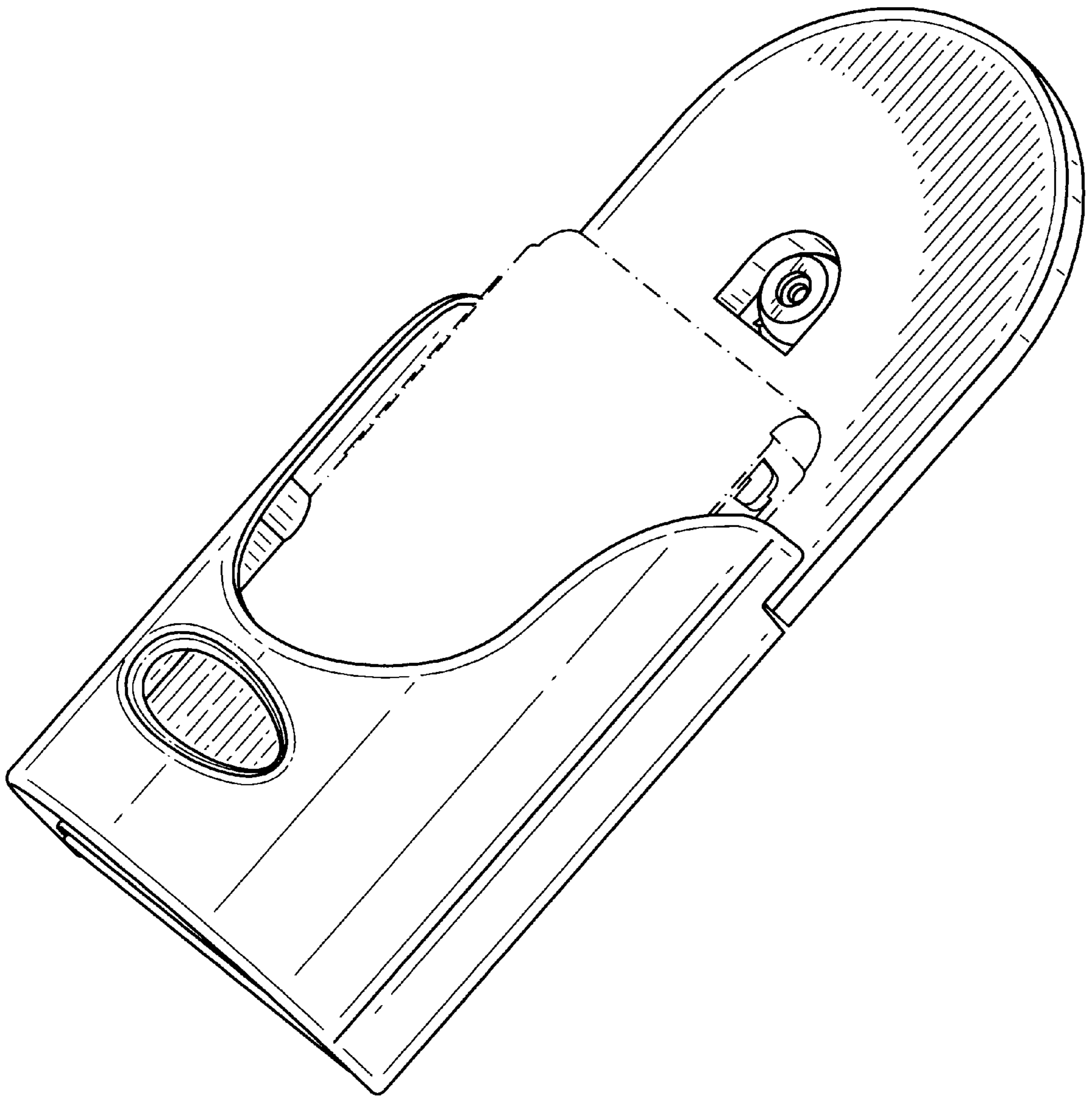



FIG-9

