



US00D423825S

United States Patent [19]

Alcala et al.

[11] Patent Number: **Des. 423,825**

[45] Date of Patent: **** May 2, 2000**

[54] **ROOM DIVIDER**

[75] Inventors: **Jose Alcala; Sofia Dumery; Sun Chul Kim**, all of Brooklyn, N.Y.; **Kimberly Leonard**, Washington, D.C.; **Andrew Schloss**, New York, N.Y.

[73] Assignee: **ABC School Supply, Inc.**, Duluth, Ga.

[**] Term: **14 Years**

[21] Appl. No.: **29/100,173**

[22] Filed: **Feb. 4, 1999**

[51] **LOC (7) Cl.** **06-04**

[52] **U.S. Cl.** **D6/478; D6/421**

[58] **Field of Search** D6/421-428, 477-479, D6/332; 160/135; 108/59, 60; 312/194-196, 223.2, 223.3, 198, 199, 242; 434/432; 211/105.1, 187, 13

[56] **References Cited**

U.S. PATENT DOCUMENTS

D. 210,134 2/1968 Christensen et al. D6/332 X

D. 248,437	7/1978	Robinson	D6/423
D. 328,830	8/1992	Allen	D6/478
D. 359,631	6/1995	Bubb	D6/421
D. 376,278	12/1996	Zivari	D6/421
D. 421,625	8/1999	Montague, III et al.	D6/421
3,513,985	5/1970	Acton	108/60

Primary Examiner—Carmen H. Vales-Lado
Attorney, Agent, or Firm—Louis T. Isaf; Womble Carlyle Sandridge & Rice

[57] **CLAIM**

The ornamental design for a “room divider”, as shown and described.

DESCRIPTION

FIG. 1 is a perspective view of a room divider showing our new design;
FIG. 2 is a front elevational view thereof;
FIG. 3 is a rear elevational view thereof;
FIG. 4 is a left side elevational view as seen when in use;
FIG. 5 is a right side elevational view as seen when in use; and,
FIG. 6 is a top plan view thereof.

1 Claim, 3 Drawing Sheets

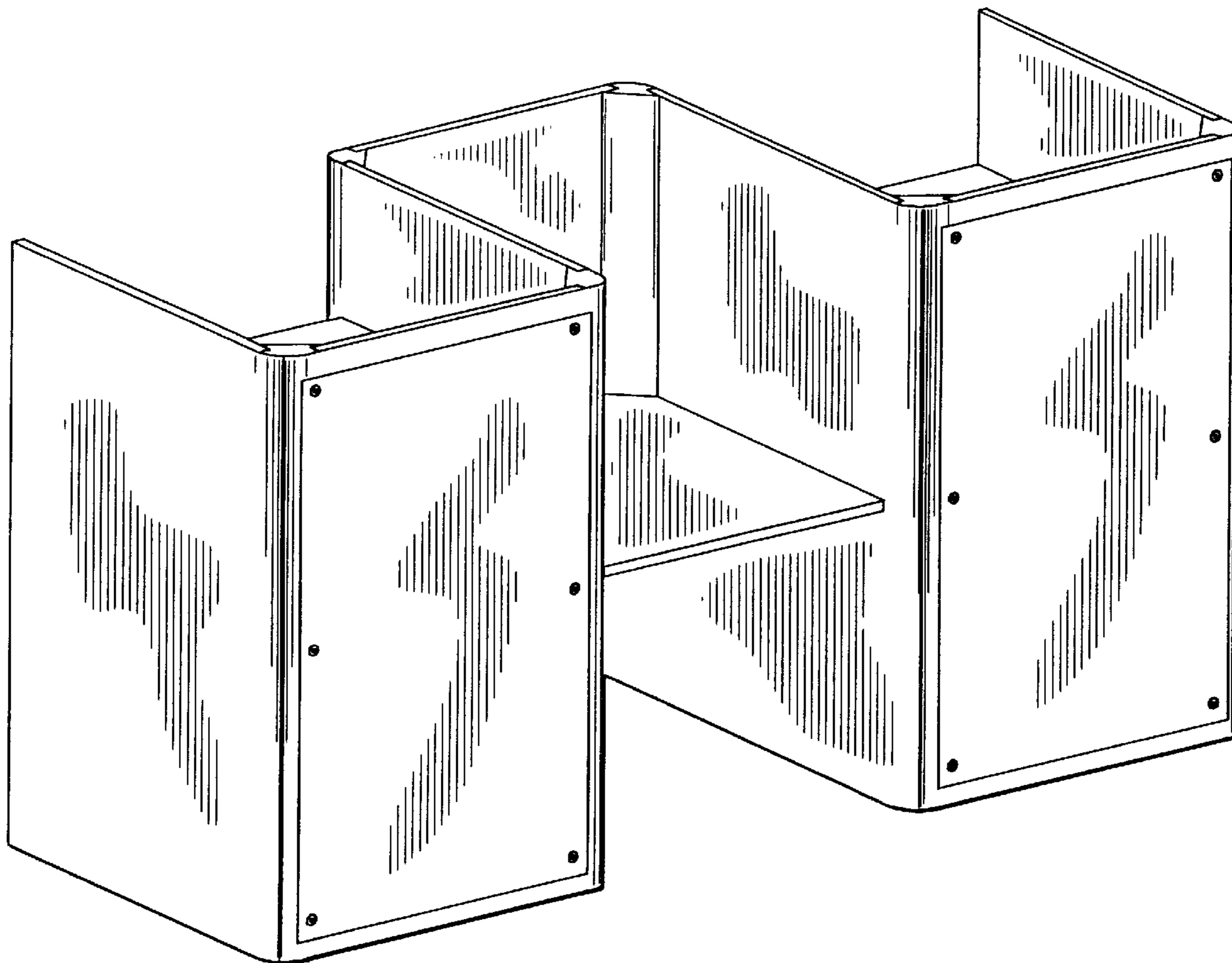

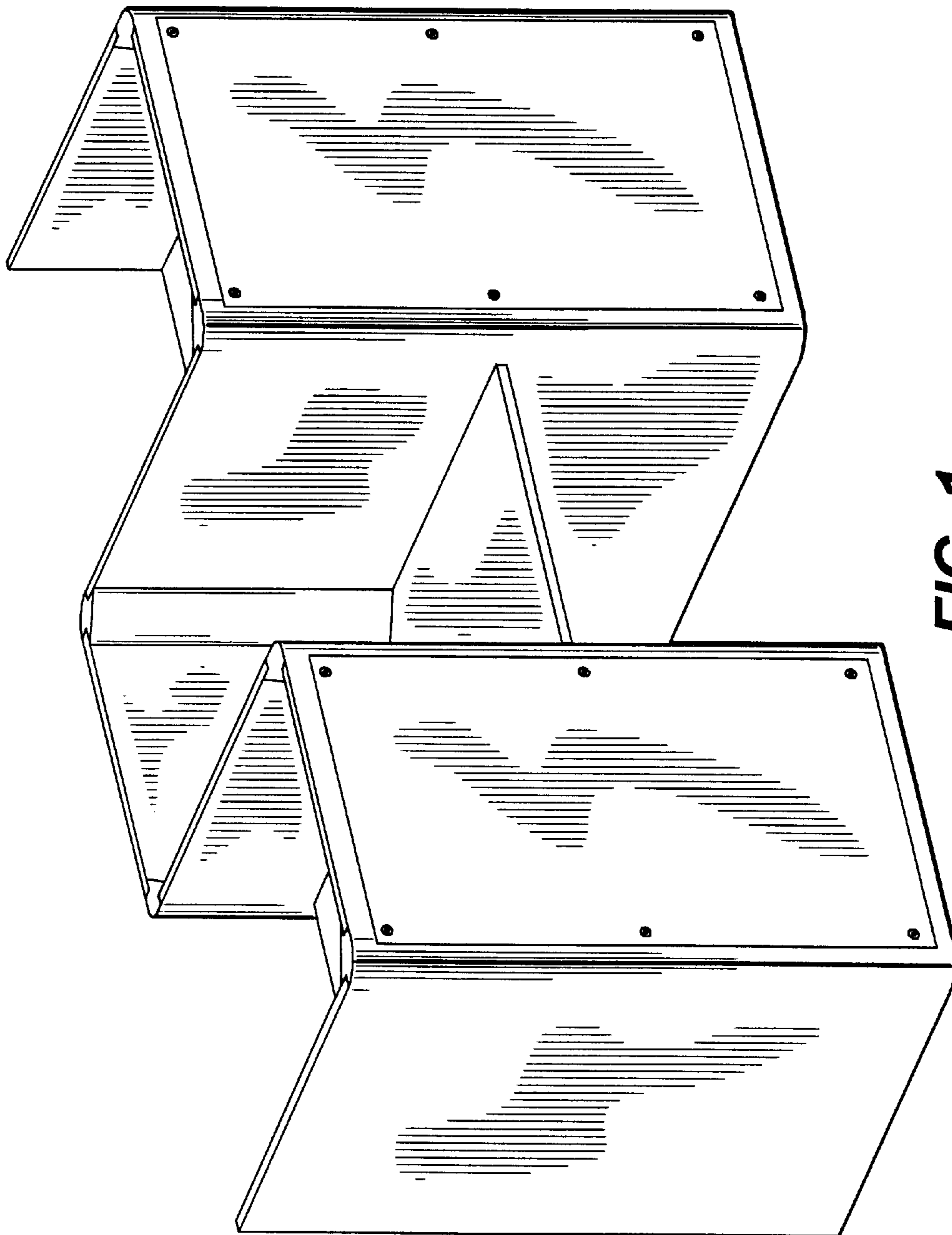

FIG. 1

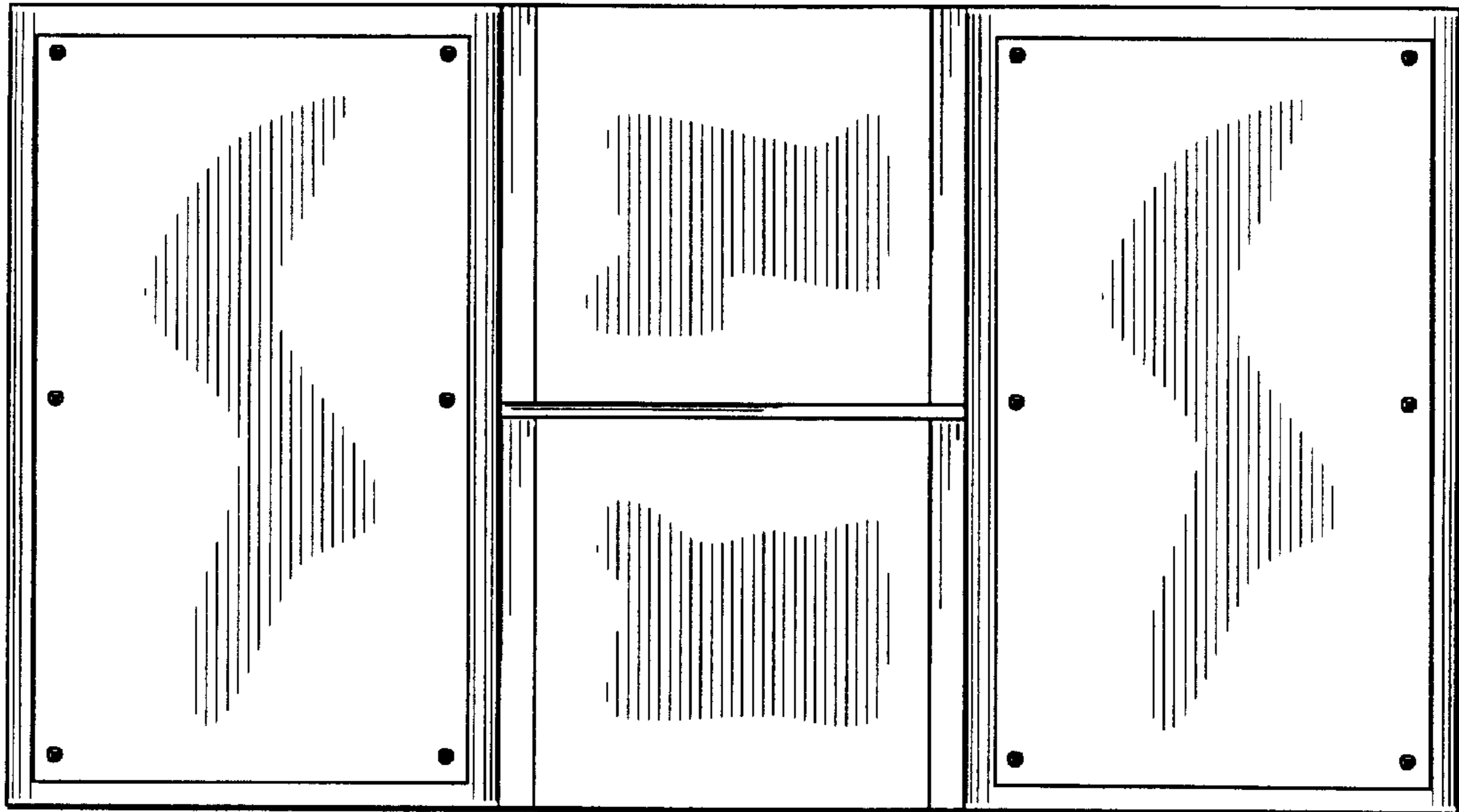

FIG. 2

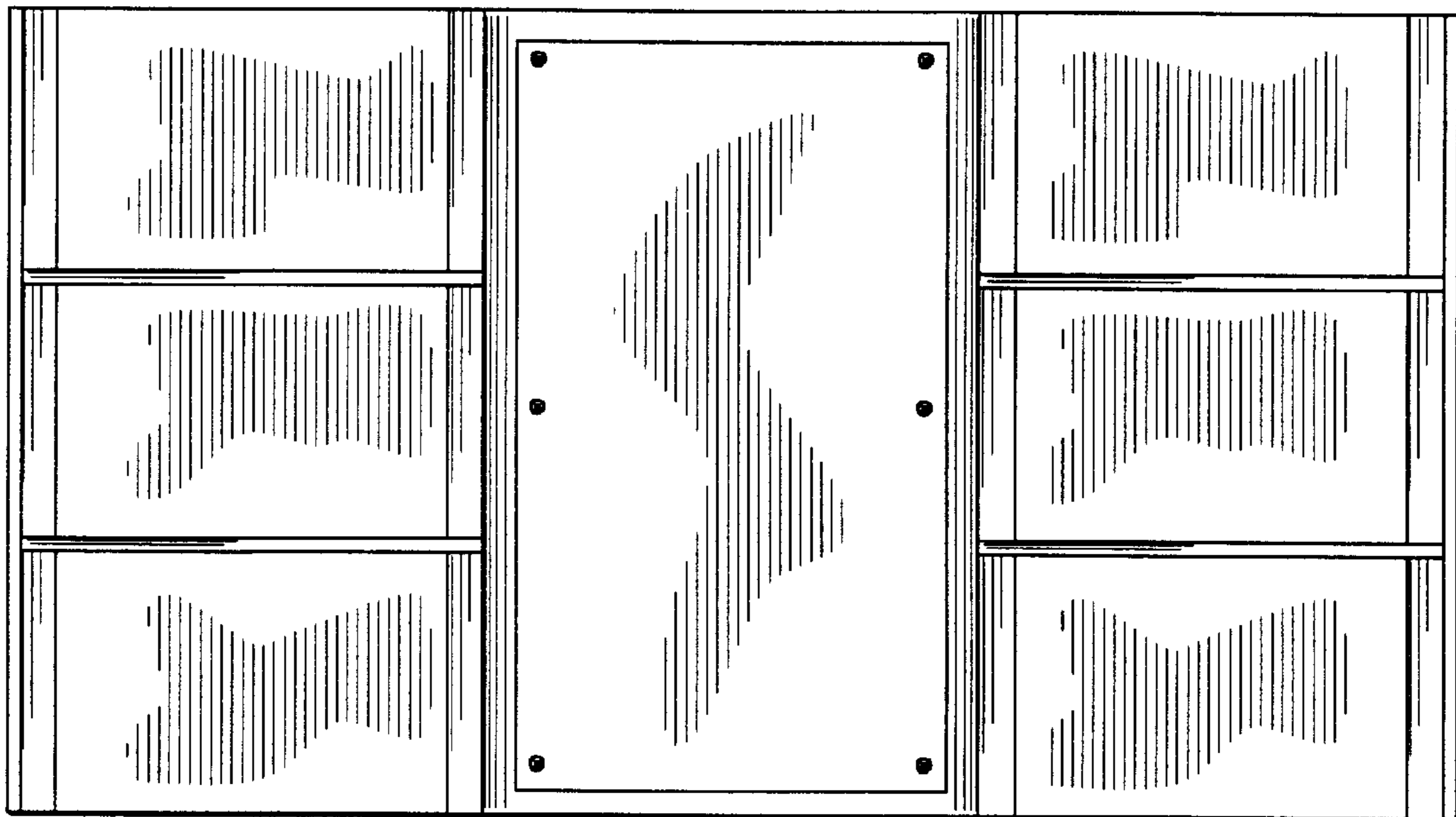

FIG. 3

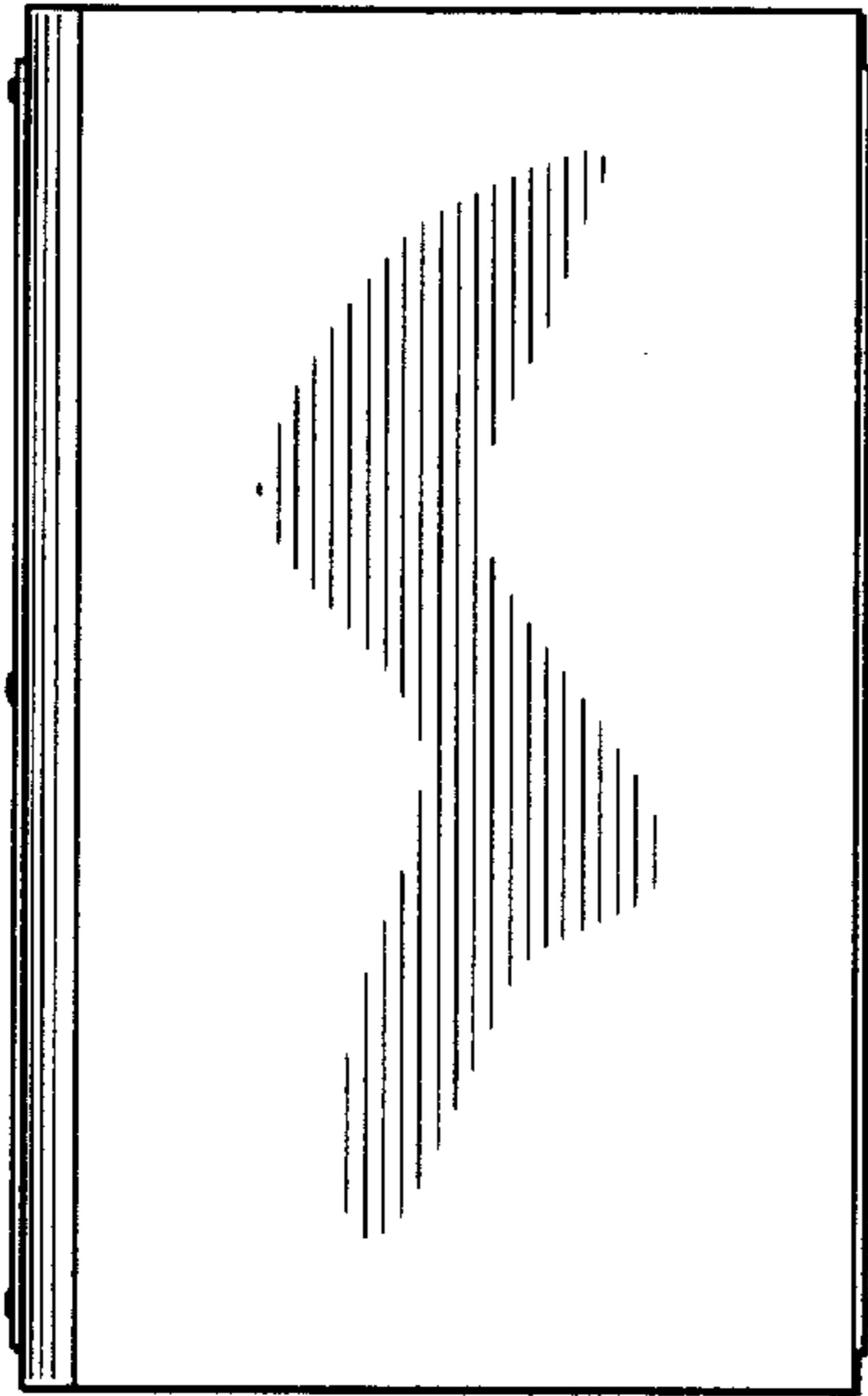

FIG. 4

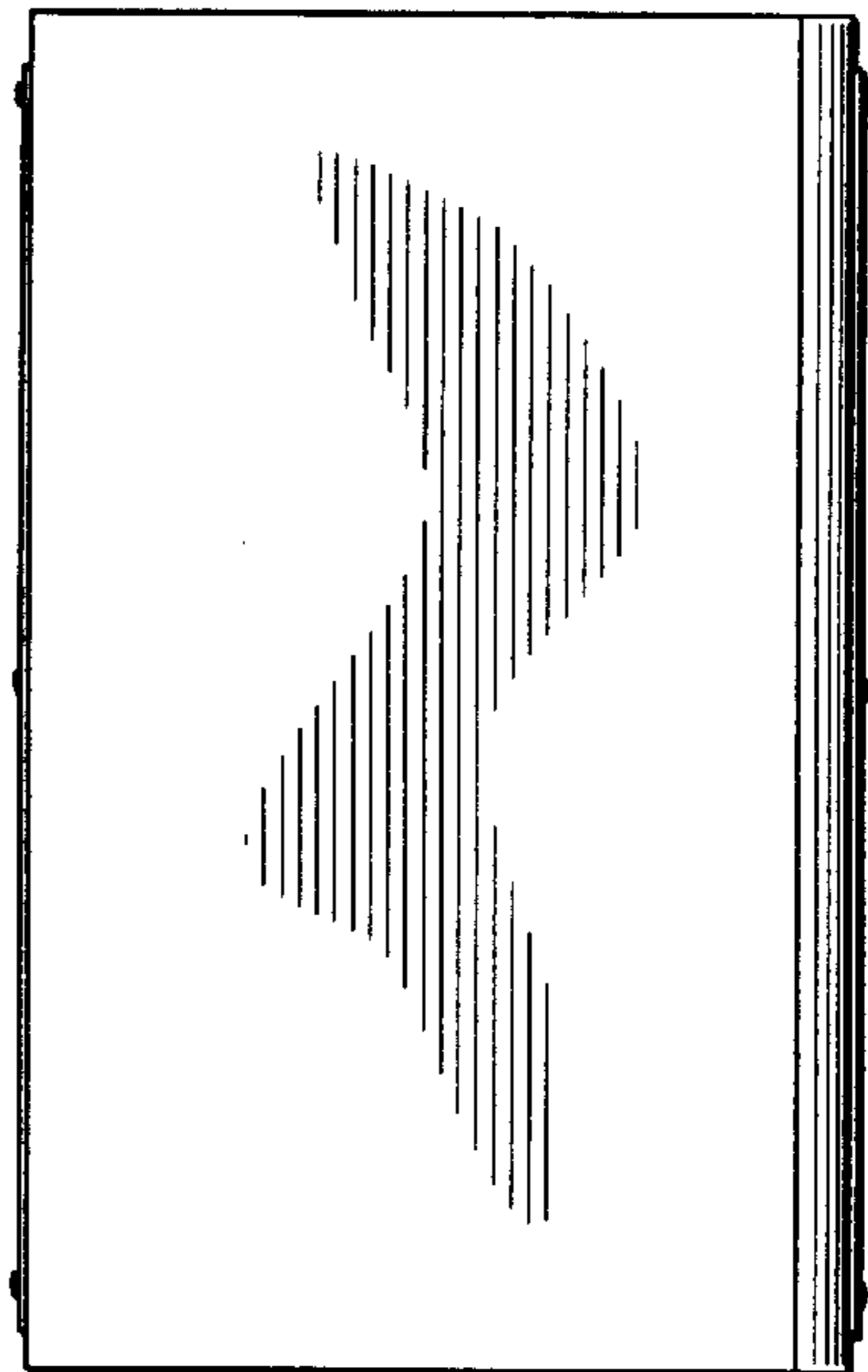

FIG. 5

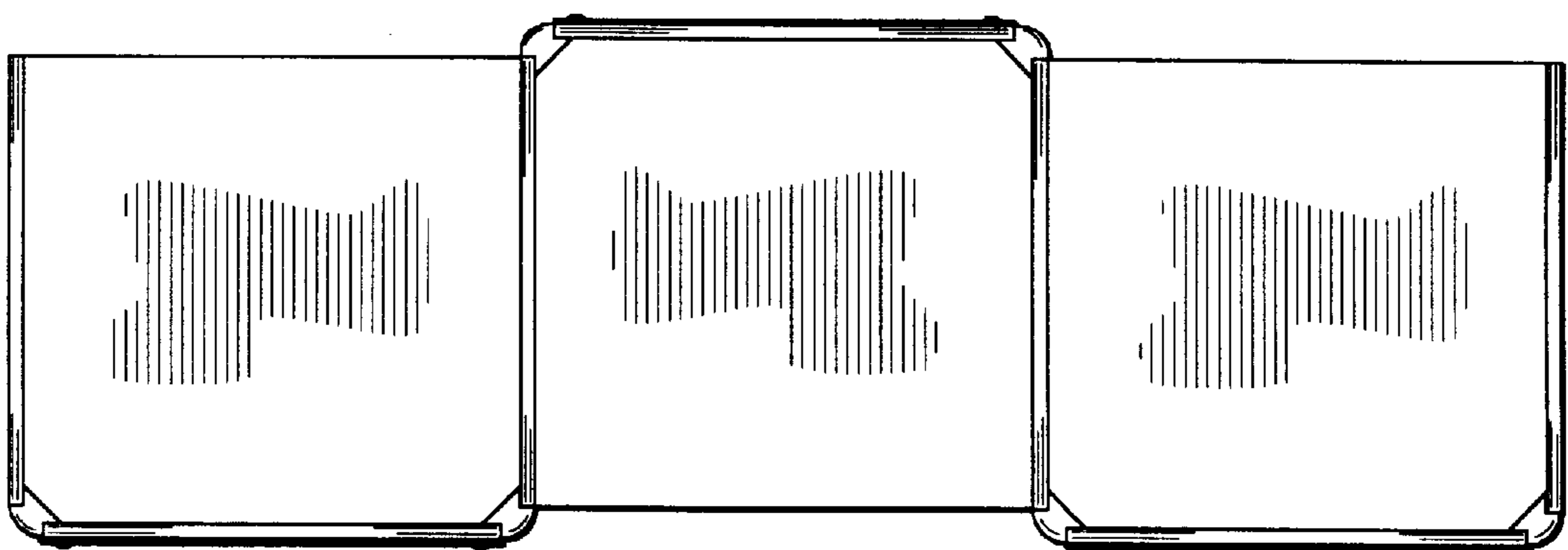

FIG. 6