



US00D423808S

United States Patent [19]

[11] **Patent Number: Des. 423,808**

Natuzzi et al.

[45] **Date of Patent: ** May 2, 2000**

[54] **SEAT**

[75] Inventors: **Pasquale Natuzzi**, Bari; **Arcangelo Scarati**, Taranto, both of Italy

[73] Assignee: **Industrie Natuzzi SpA**, Bari, Italy

[**] Term: **14 Years**

[21] Appl. No.: **29/103,952**

[22] Filed: **Apr. 23, 1999**

[51] **LOC (7) Cl.** **06-01**

[52] **U.S. Cl.** **D6/381; D6/334**

[58] **Field of Search** D6/334, 335, 336, D6/364, 371, 373, 381, 500, 501, 502; 5/12.1; 297/232, 445.1, 446.1

[56] **References Cited**

U.S. PATENT DOCUMENTS

D. 98,545	2/1936	Pumphrey	D6/364
D. 98,546	2/1936	Pumphrey	D6/364
D. 239,580	4/1976	Robertson et al.	D6/371
D. 257,454	10/1980	Nash	D6/364
D. 283,275	4/1986	Culler	D6/371
D. 329,543	9/1992	Shields	D6/334
D. 367,364	2/1996	Lewis	D6/334
D. 368,377	4/1996	Laslo	D6/334
D. 369,478	5/1996	Riboldi	D6/381
D. 373,257	9/1996	Hutton	D6/381
D. 373,911	9/1996	Paus	D6/381
D. 379,269	5/1997	Hutton	D6/334
D. 382,129	8/1997	Lewis	D6/381
D. 388,630	1/1998	Lowman et al.	D6/381
D. 403,167	12/1998	Hutton	D6/334
D. 404,212	1/1999	Hutton	D6/381

OTHER PUBLICATIONS

Natuzzi Model 156, at least as early as 1986, at International Home Furnishings Market in High Point, North Carolina.
 Natuzzi Model 446, Apr. 1988, at International Home Furnishings Market in High Point, North Carolina.
 Natuzzi Model 448, Apr. 1989, at International Home Furnishings Market in High Point, North Carolina.
 Natuzzi Model 926, Apr. 1992, at International Home Furnishings Market in High Point, North Carolina.

Natuzzi Model 1001, Mar. 1993, at International Home Furnishings Market in High Point, North Carolina.
 Natuzzi Model 1013, Mar. 1993, at International Home Furnishings Market in High Point, North Carolina.
 Natuzzi Model 1025, Mar. 1993, at International Home Furnishings Market in High Point, North Carolina.
 Natuzzi Model 1032, Apr. 1993, at International Home Furnishings Market in High Point, North Carolina.
 Natuzzi Model 1054, Apr. 1993, at International Home Furnishings Market in High Point, North Carolina.
 Natuzzi Model 1084, Sep. 1993, at International Home Furnishings Market in High Point, North Carolina.
 Natuzzi Model 1088, Sep. 1993, at International Home Furnishings Market in High Point, North Carolina.
 Natuzzi Model 1124, Jan. 1994, at International Home Furnishings Market in High Point, North Carolina.

(List continued on next page.)

Primary Examiner—Gary D. Watson
Attorney, Agent, or Firm—Alston & Bird LLP

[57] **CLAIM**

The ornamental design for a seat, as shown and described.

DESCRIPTION

FIG. 1 is a front perspective view of a seat showing our new design in the form of a sofa;
 FIG. 2 is a front elevational view thereof;
 FIG. 3 is a top plan view thereof;
 FIG. 4 is a right side elevational view, the left side being a mirror image thereof;
 FIG. 5 is a rear perspective view thereof;
 FIG. 6 is a front elevational view of a seat showing our new design in the form of a loveseat; and,
 FIG. 7 is a front elevational view of a seat showing our new design in the form of a chair.
 The broken lines shown herein are for illustrative purposes only and form no part of the claimed design.
 The rear views of FIGS. 6 and 7 are like FIG. 5, the difference being a matter of length.
 The end views of FIGS. 6 and 7 are like FIG. 4.
 FIG. 1 has been shown on an enlarged scale with respect to the other views.

1 Claim, 3 Drawing Sheets

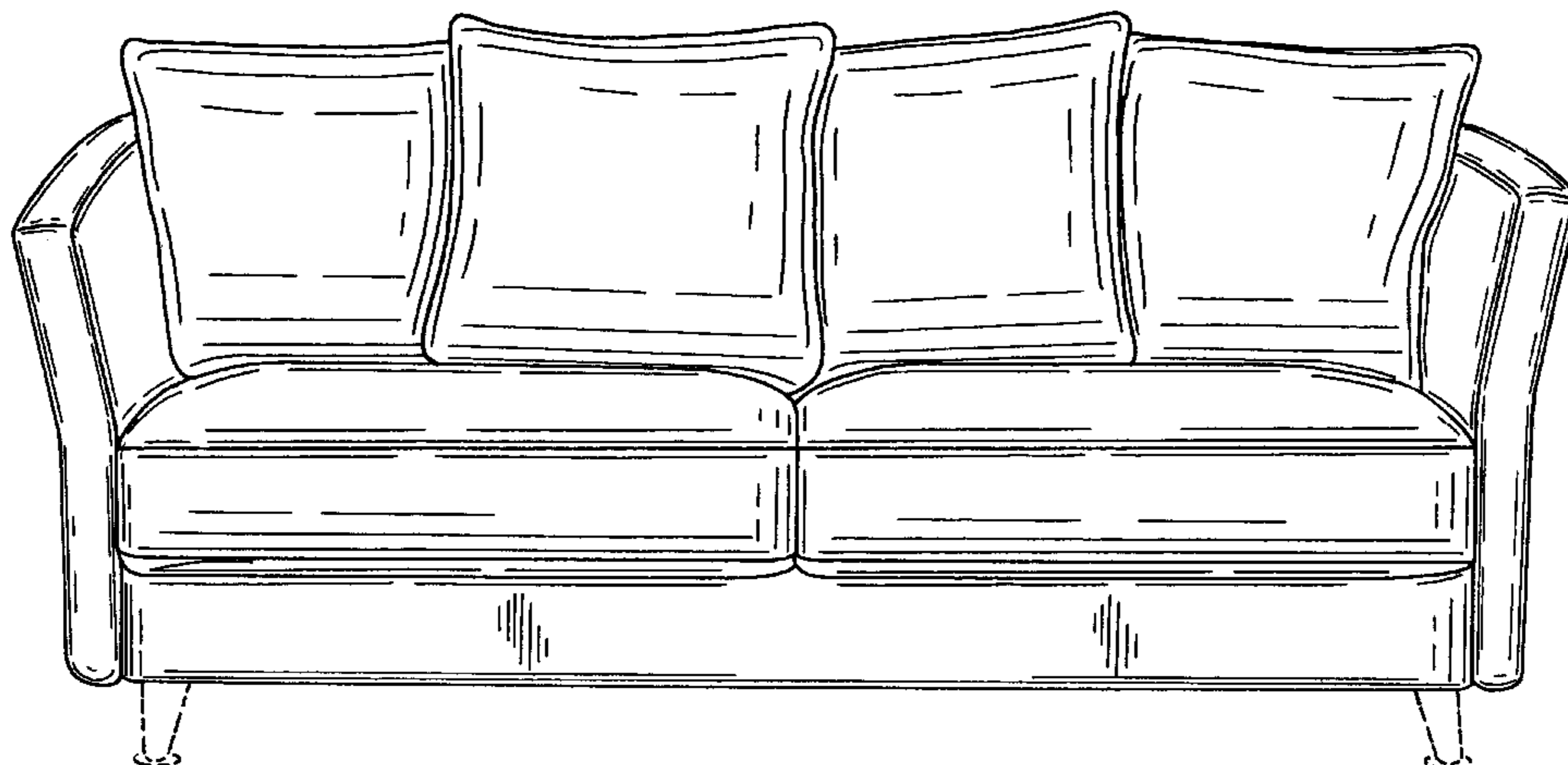

OTHER PUBLICATIONS

Natuzzi Model 1137, Apr. 1994, at International Home Furnishings Market in High Point, North Carolina.
Natuzzi Model 1180, Apr. 1994, at International Home Furnishings Market in High Point, North Carolina.
Natuzzi Model 1209, Oct. 1994, at International Home Furnishings Market in High Point, North Carolina.
Natuzzi Model 1216, Oct. 1994, at International Home Furnishings Market in High Point, North Carolina.
Natuzzi Model 1217, Oct. 1994, at International Home Furnishings Market in High Point, North Carolina.
Natuzzi Model 1275, Mar. 1995, at International Home Furnishings Market in High Point, North Carolina.

Natuzzi Model 1306, Mar. 1995, at International Home Furnishings Market in High Point, North Carolina.

Natuzzi Model 1325, Sep. 1995, at International Home Furnishings Market in High Point, North Carolina.

Natuzzi Model 1338, Sep. 1995, at International Home Furnishings Market in High Point, North Carolina.

Natuzzi Model 1424, Apr. 1996, at International Home Furnishings Market in High Point, North Carolina.

Natuzzi Model 1437, Mar. 1996, at International Home Furnishings Market in High Point, North Carolina.



FIG. 1.

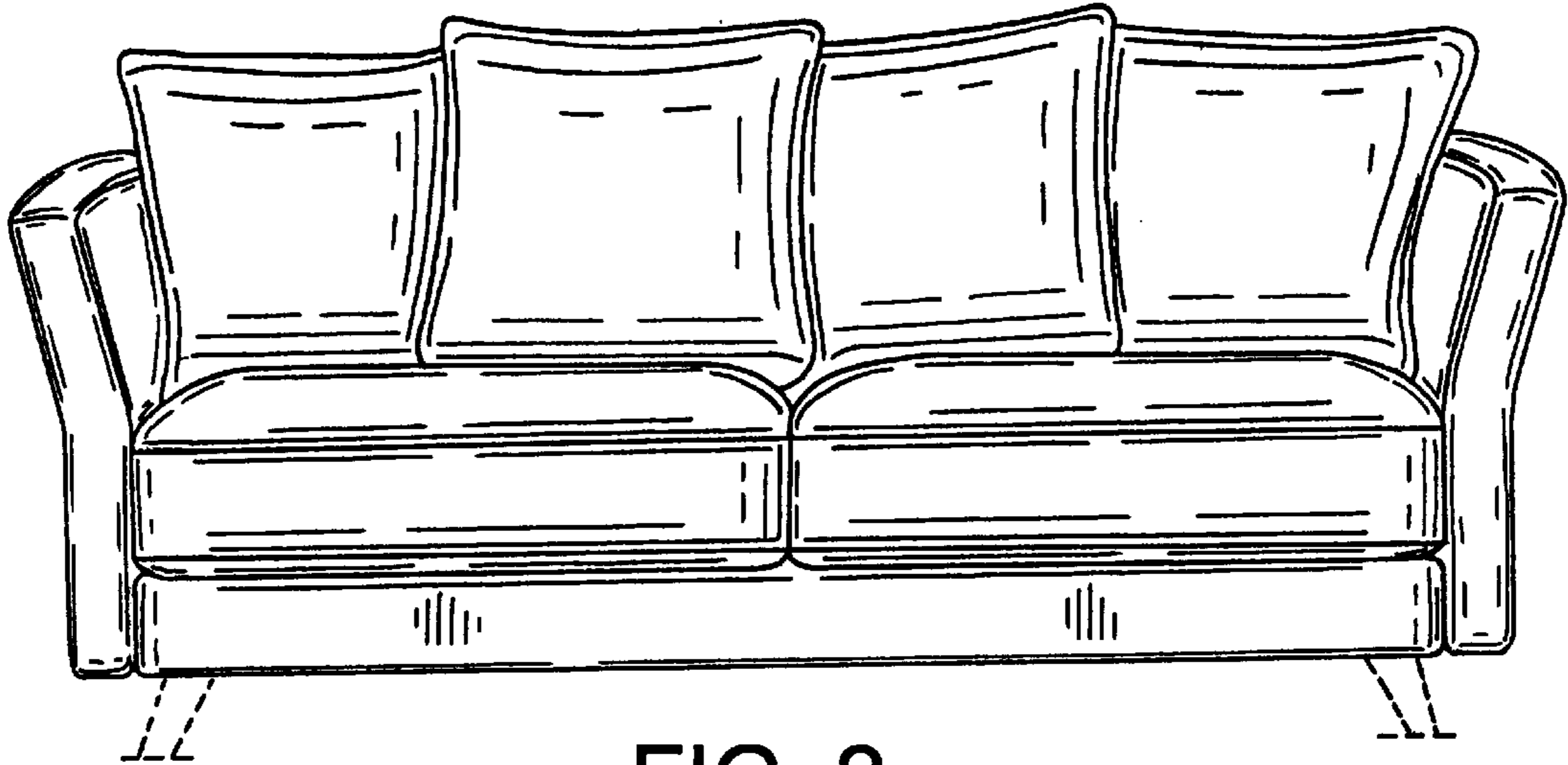

FIG. 2.

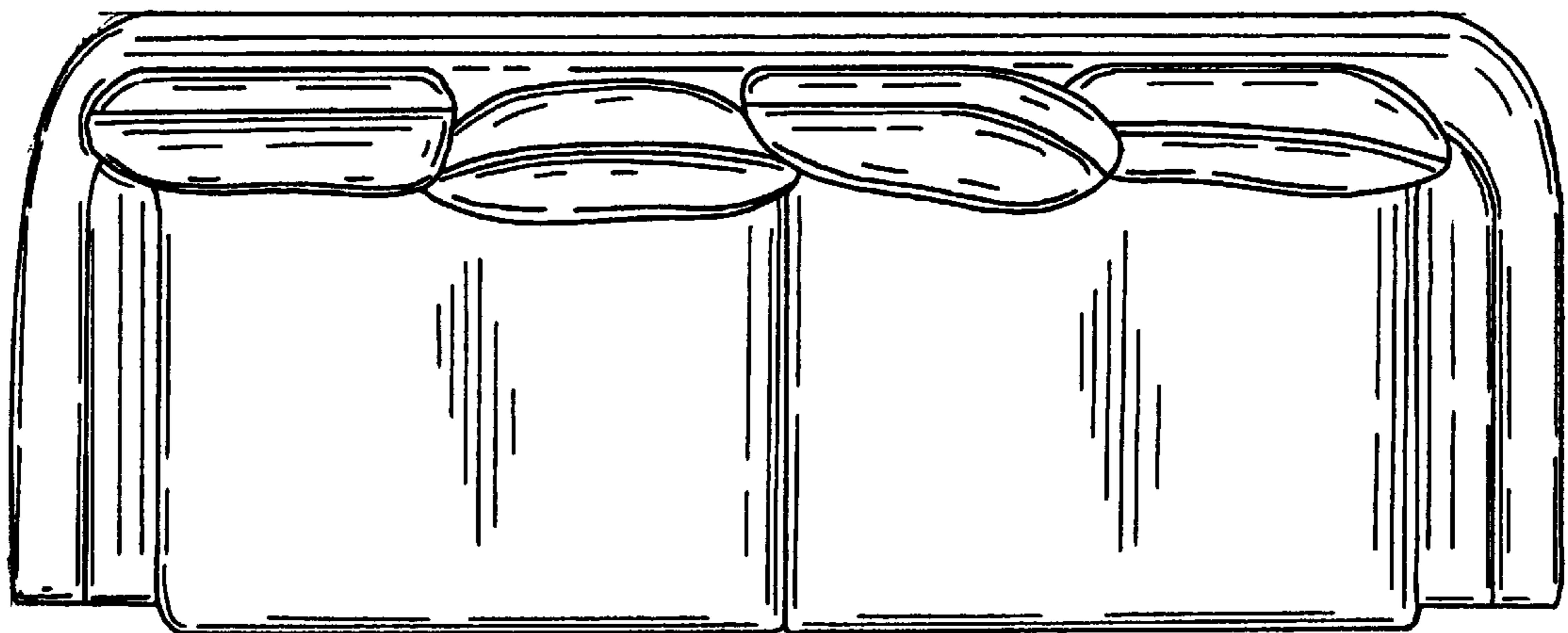

FIG. 3.

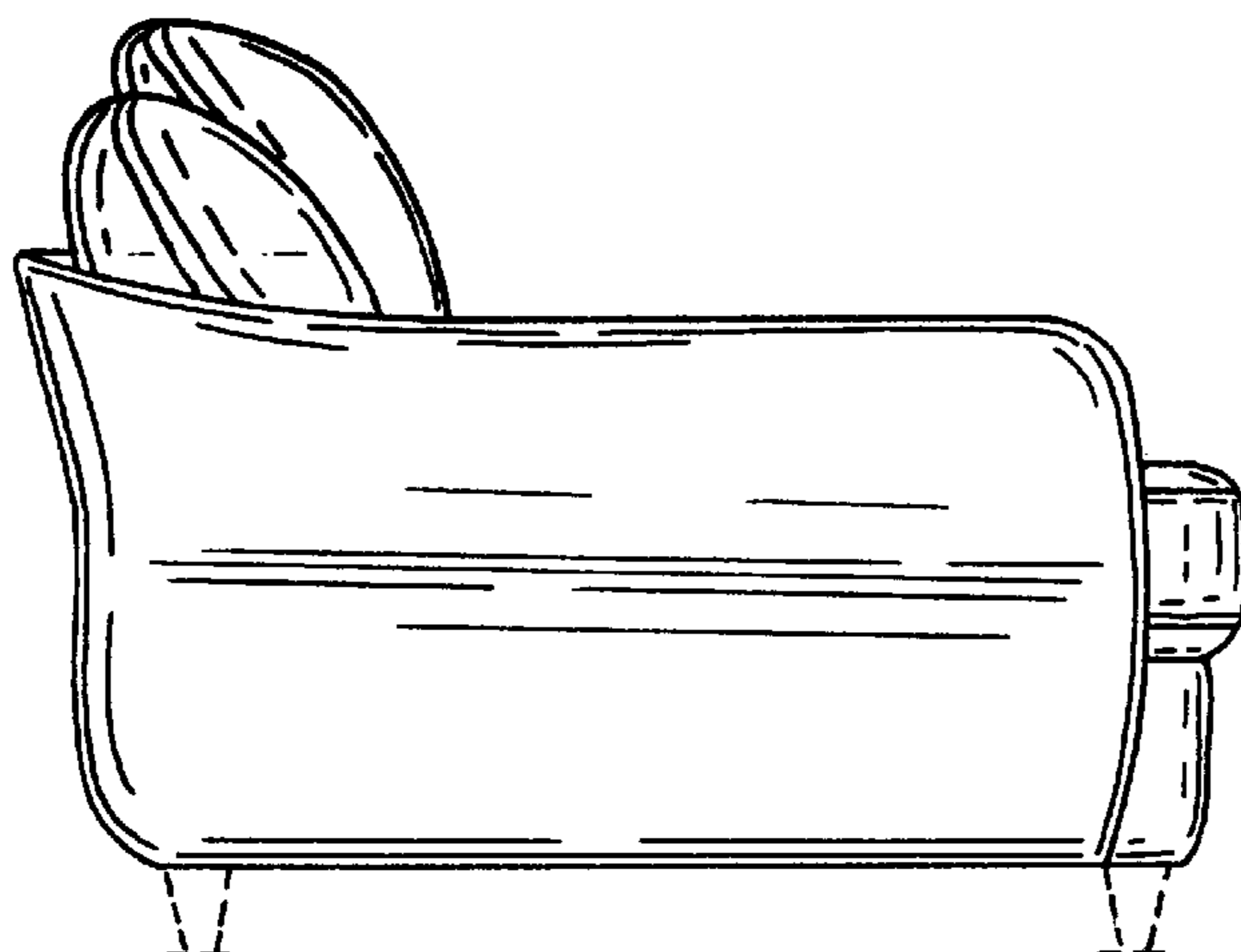

FIG. 4.

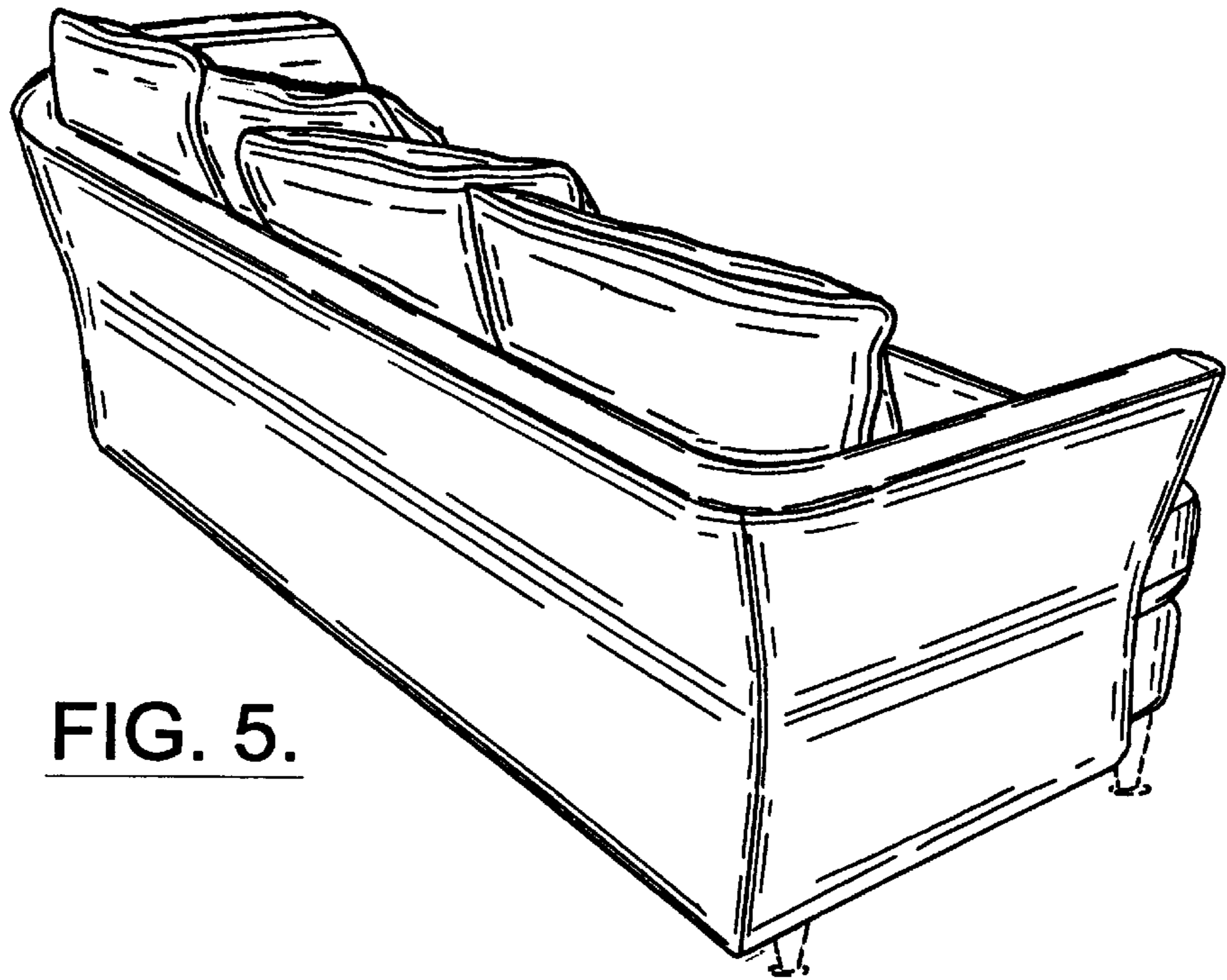

FIG. 5.

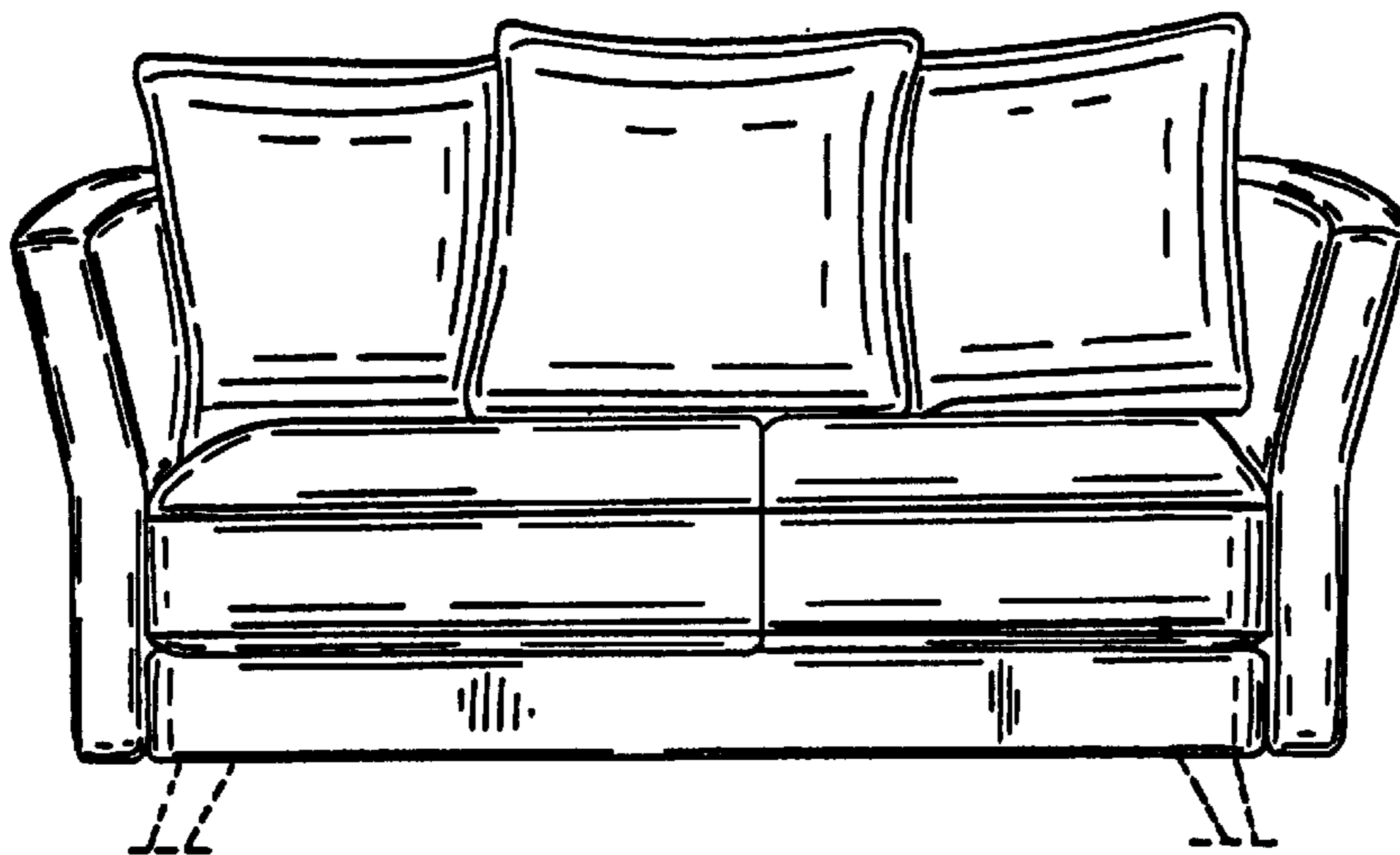

FIG. 6.

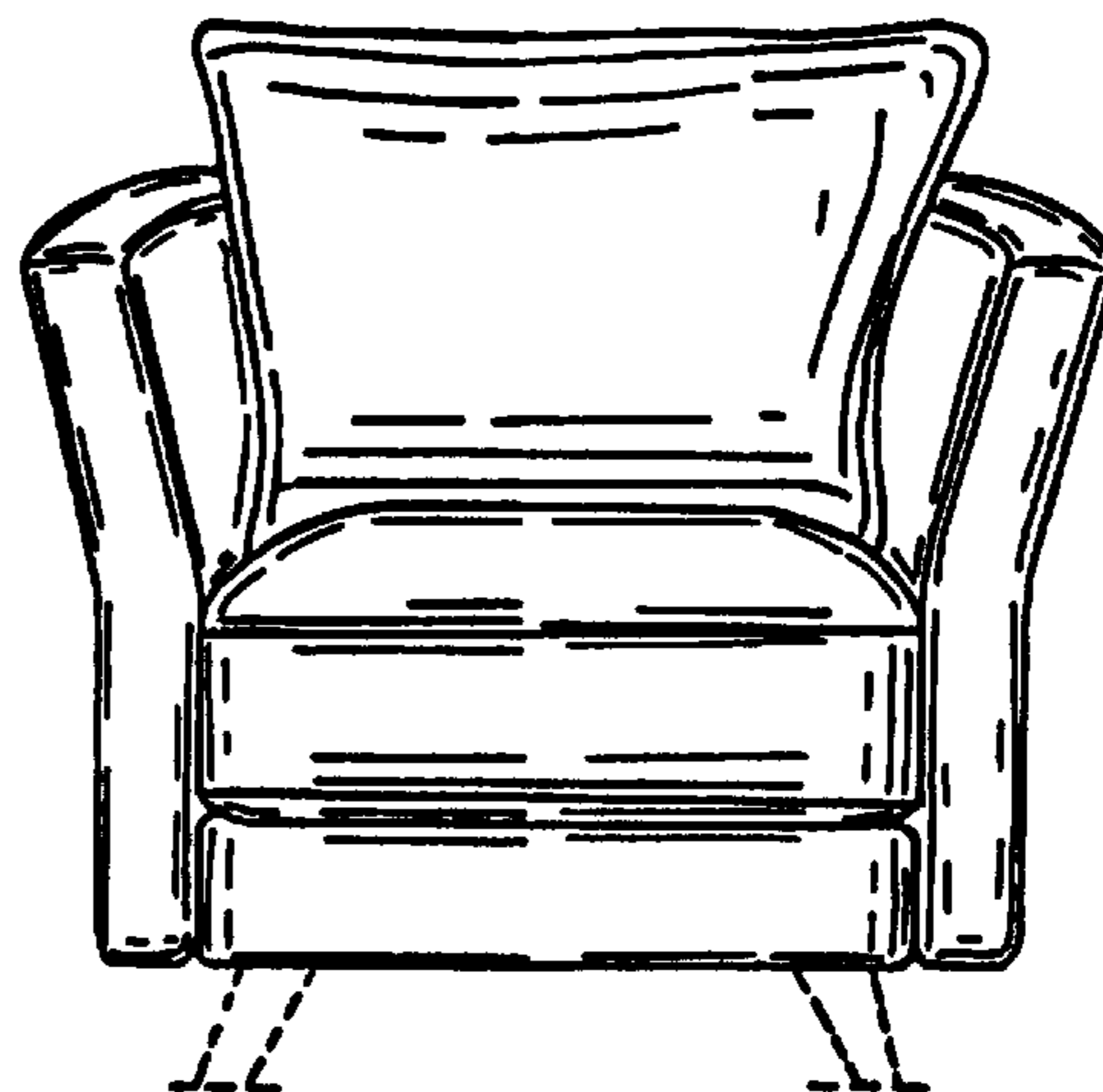

FIG. 7.

UNITED STATES PATENT AND TRADEMARK OFFICE
CERTIFICATE OF CORRECTION

PATENT NO. : Des. 423,808
DATED : May 2, 2000
INVENTOR(S) : Natuzzi et al.

It is certified that error appears in the above-identified patent and that said Letters Patent is hereby corrected as shown below:

Title page, [56] References Cited, OTHER PUBLICATIONS, line 5, "448" should read --488--; line 16, "is" should read --in--.

Signed and Sealed this
Twenty-seventh Day of March, 2001

Attest:



NICHOLAS P. GODICI

Attesting Officer

Acting Director of the United States Patent and Trademark Office