



US00D423729S

United States Patent [19] Morgan

[11] Patent Number: **Des. 423,729**

[45] Date of Patent: **** Apr. 25, 2000**

[54] **PET BED**

5,311,837 5/1994 Mamer-Boellstorff 119/28.5
5,832,874 11/1998 Ravin 119/496

[75] Inventor: **Charles Morgan**, Derbyshire, United Kingdom

Primary Examiner—Cathy Anne MacCormac
Attorney, Agent, or Firm—Watts, Hoffmann, Fisher, & Heinke Co.

[73] Assignee: **Snaffles Pet Furniture Limited**, Newbury, United Kingdom

[**] Term: **14 Years**

[57] CLAIM

The ornamental design of the pet bed, as described.

[21] Appl. No.: **29/098,183**

DESCRIPTION

[22] Filed: **Dec. 22, 1998**

FIG. 1 is a perspective view of a pet bed showing my new design;

[51] **LOC (6) Cl.** **30-06**

FIG. 2 is a side elevational view thereof;

[52] **U.S. Cl.** **D30/118; D6/334; D30/161**

FIG. 3 is a front elevational view thereof;

[58] **Field of Search** D6/334, 388; 119/161–170, 119/496, 482, 484, 706, 498, 497, 28.5; D30/118, 161

FIG. 4 is a rear elevational view thereof;

FIG. 5 is a top plan view thereof;

FIG. 6 is a bottom plan view thereof;

FIG. 7 is a perspective view of a second embodiment of FIG. 1;

[56] References Cited

U.S. PATENT DOCUMENTS

D. 124,557	1/1941	Richardson	119/28.5
D. 151,291	10/1948	Shoemaker et al.	D30/118
D. 208,920	10/1967	Dvore	D30/118
D. 233,285	10/1974	Gill et al.	D30/118
D. 289,572	4/1987	Wanat	D30/118
D. 336,387	6/1993	Martin	D6/388
D. 380,880	7/1997	Reid	D30/161
D. 383,262	9/1997	Benwell	D30/161
D. 400,313	10/1998	Chatwell	D30/118
3,552,356	1/1971	Rosenthal	D30/118
3,890,931	6/1975	Saver	119/161
5,033,408	7/1991	Langenbahn	119/28.5
5,072,566	12/1991	Zeidman	D30/118

FIG. 8 is a side elevational view of FIG. 7;

FIG. 9 is a front elevational view of FIG. 7;

FIG. 10 is a rear elevational view of FIG. 7;

FIG. 11 is a top plan view of FIG. 7;

FIG. 12 is a bottom plan view of FIG. 7;

FIG. 13 is a perspective view of a third embodiment of FIG. 1;

FIG. 14 is a side elevational view of FIG. 13;

FIG. 15 is a front elevational view of FIG. 13; and,

FIG. 16 is a rear elevational view of FIG. 13;

FIG. 17 is a top pan view of FIG. 13; and,

FIG. 18 is a bottom plan view of FIG. 13.

1 Claim, 4 Drawing Sheets

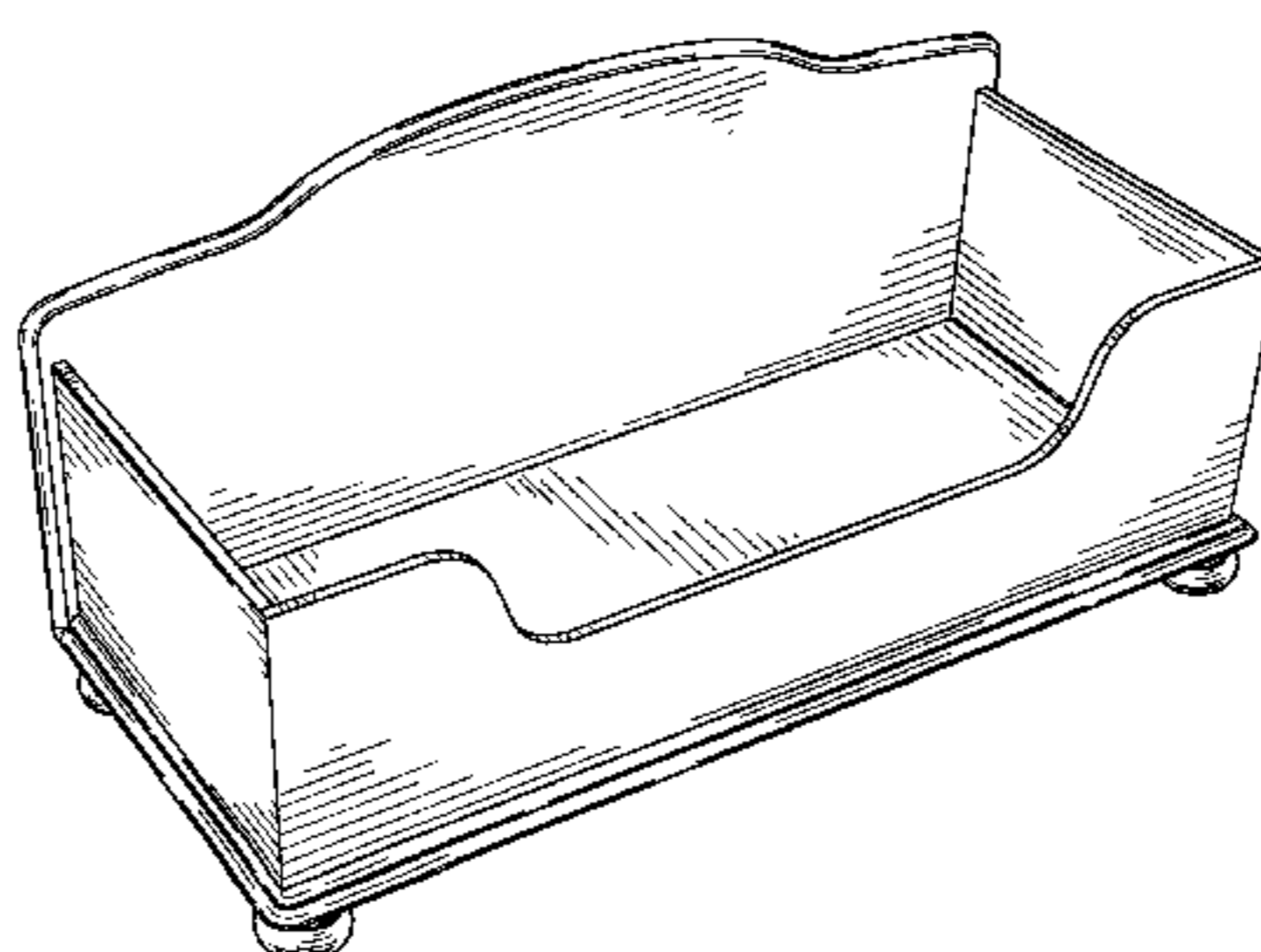
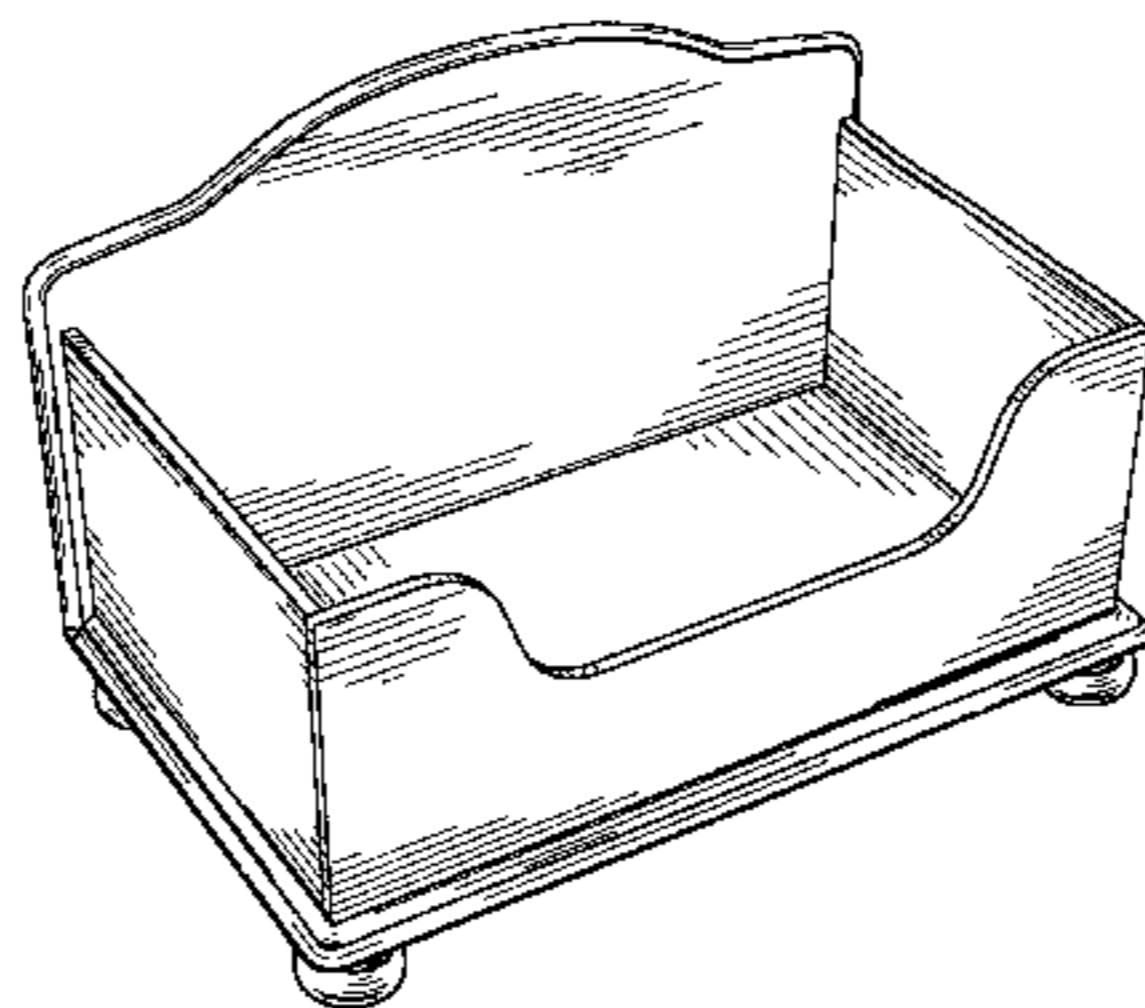
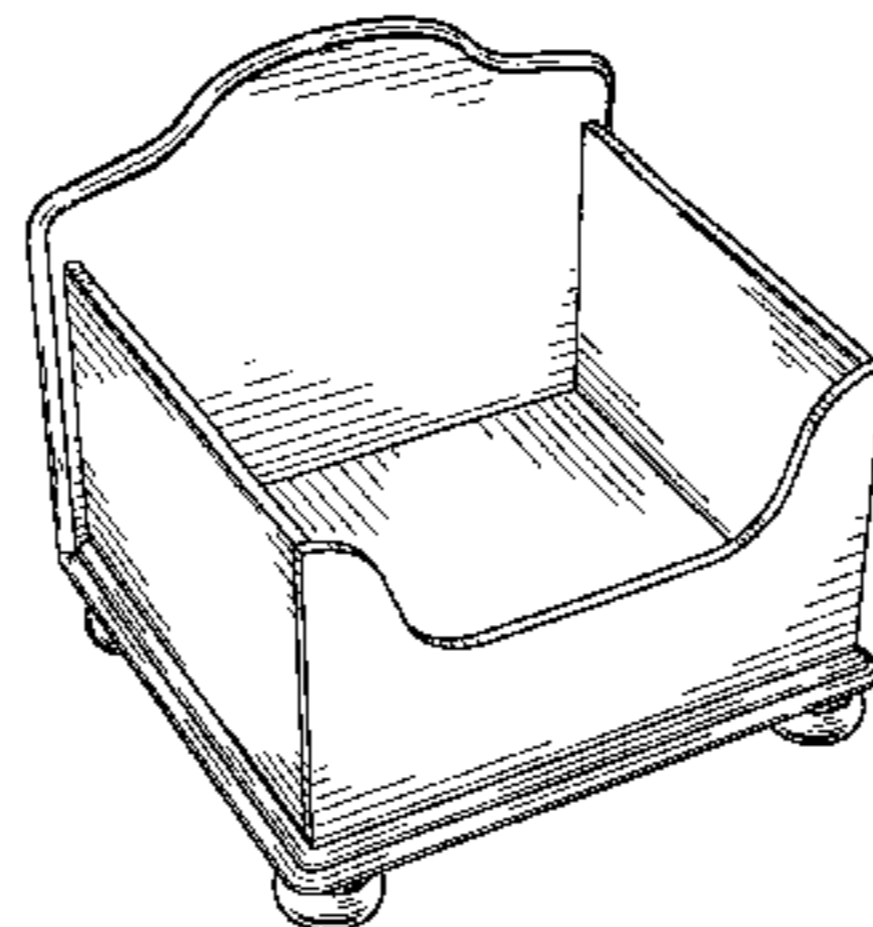

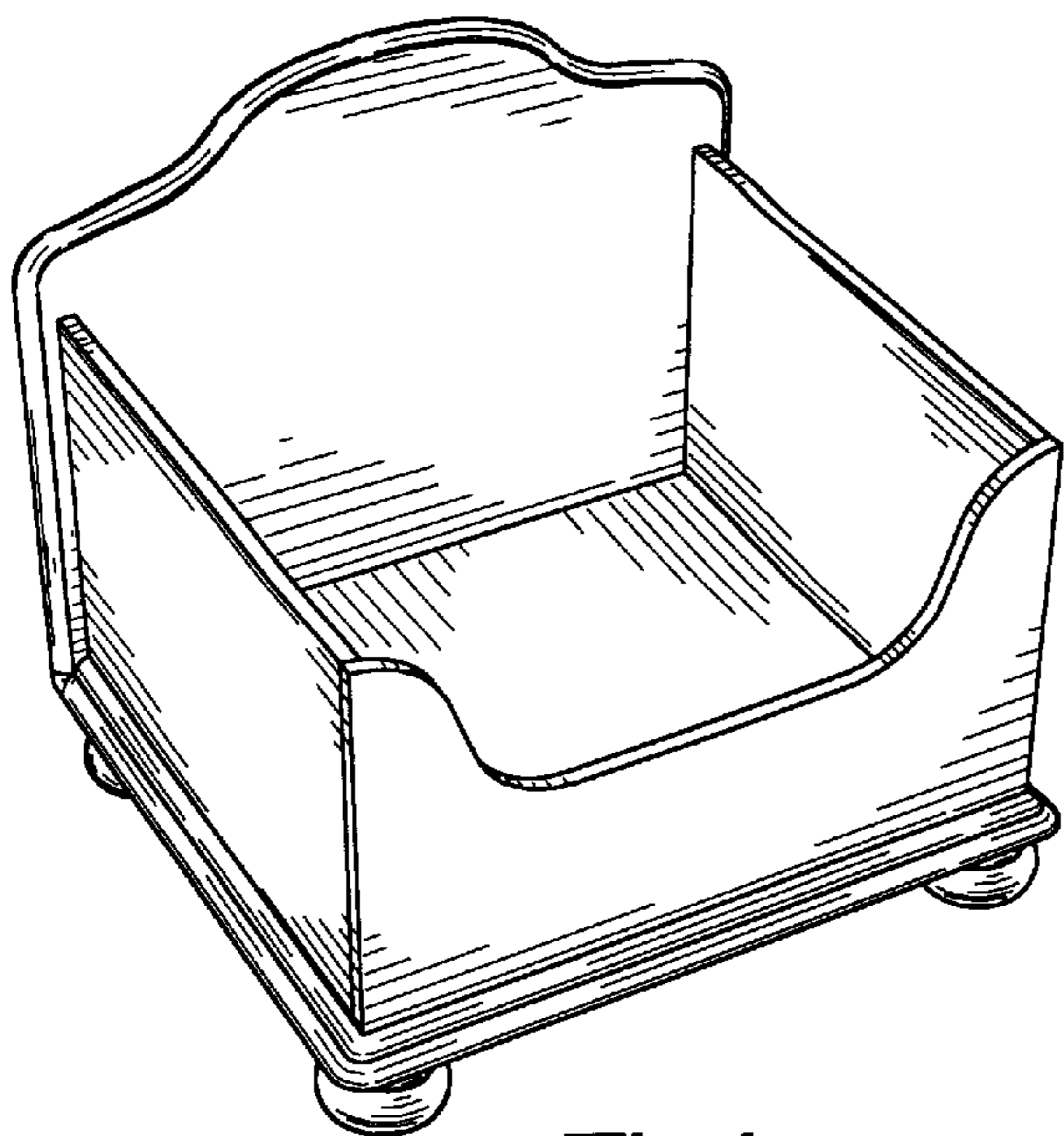

Fig.1

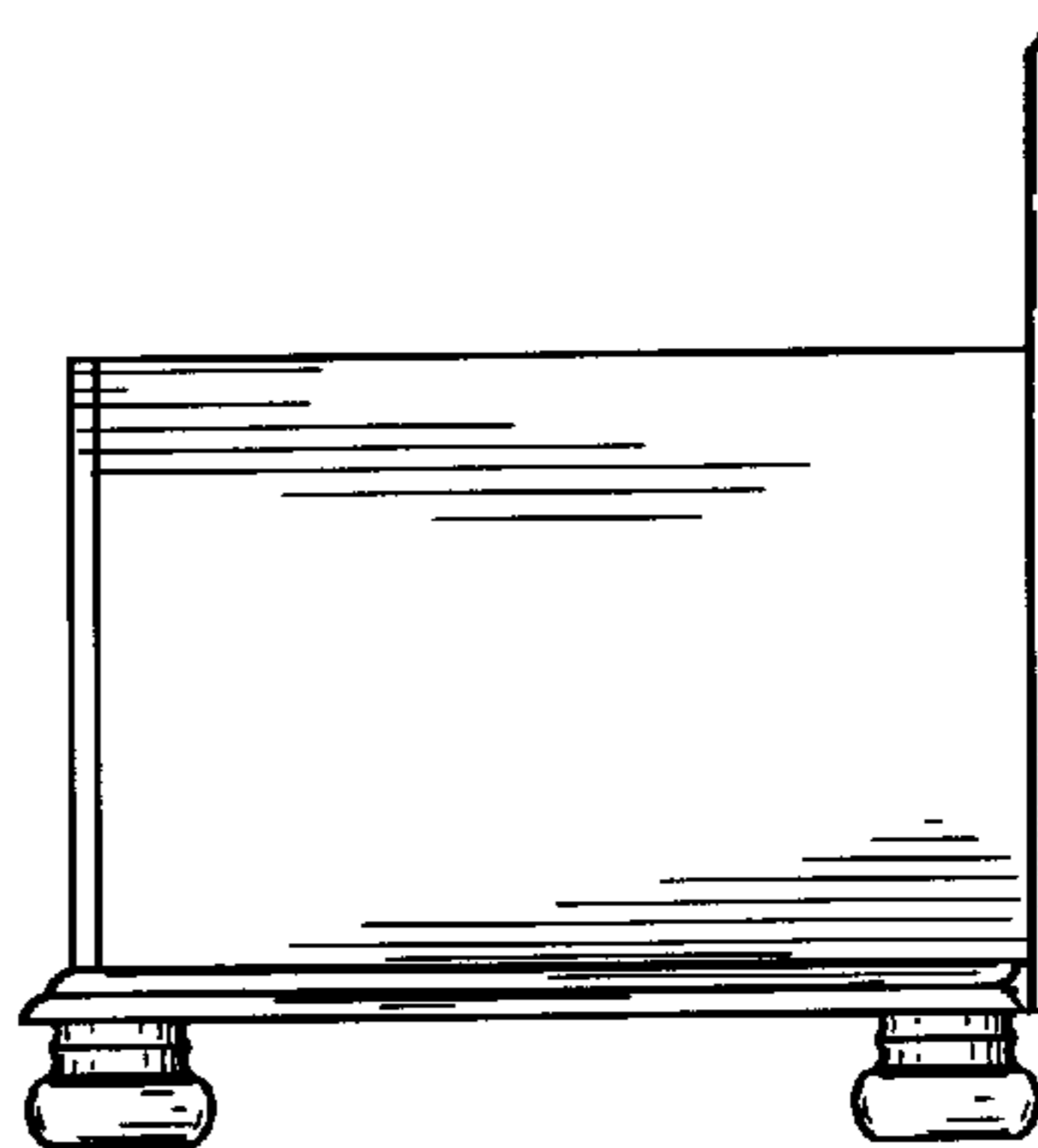

Fig.2

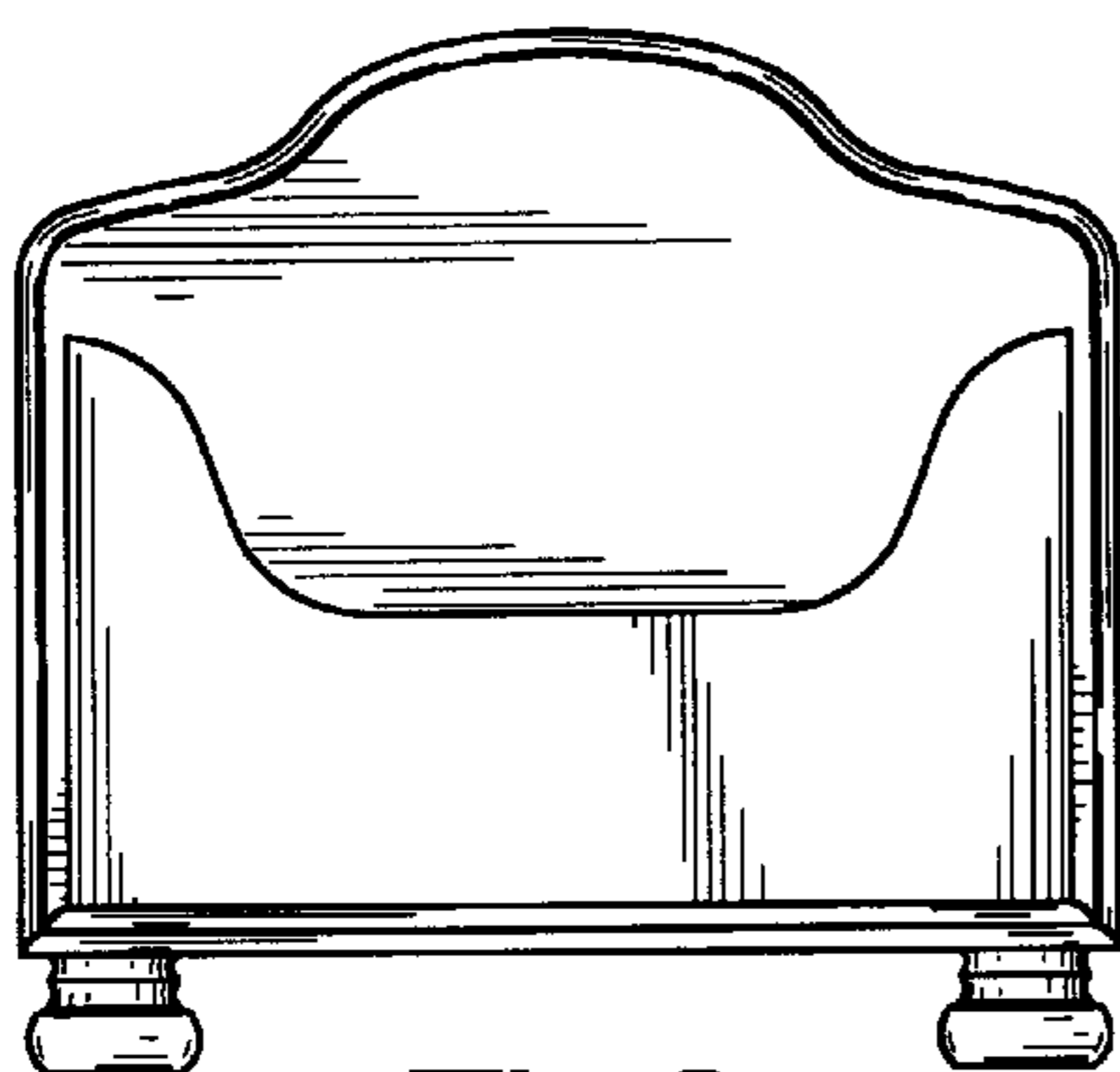

Fig.3

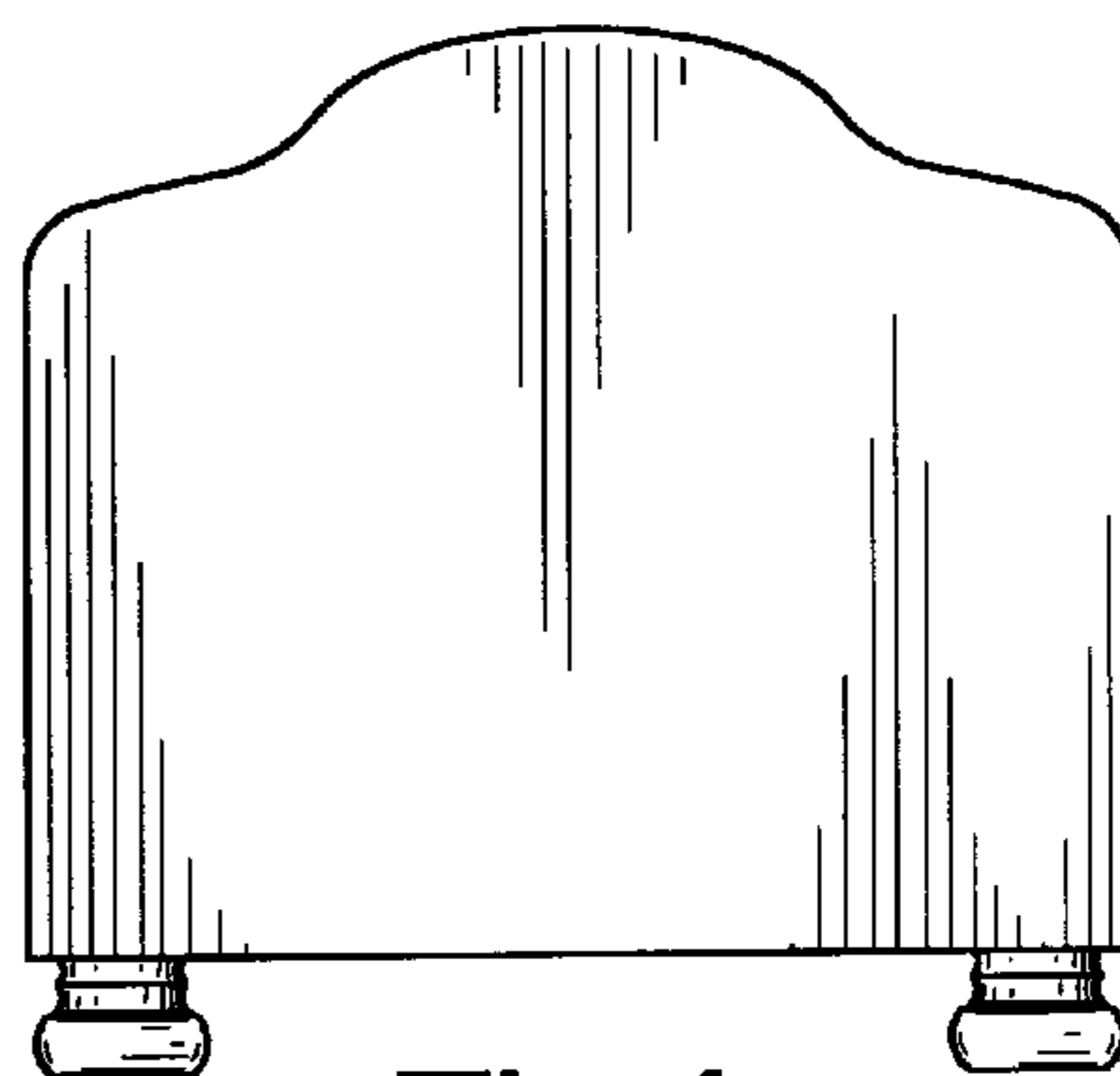

Fig.4

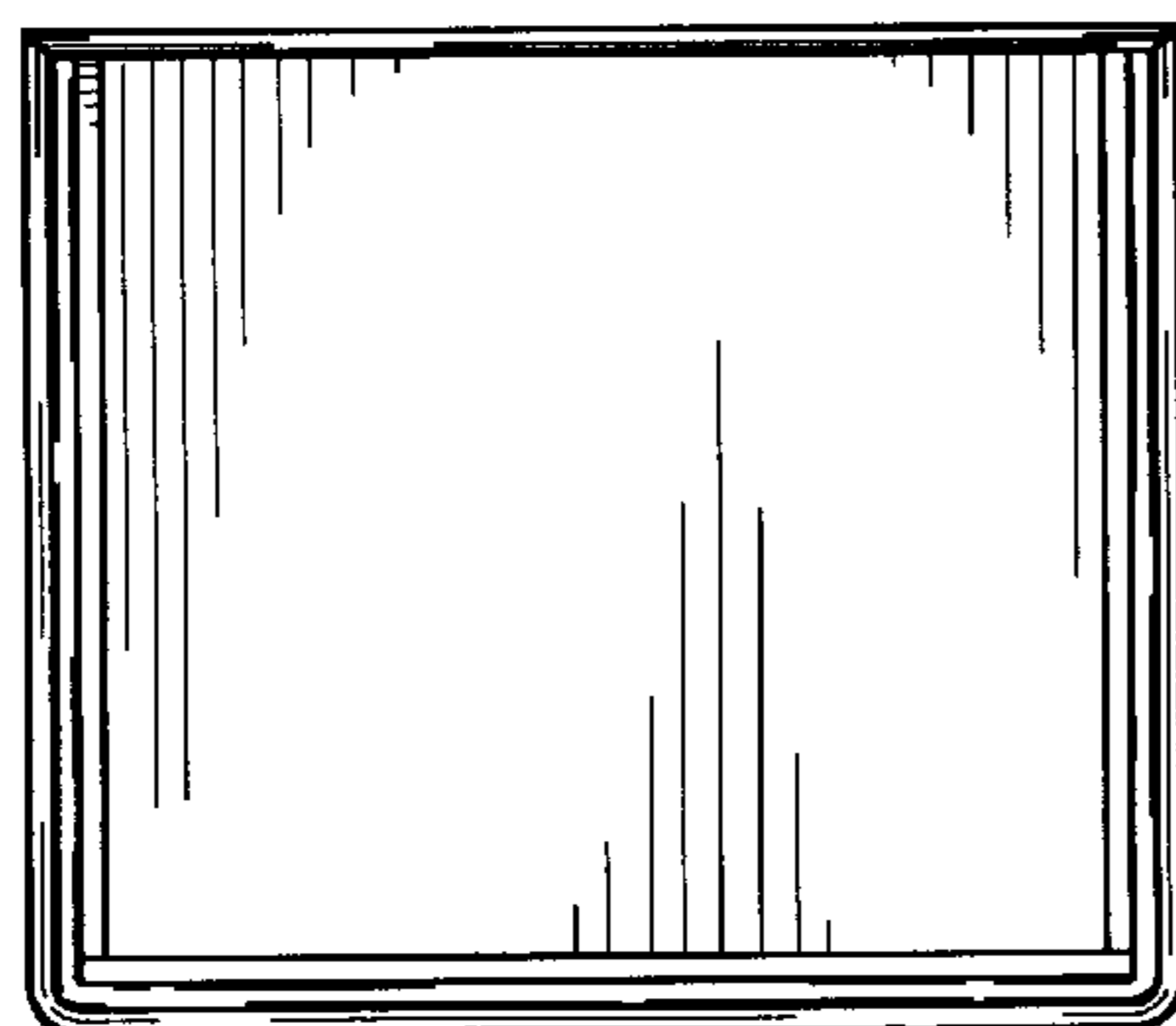

Fig.5

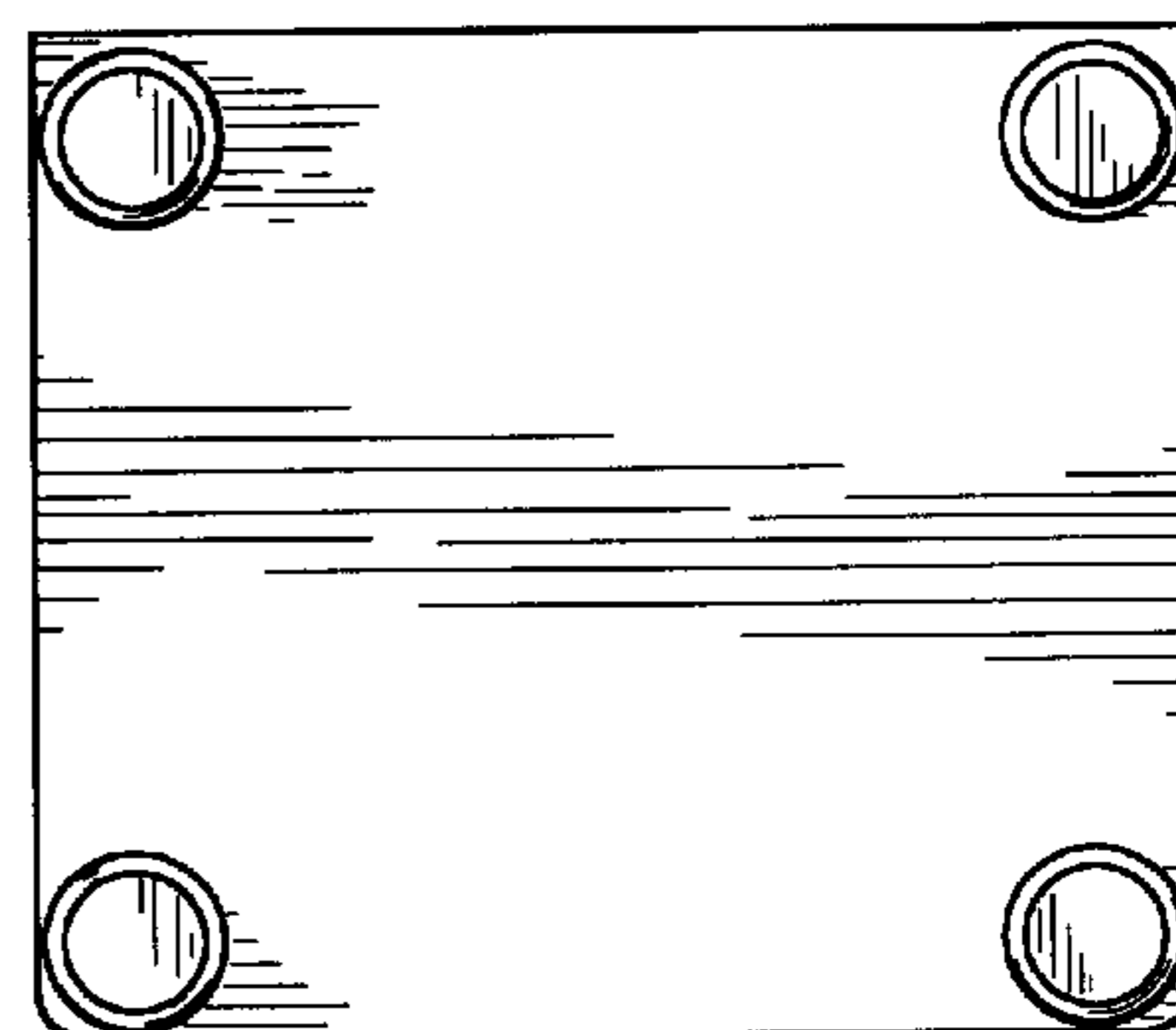

Fig.6

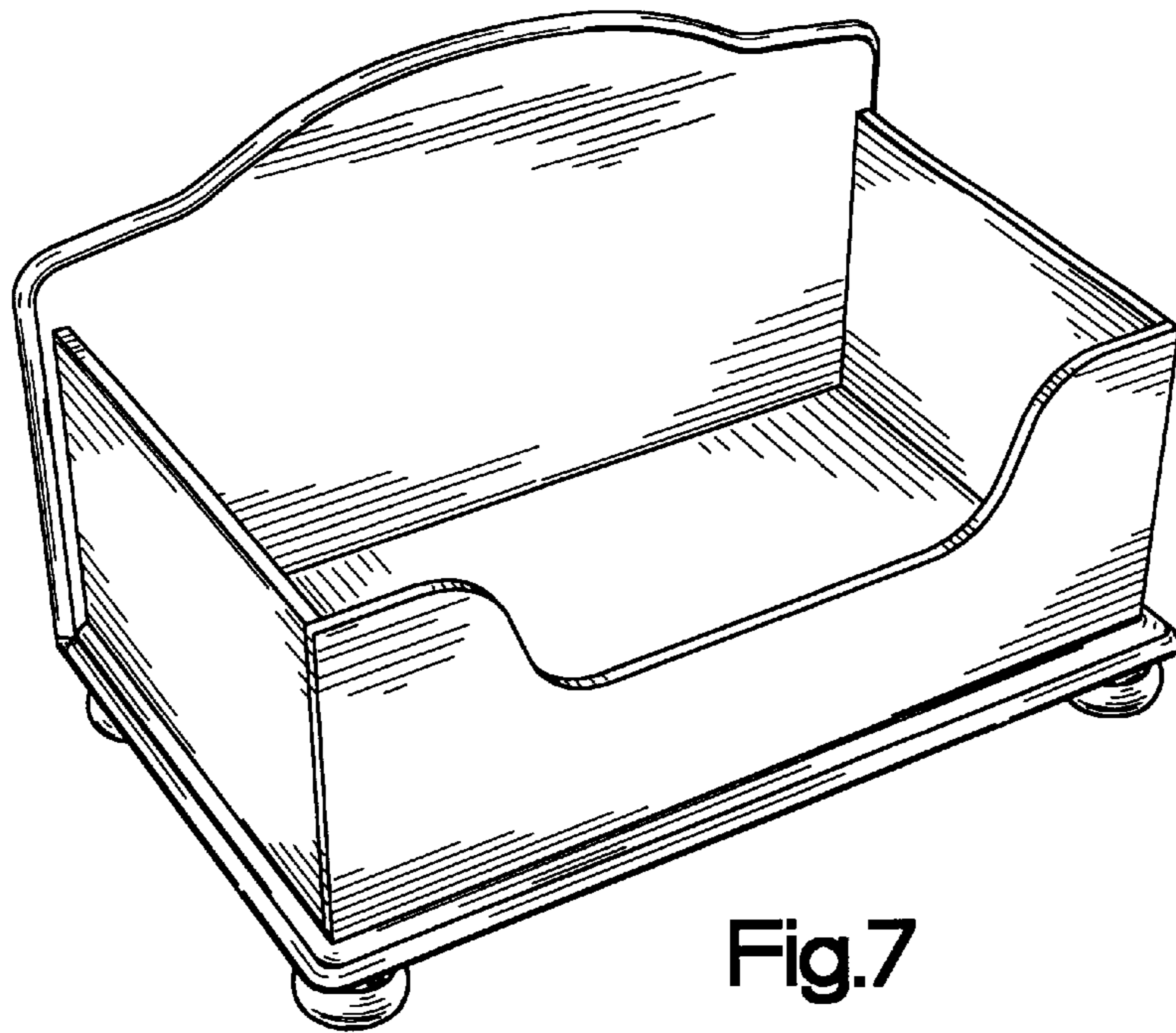

Fig.7

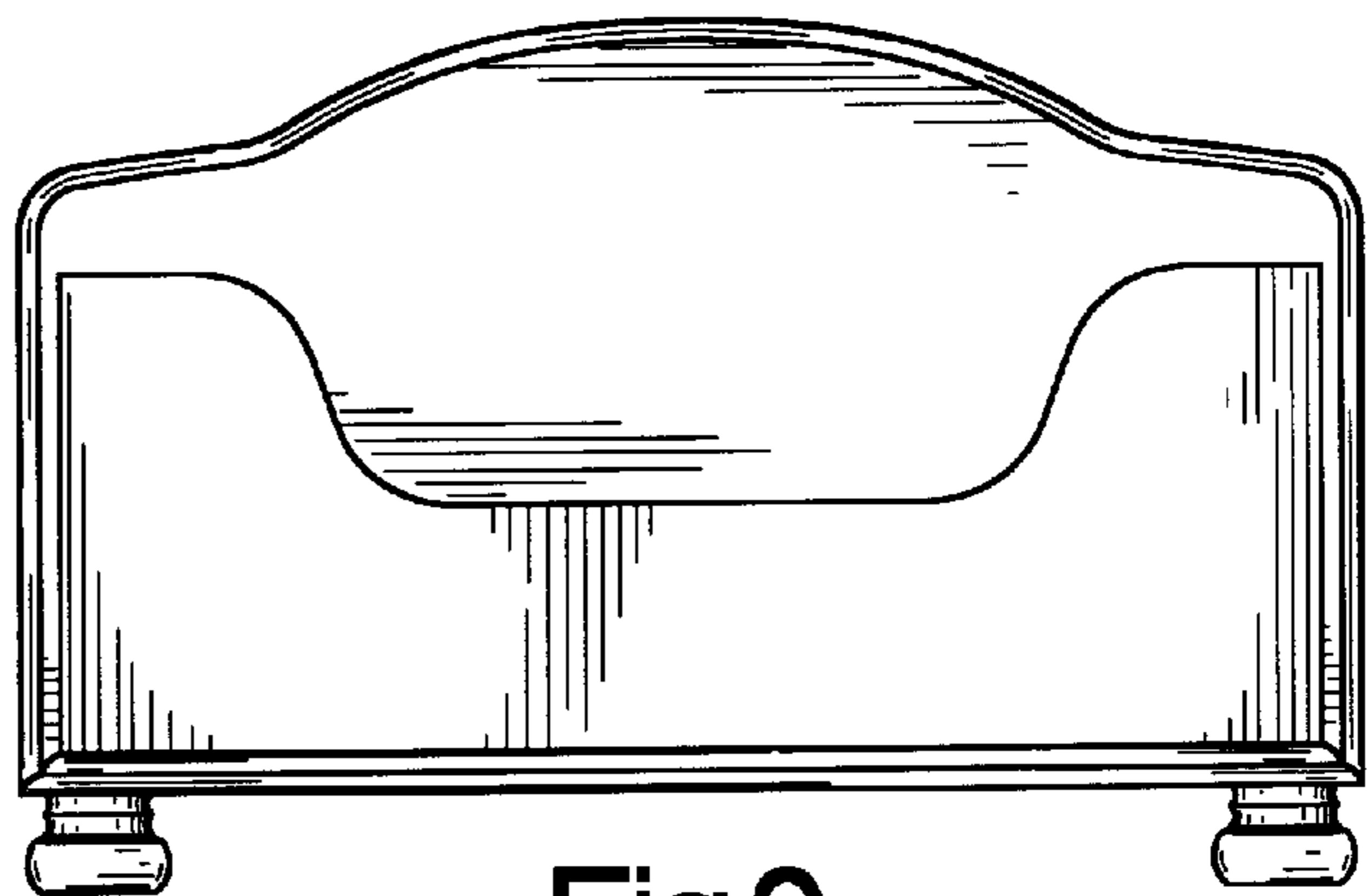

Fig.9

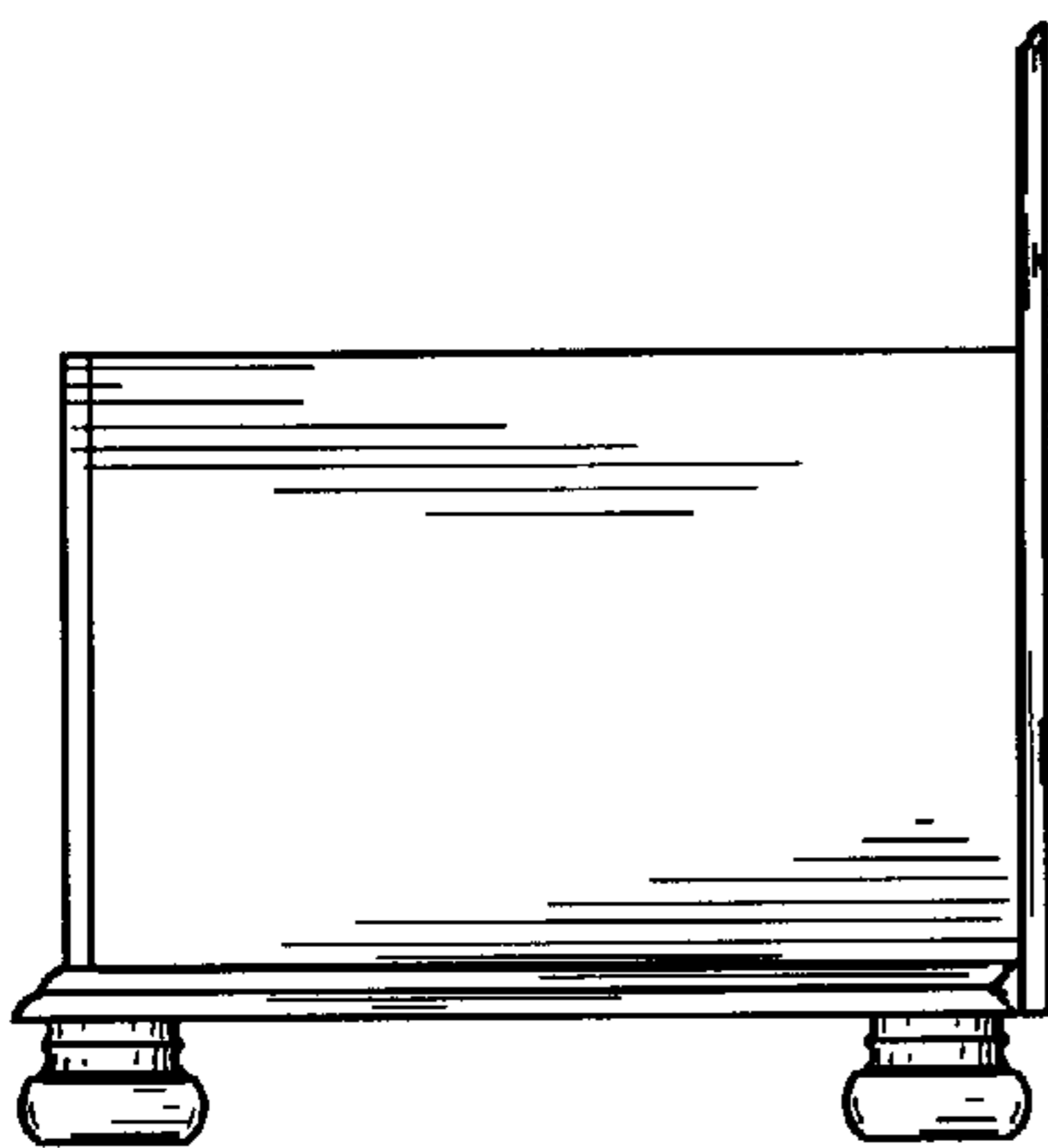

Fig.8

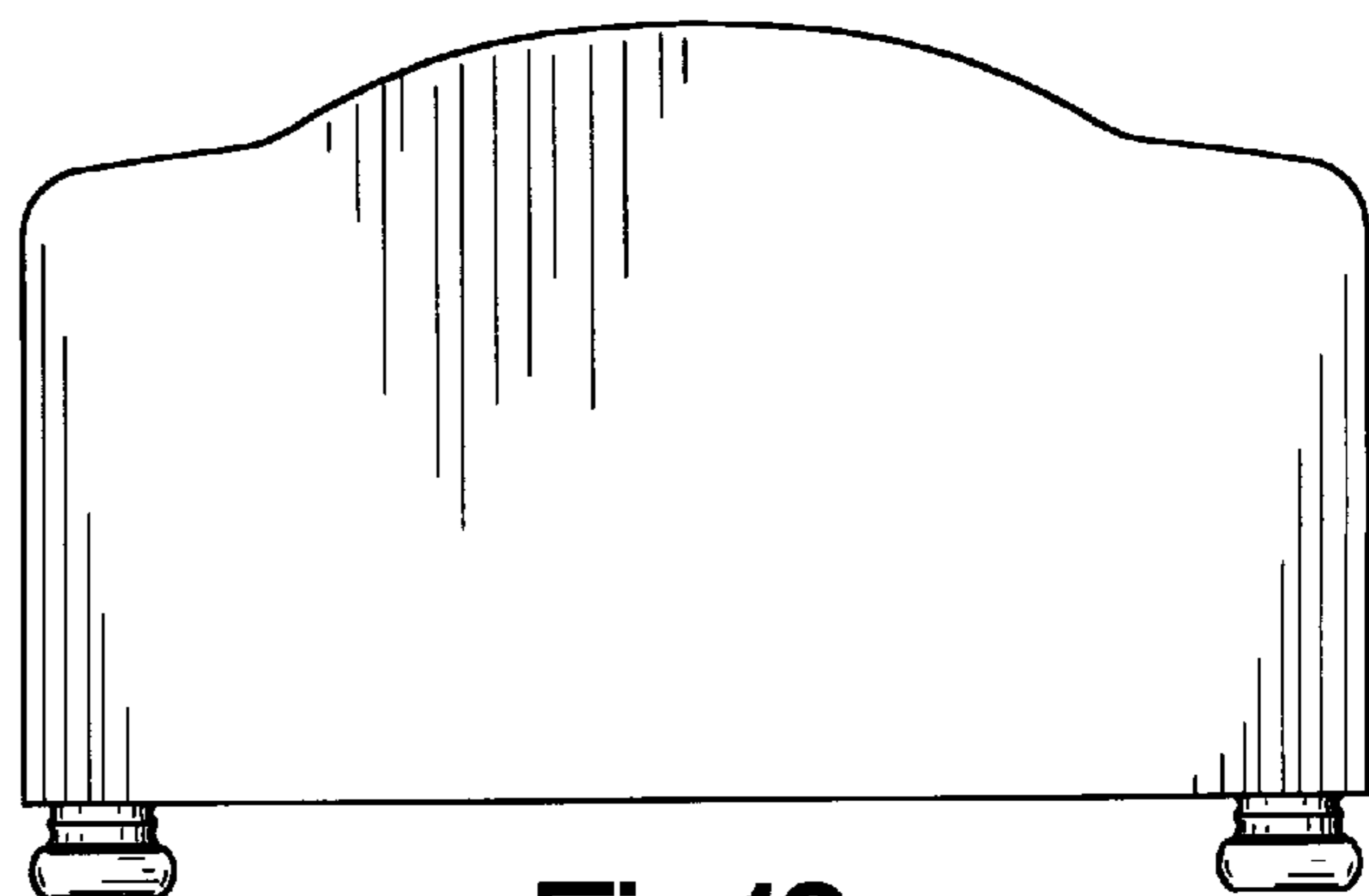

Fig.10

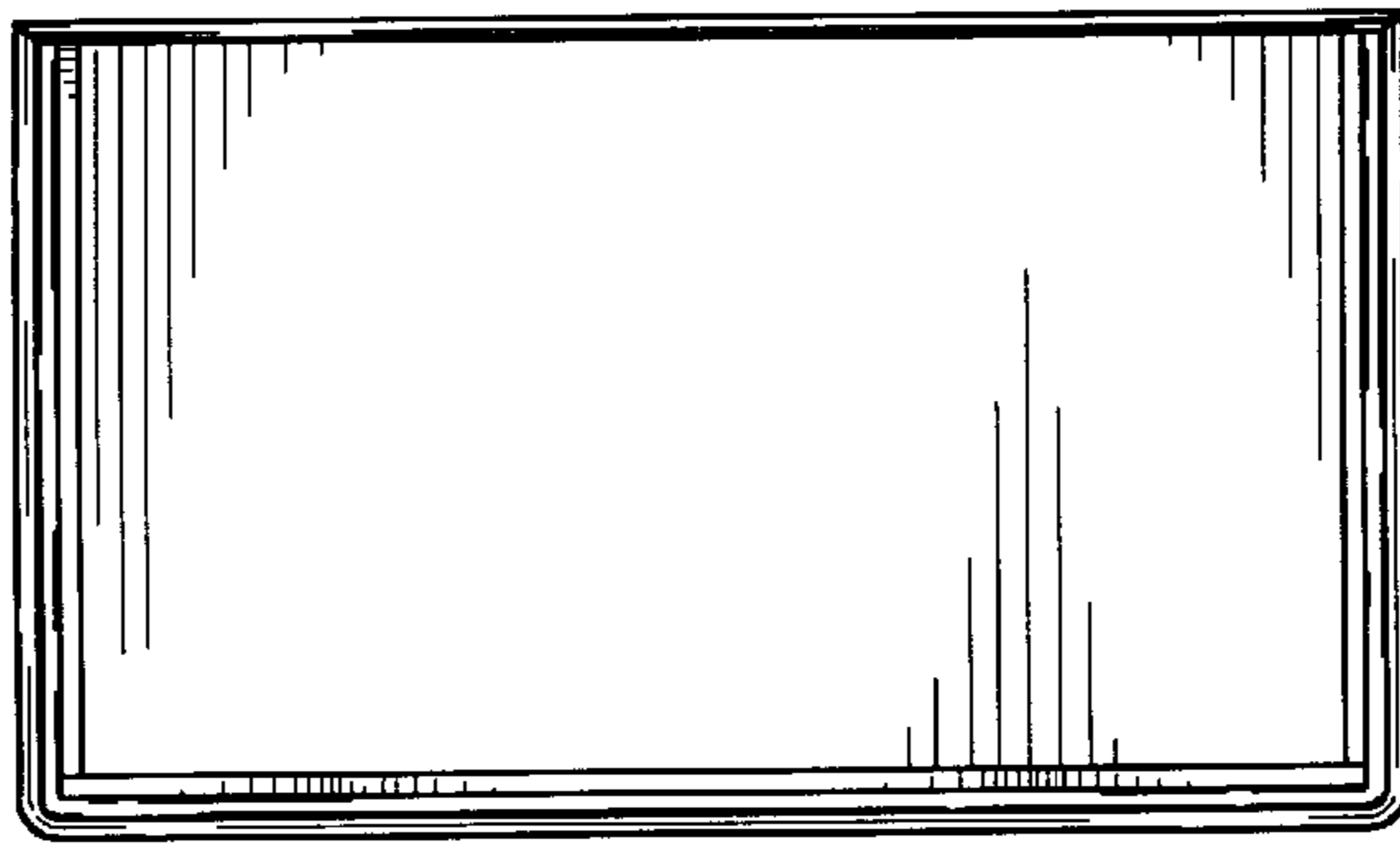

Fig.11

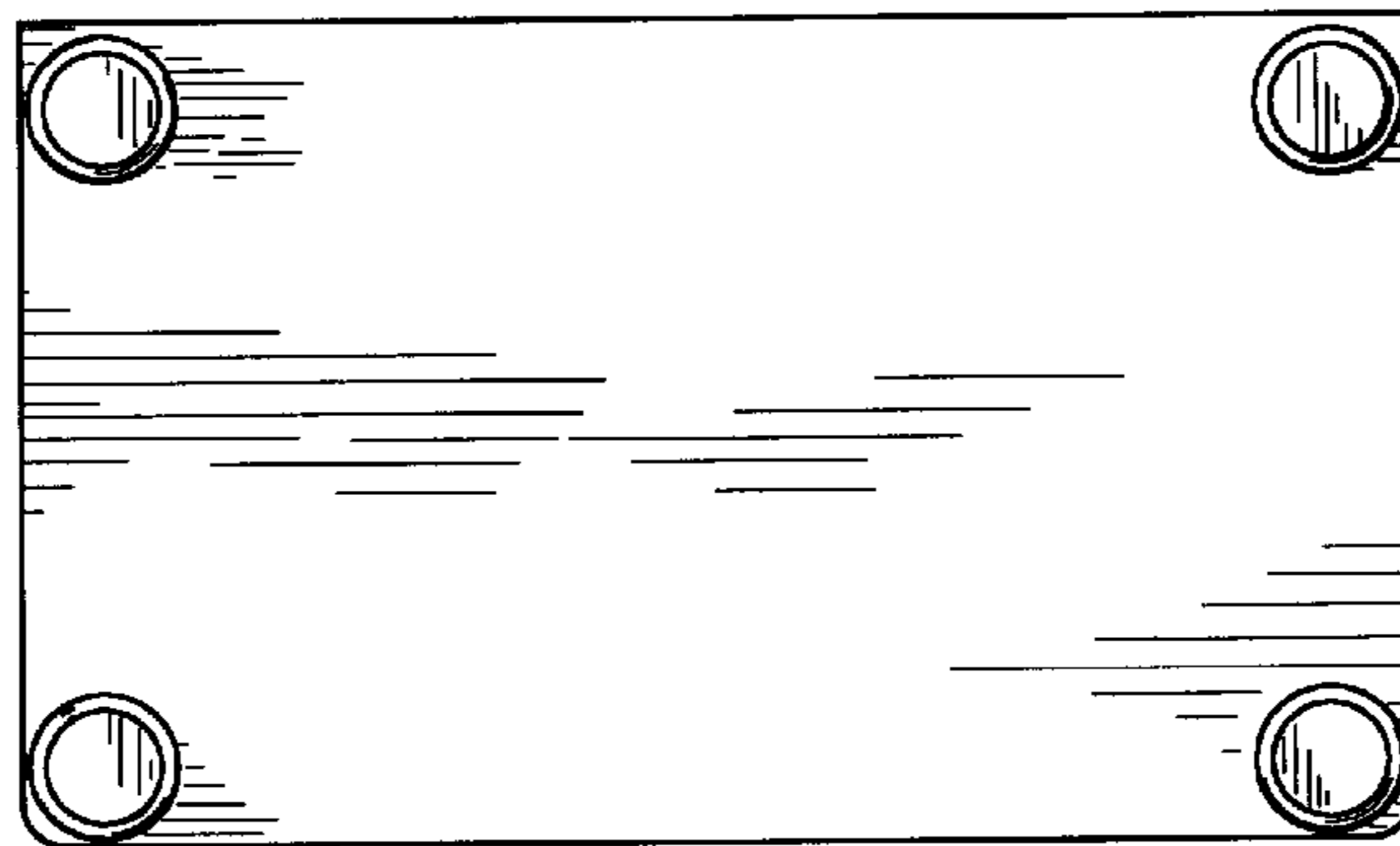

Fig.12

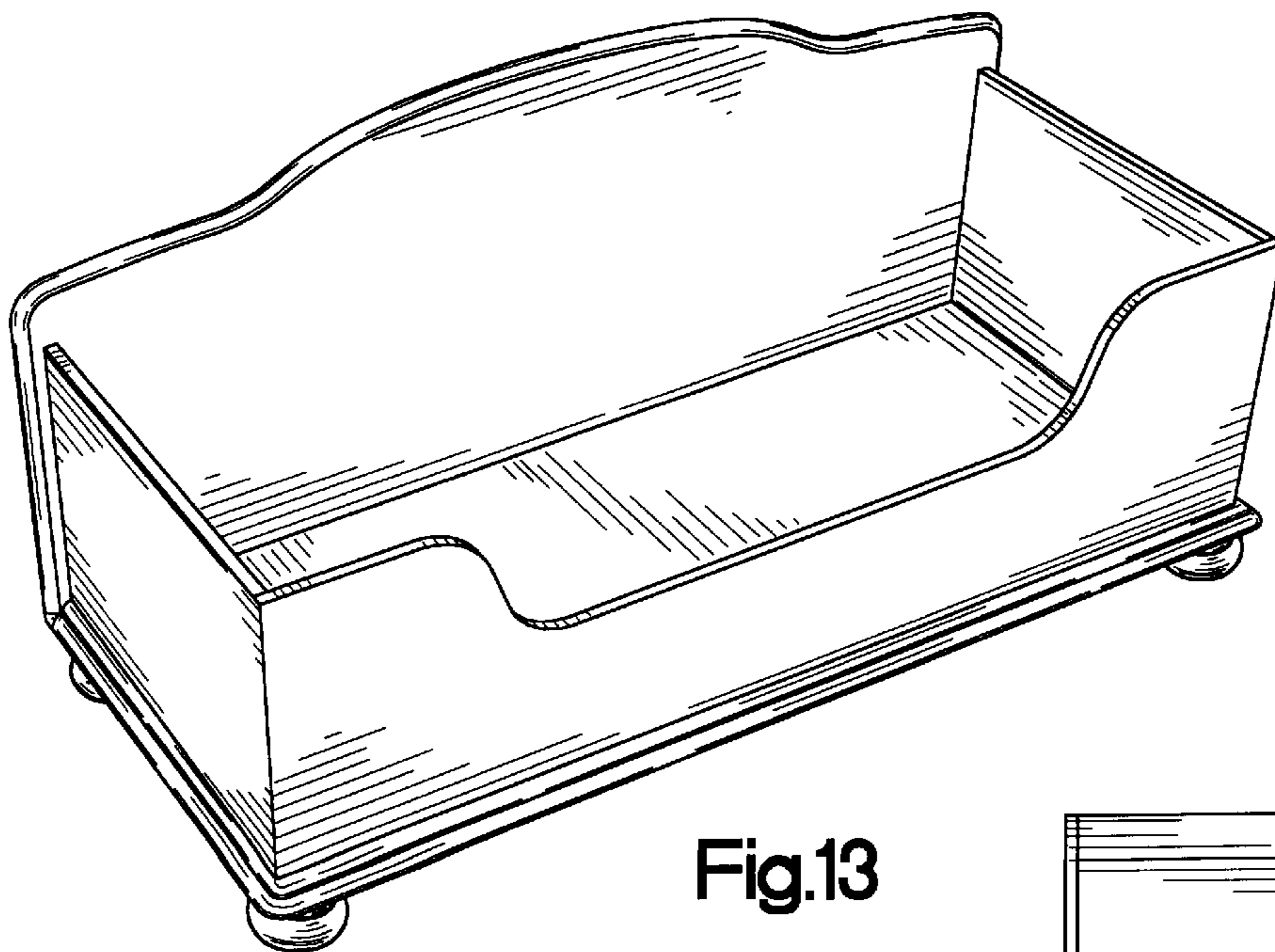

Fig.13

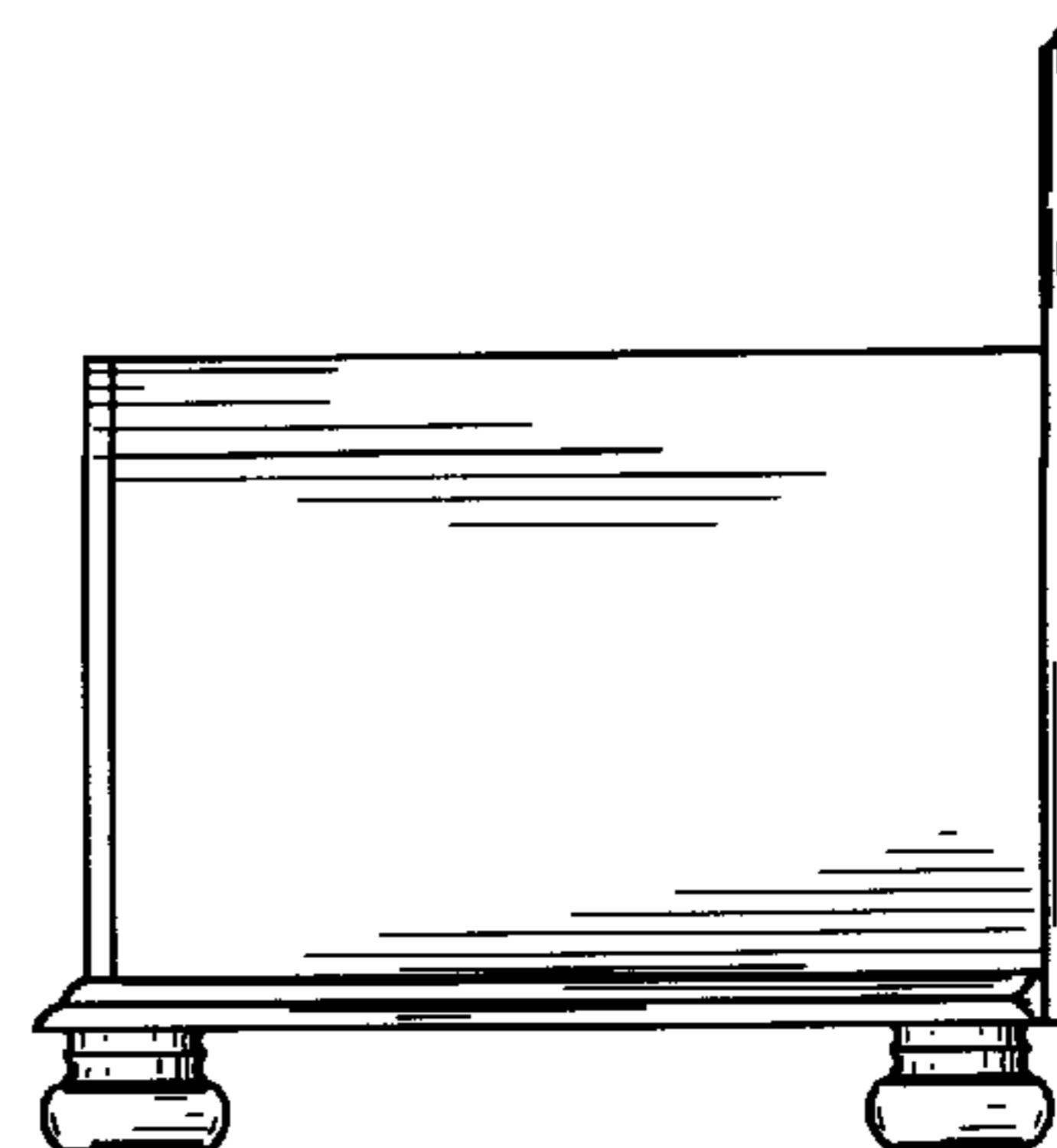

Fig.14

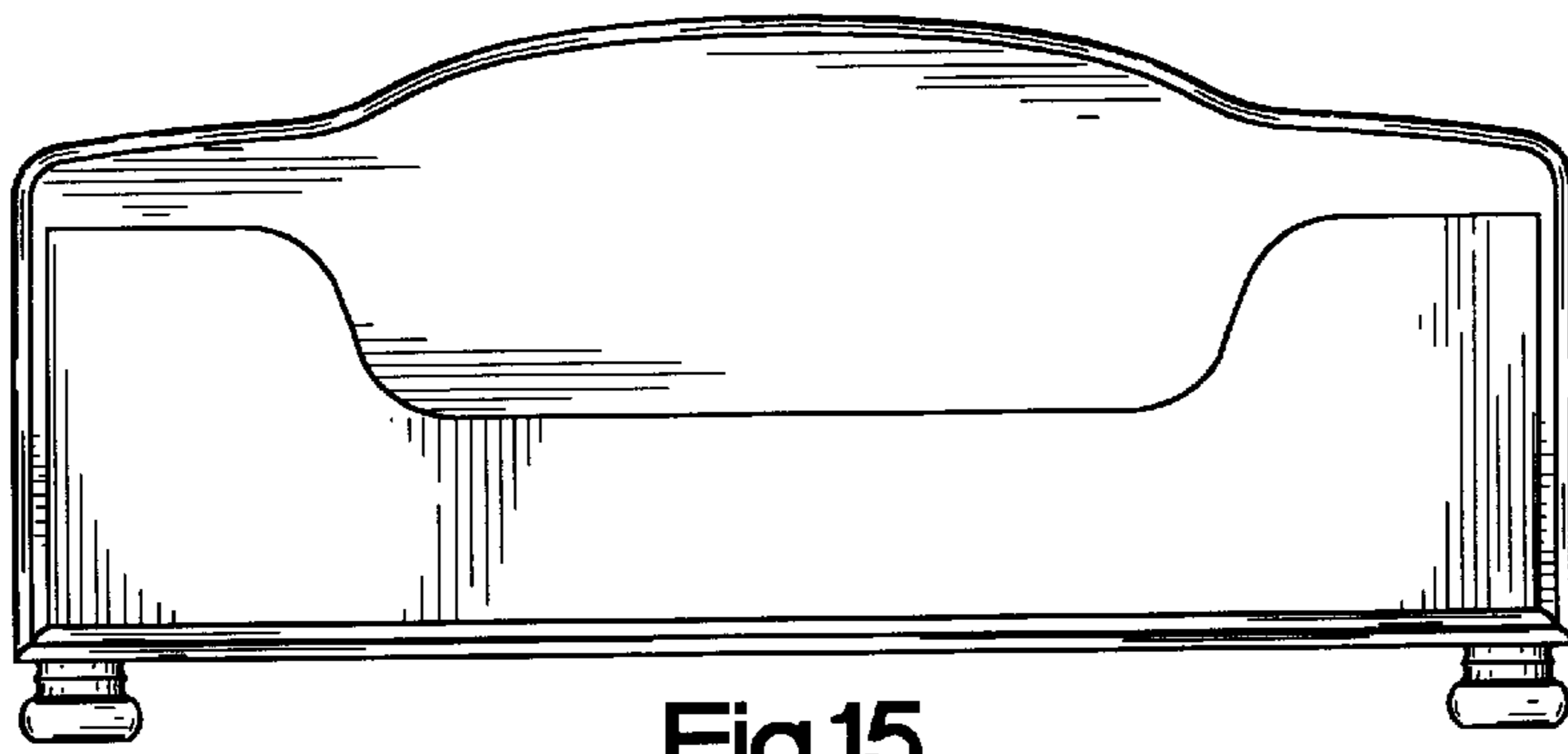

Fig.15

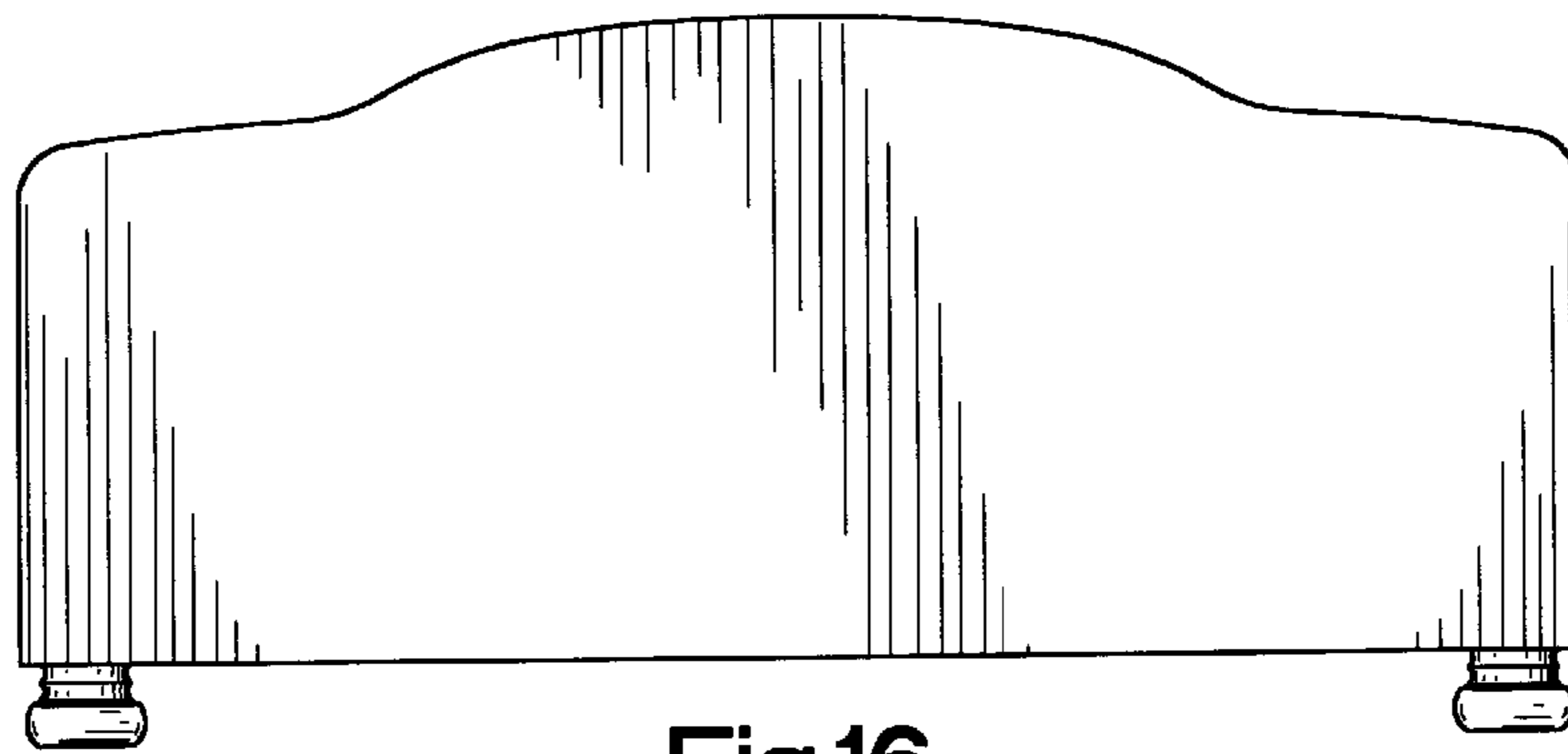

Fig.16

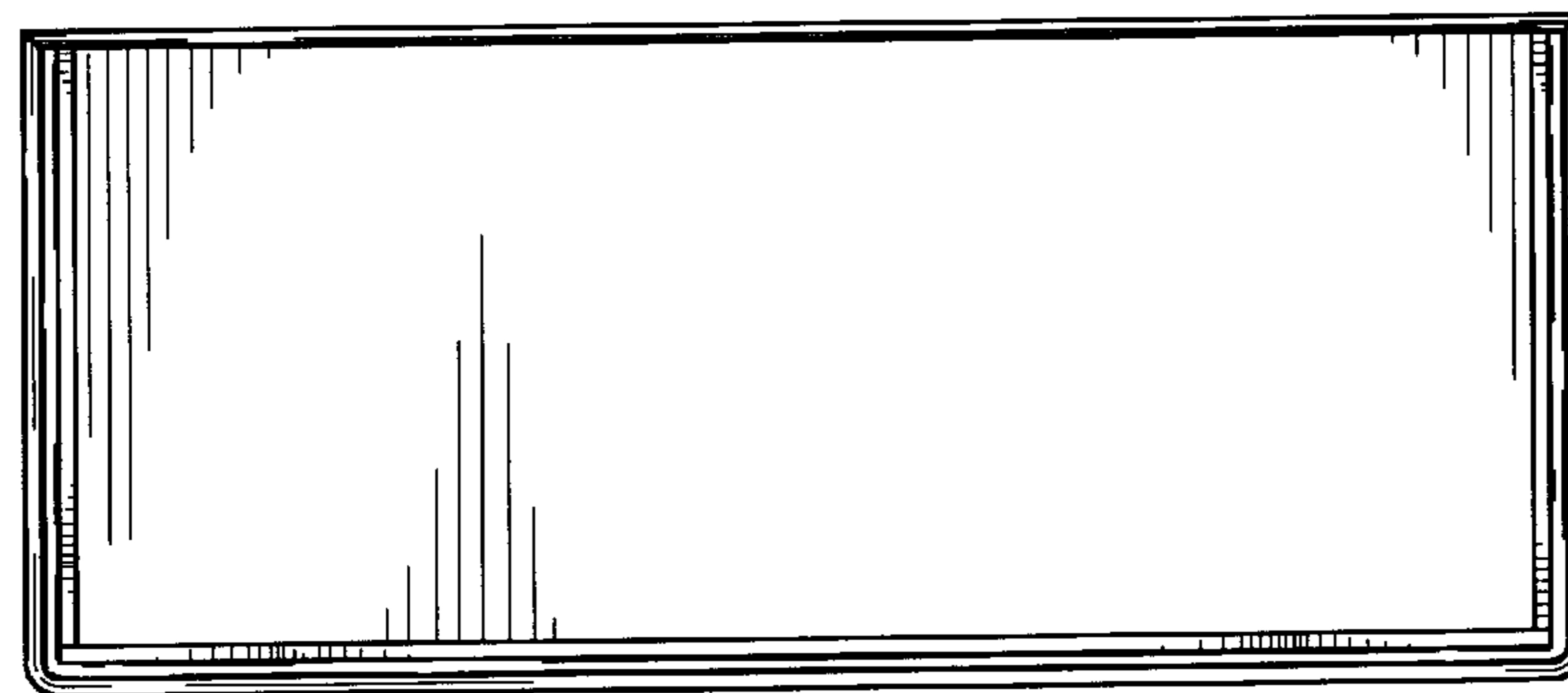

Fig.17

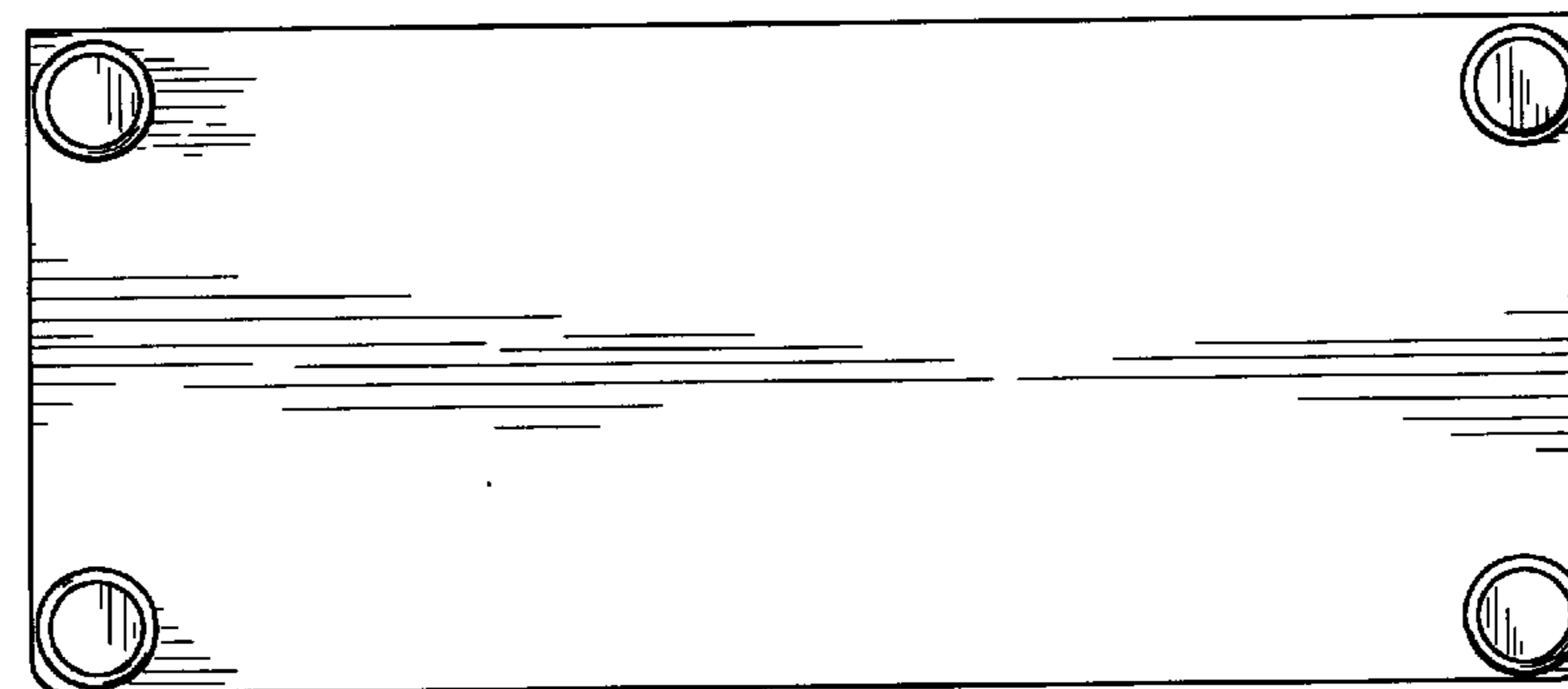

Fig.18