



US00D423489S

United States Patent [19]

Pesco

[11] **Patent Number: Des. 423,489**

[45] **Date of Patent: ** Apr. 25, 2000**

[54] **COMPUTER MOUSE**

[76] Inventor: **Jeanette Pesco**, 14 Union Pl., Northport, N.Y. 11768

[**] Term: **14 Years**

[21] Appl. No.: **29/107,016**

[22] Filed: **Jun. 24, 1999**

[51] **LOC (6) Cl. 14-02**

[52] **U.S. Cl. D14/117.3; D14/114**

[58] **Field of Search D14/100, 114, D14/117.1-117.9; D13/158; D21/385, 333; 200/5 R, 5 A, 6 R, 6 A; 273/148 B; 345/156-167; 463/36-39**

[56] **References Cited**

U.S. PATENT DOCUMENTS

- D. 331,229 11/1992 Pike .
- D. 331,575 12/1992 Pike .
- D. 343,392 1/1994 Harden et al. .
- D. 361,557 8/1995 Siano, Jr. .
- D. 361,558 8/1995 Siano, Jr. .
- D. 361,559 8/1995 Siano, Jr. .
- D. 369,154 4/1996 Powell .
- D. 369,219 4/1996 Huang .
- D. 370,219 5/1996 Blumer et al. .
- D. 374,219 10/1996 Allana et al. .
- D. 378,516 3/1997 Smith et al. .
- D. 380,210 6/1997 Allana et al. .

- D. 381,015 7/1997 Morrison et al. .
- D. 386,160 11/1997 Young .
- D. 386,161 11/1997 Young .
- D. 387,338 12/1997 Leifer .
- D. 387,748 12/1997 Martella .
- 5,570,112 10/1996 Robinson .
- 5,692,956 12/1997 Rifkin .
- 5,696,536 12/1997 Murphy .

Primary Examiner—Kay H. Chin
Attorney, Agent, or Firm—Galvano & Burke

[57] **CLAIM**

The ornamental design for a computer mouse, as shown and described.

DESCRIPTION

FIG. 1 is a perspective view of a computer mouse showing my new design;
 FIG. 2 is a top plan view thereof;
 FIG. 3 is a bottom plan view thereof;
 FIG. 4 is a left side elevational view thereof, the right side view being a mirror image of that shown;
 FIG. 5 is a front elevational view thereof;
 FIG. 6 is a rear elevational view thereof;
 FIG. 7 is a top plan view of a second embodiment of the computer mouse; and,
 FIG. 8 is a top plan view of a third embodiment of the computer mouse.

1 Claim, 4 Drawing Sheets

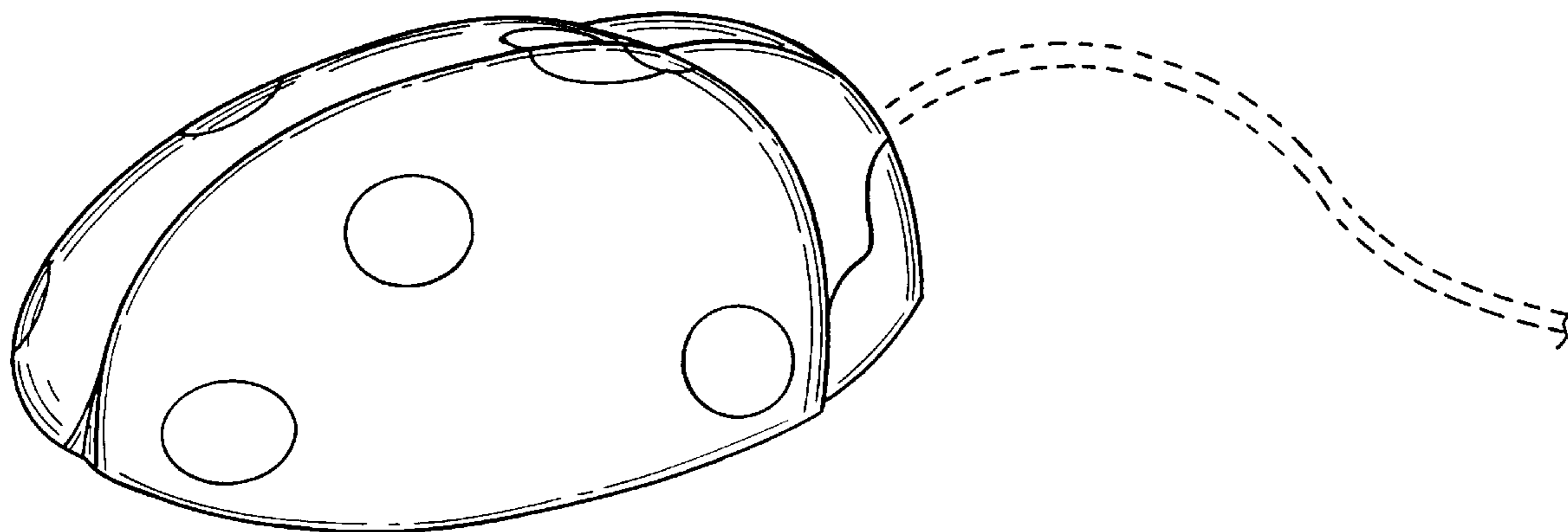

FIG. 1

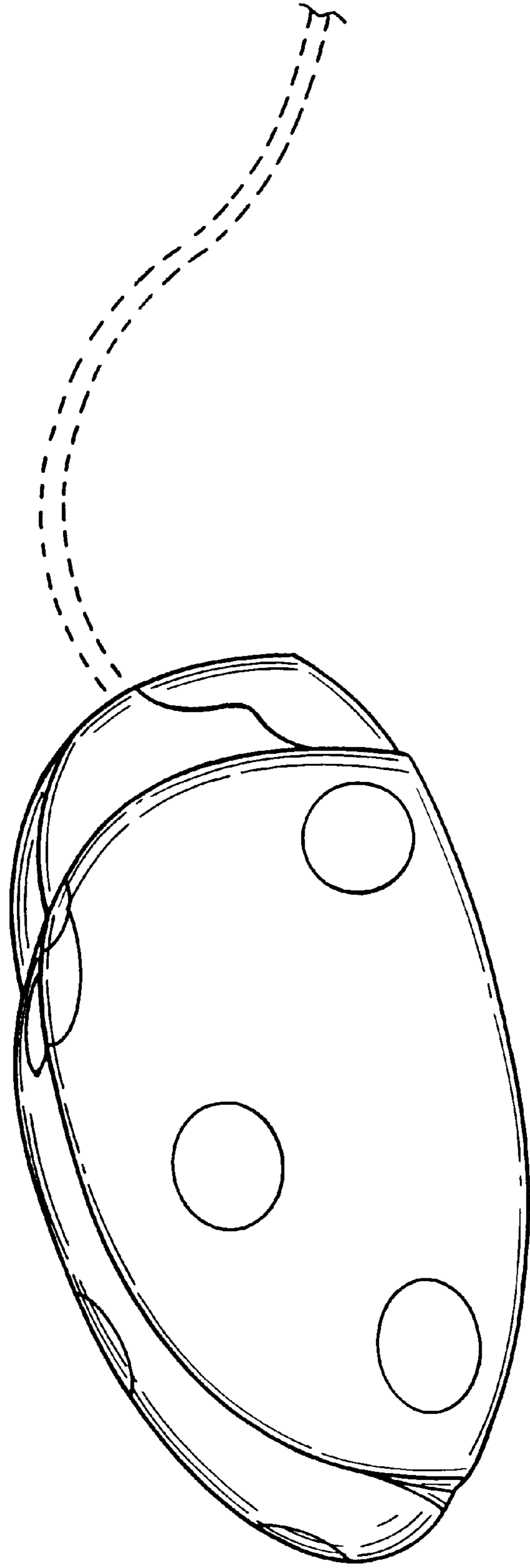

FIG. 3

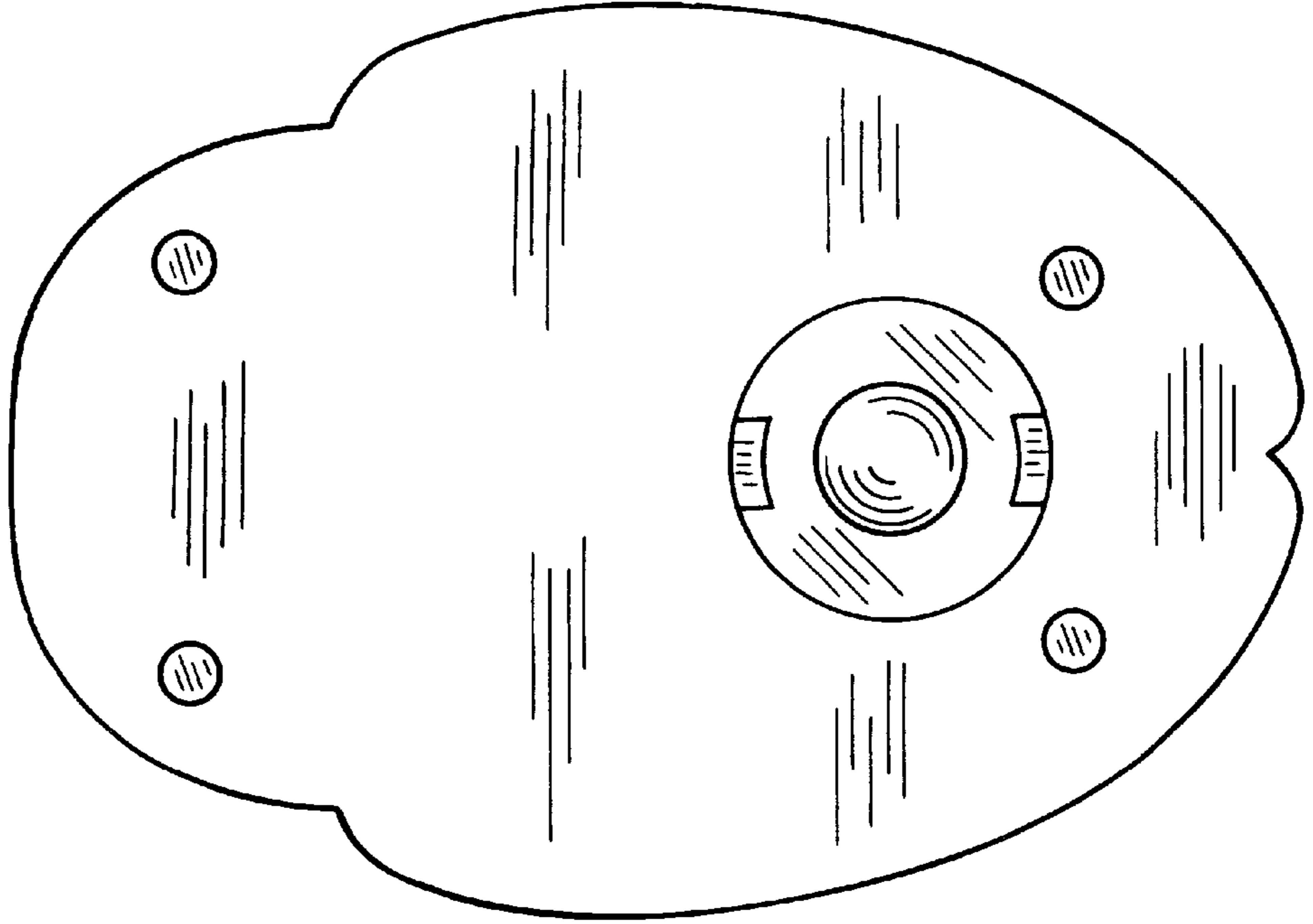

FIG. 2

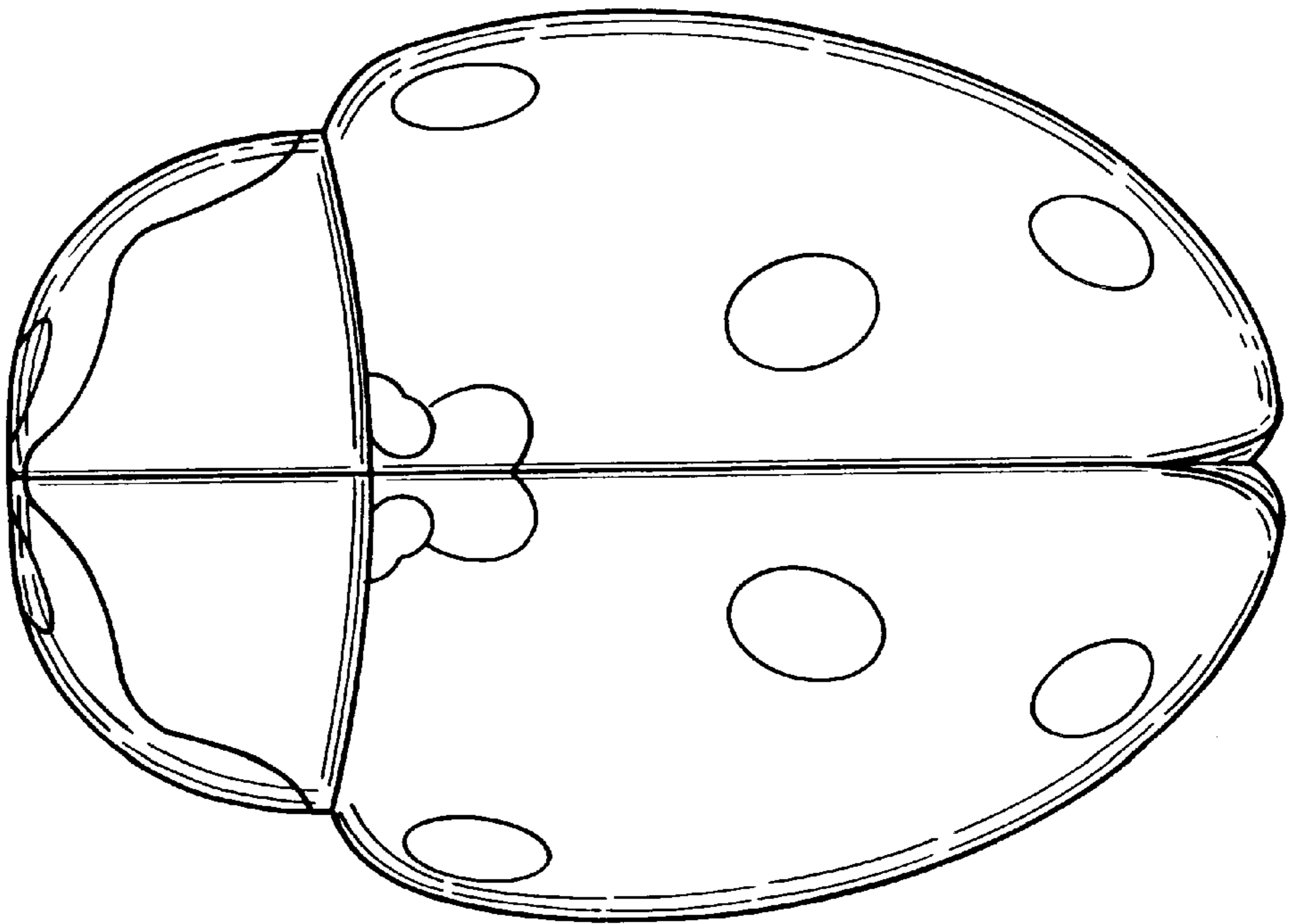

FIG. 4

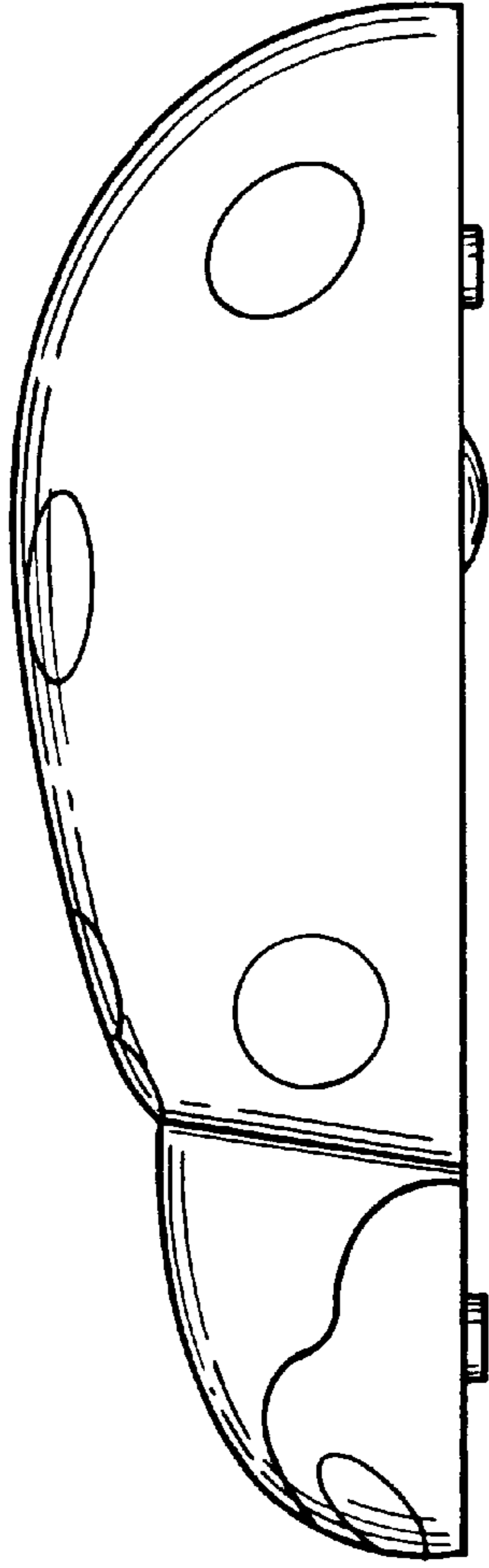

FIG. 5

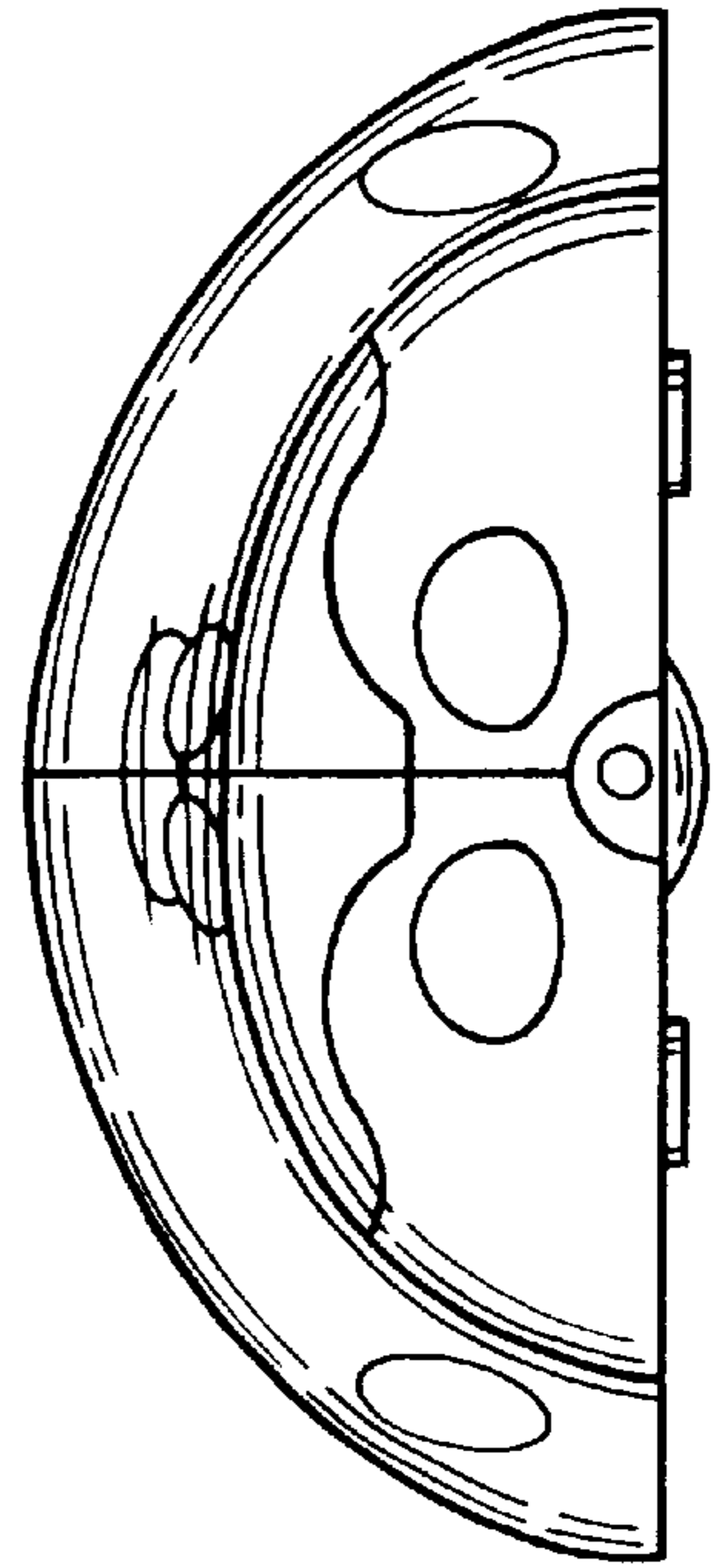

FIG. 6

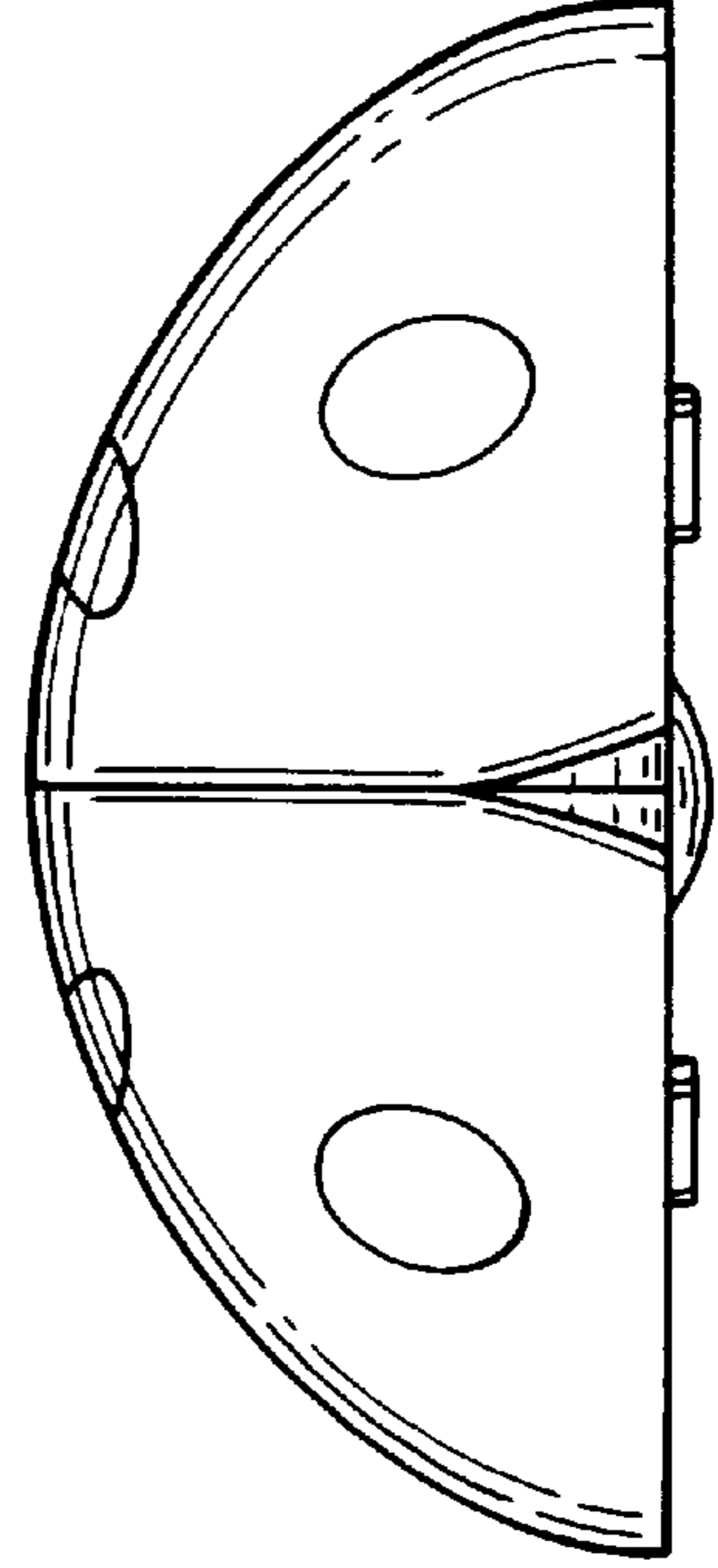

FIG. 8

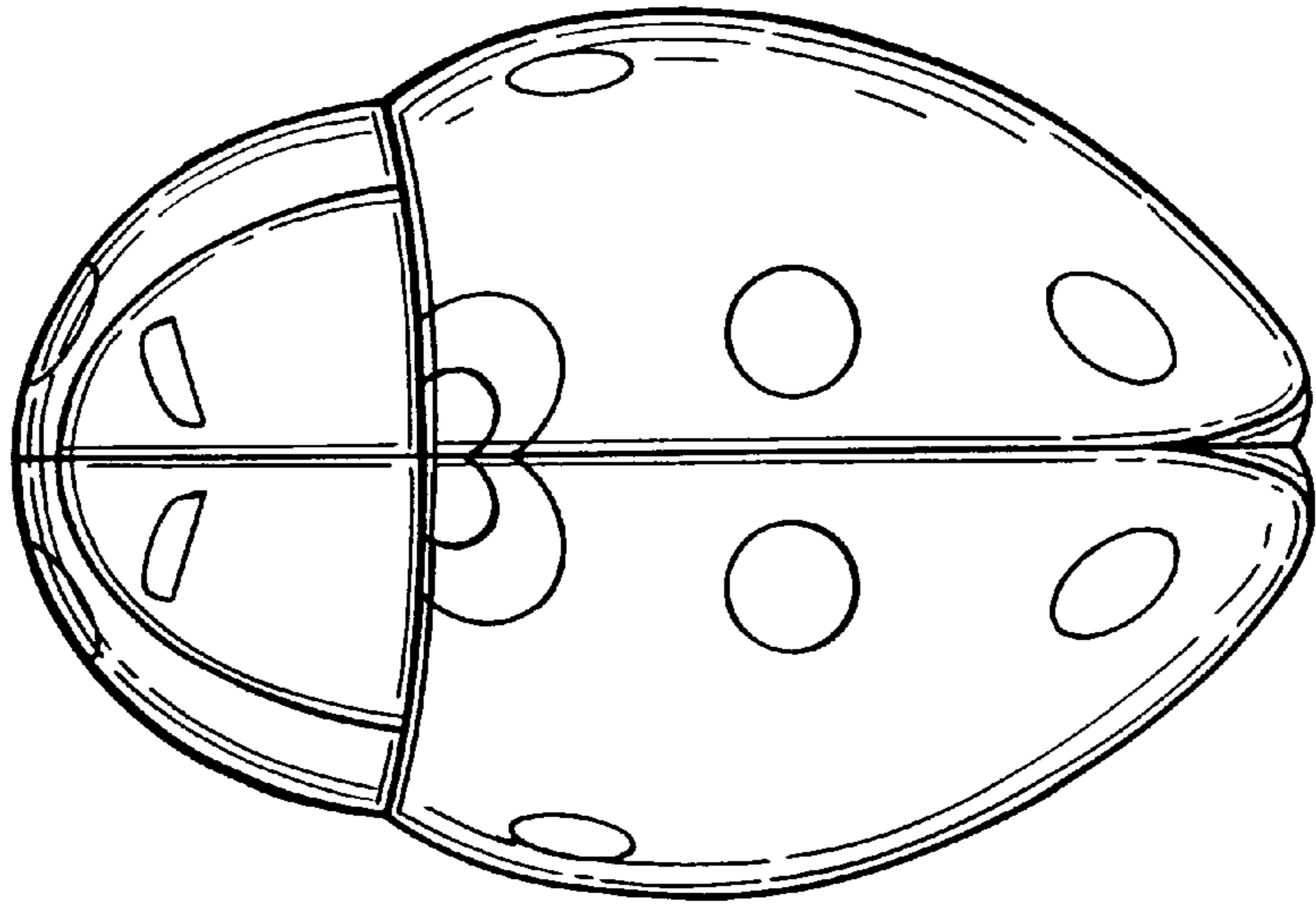

FIG. 7

