



US00D423402S

United States Patent [19]

[11] **Patent Number: Des. 423,402**

Landry

[45] **Date of Patent: ** Apr. 25, 2000**

- [54] **DECORATIVE STONE ARTICLE**
- [75] Inventor: **Curtis E. Landry**, Siloam Springs, Ark.
- [73] Assignee: **One In Christ Jesus, Inc.**, Springdale, Ark.
- [**] Term: **14 Years**
- [21] Appl. No.: **29/101,208**
- [22] Filed: **Feb. 26, 1999**
- [51] **LOC (6) Cl.** **11-02**
- [52] **U.S. Cl.** **D11/132**
- [58] **Field of Search** D11/131, 132, D11/133; D20/10, 29; D25/138, 145; 428/913.3

Time Is Money, Rauzist Photomask, Inc., Vista, California 92083, Sep., 1998.
 What is Sandcarving? How is it Achieved?, Rayzist Photomask, Inc., Vista, California 92083, Sep., 1998.
 Dimensional Stone Stats, Dimensional Stone, Sep. 15, 1998, pp. 20-21.

Primary Examiner—Dominic Simone
Attorney, Agent, or Firm—Head, Johnson & Kachigian

[57] CLAIM

The ornamental design for a decorative stone article, as shown and described.

DESCRIPTION

FIG. 1 is a front perspective view of one embodiment of a decorative stone article showing my new design;
 FIG. 2 is an enlarged perspective view of the lower corner of the decorative stone article of FIG. 1;
 FIG. 3 is a rear perspective view of the decorative stone article;
 FIG. 4 is a front view thereof;
 FIG. 5 is a right side view thereof;
 FIG. 6 is a rear view thereof; and,
 FIG. 7 is a top view thereof.

- [56] **References Cited**
- U.S. PATENT DOCUMENTS
- D. 88,744 12/1932 Benduce D11/132
- D. 369,573 5/1996 Sorce D11/132 X
- D. 409,519 5/1999 Hammond et al. D11/132

OTHER PUBLICATIONS

The Jerusalem Stone Product Guide, Introducing the Nachum Treatment for Tubza, Samsam, and Taltish Finishes, Kansas City, Missouri 64114, 1998.

1 Claim, 3 Drawing Sheets

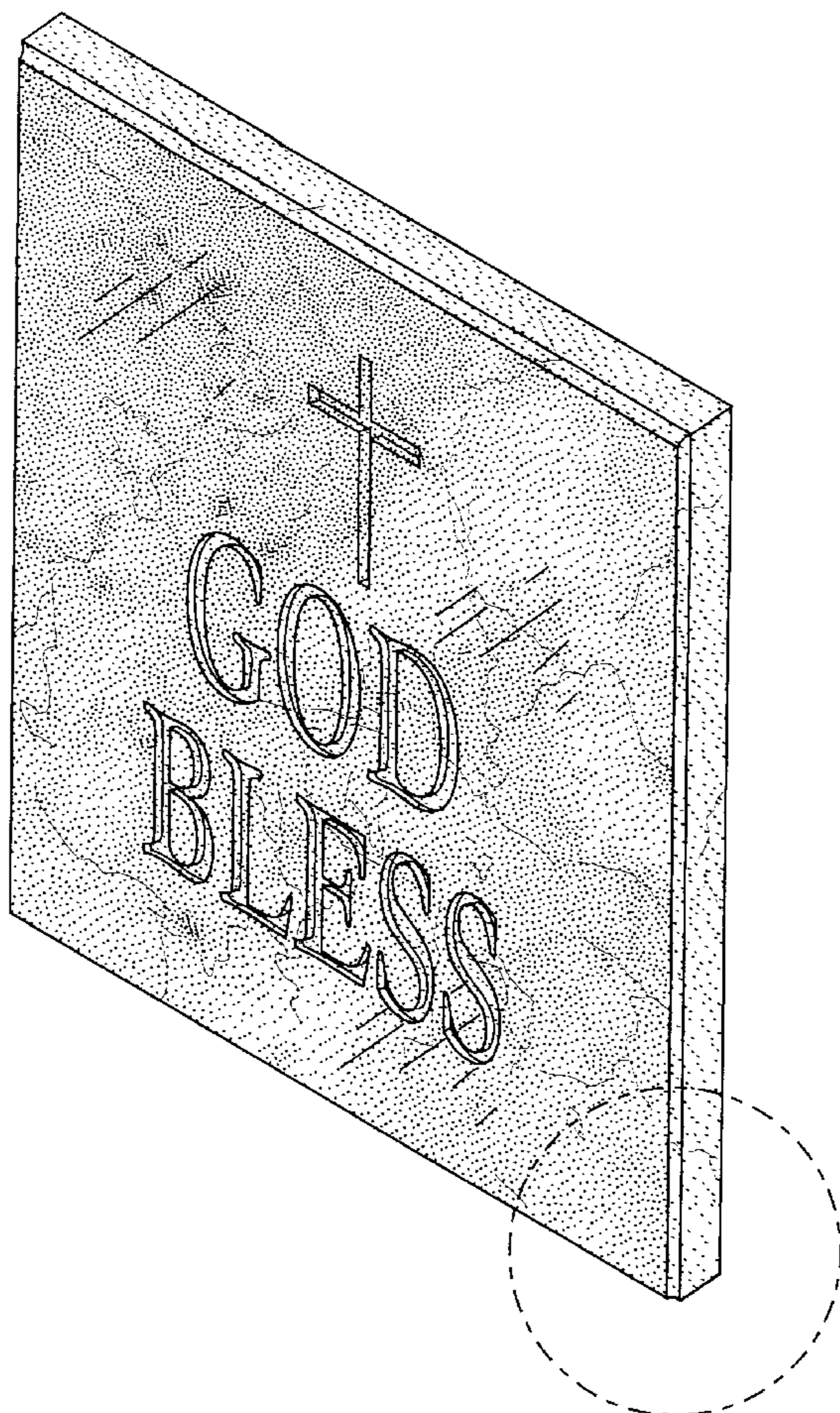

FIG. 1

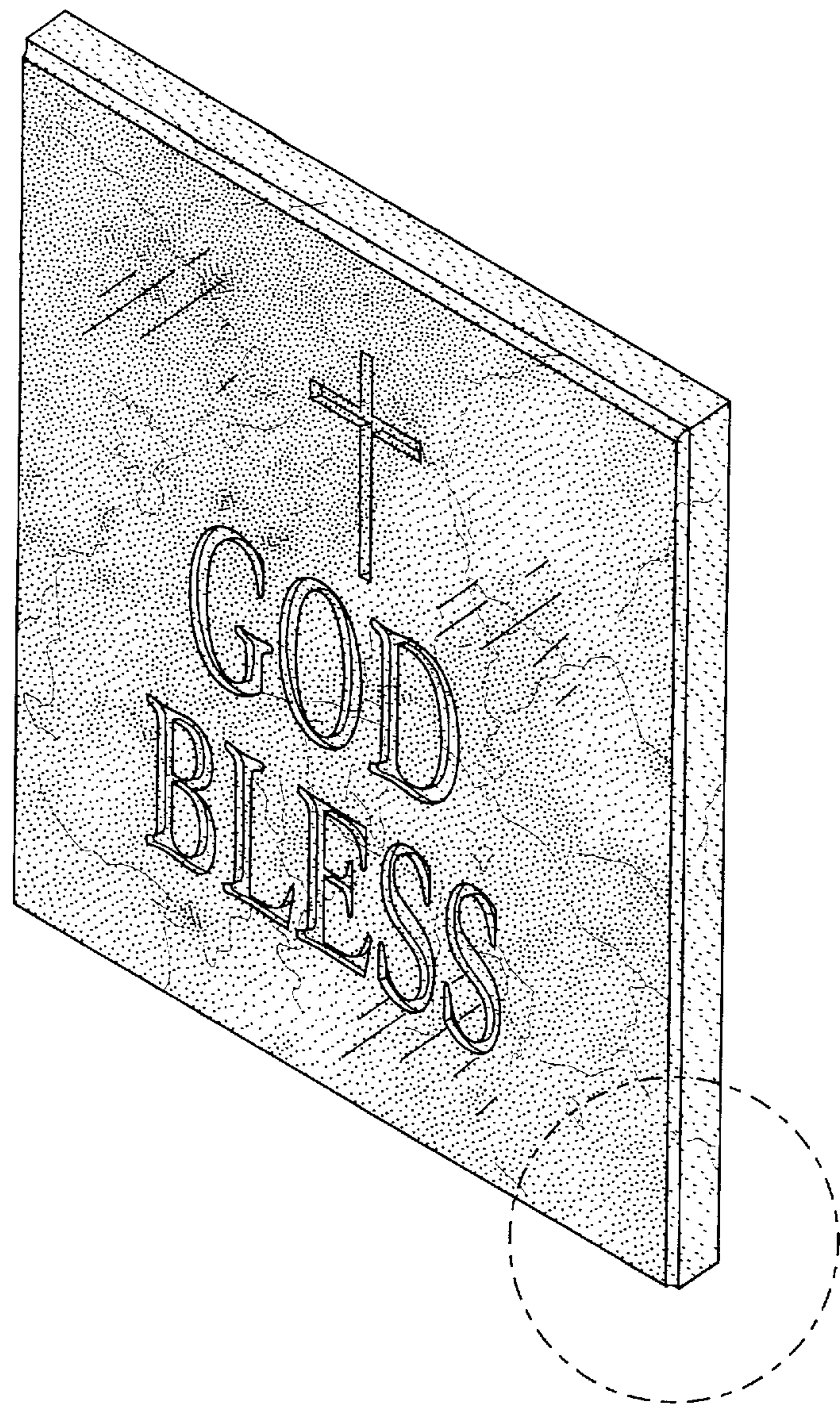

FIG. 2

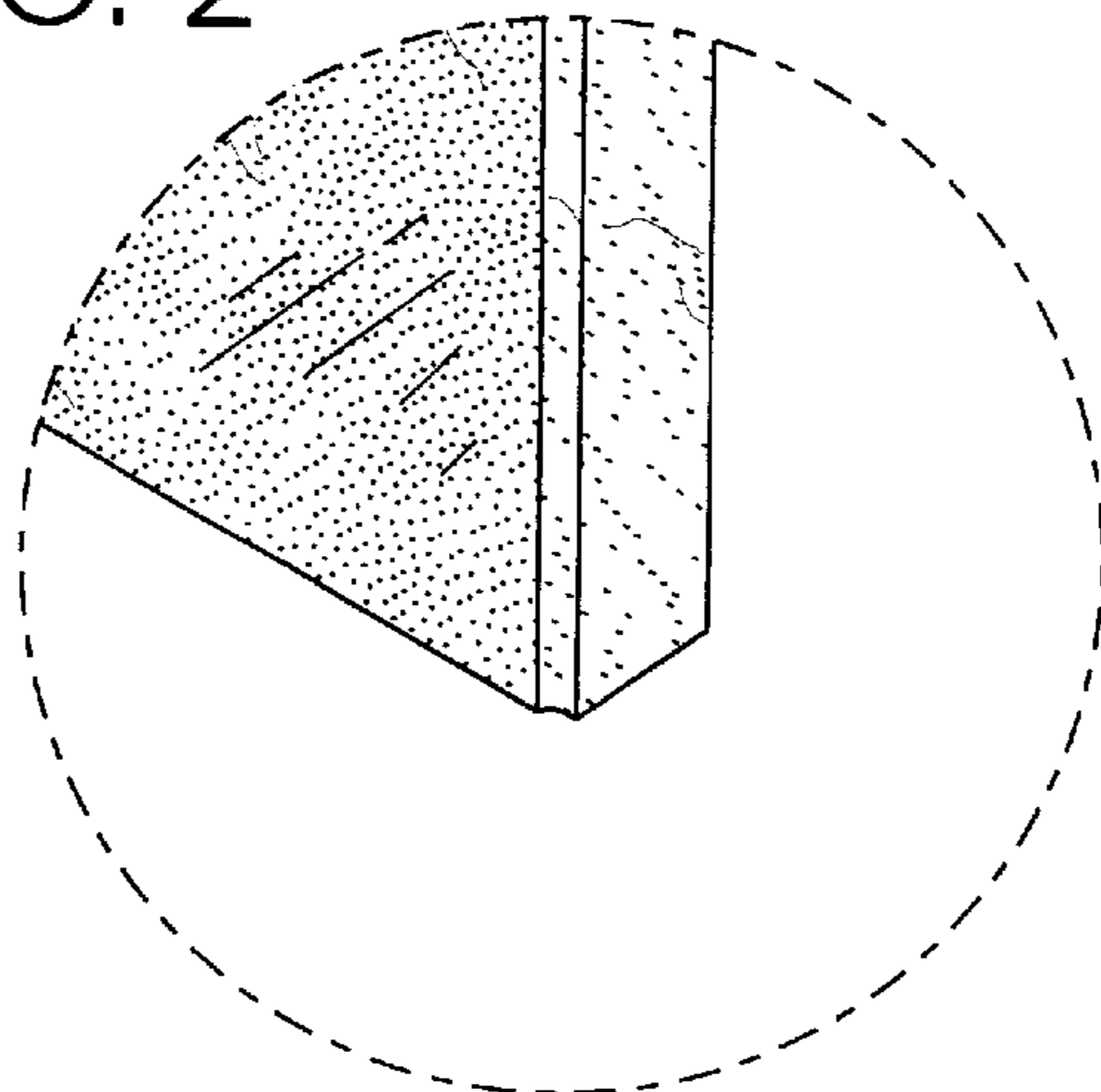

FIG. 3

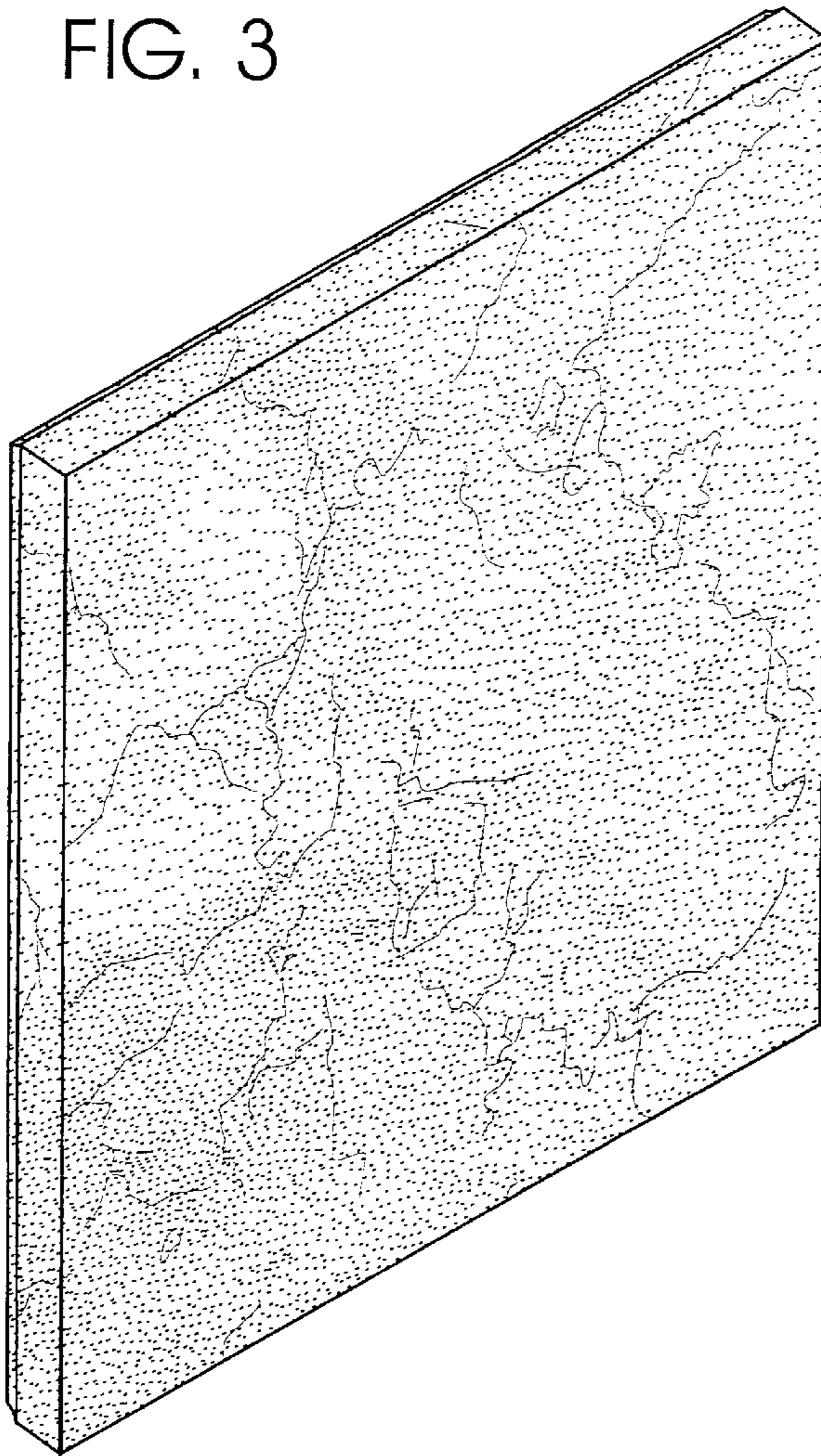

FIG. 4

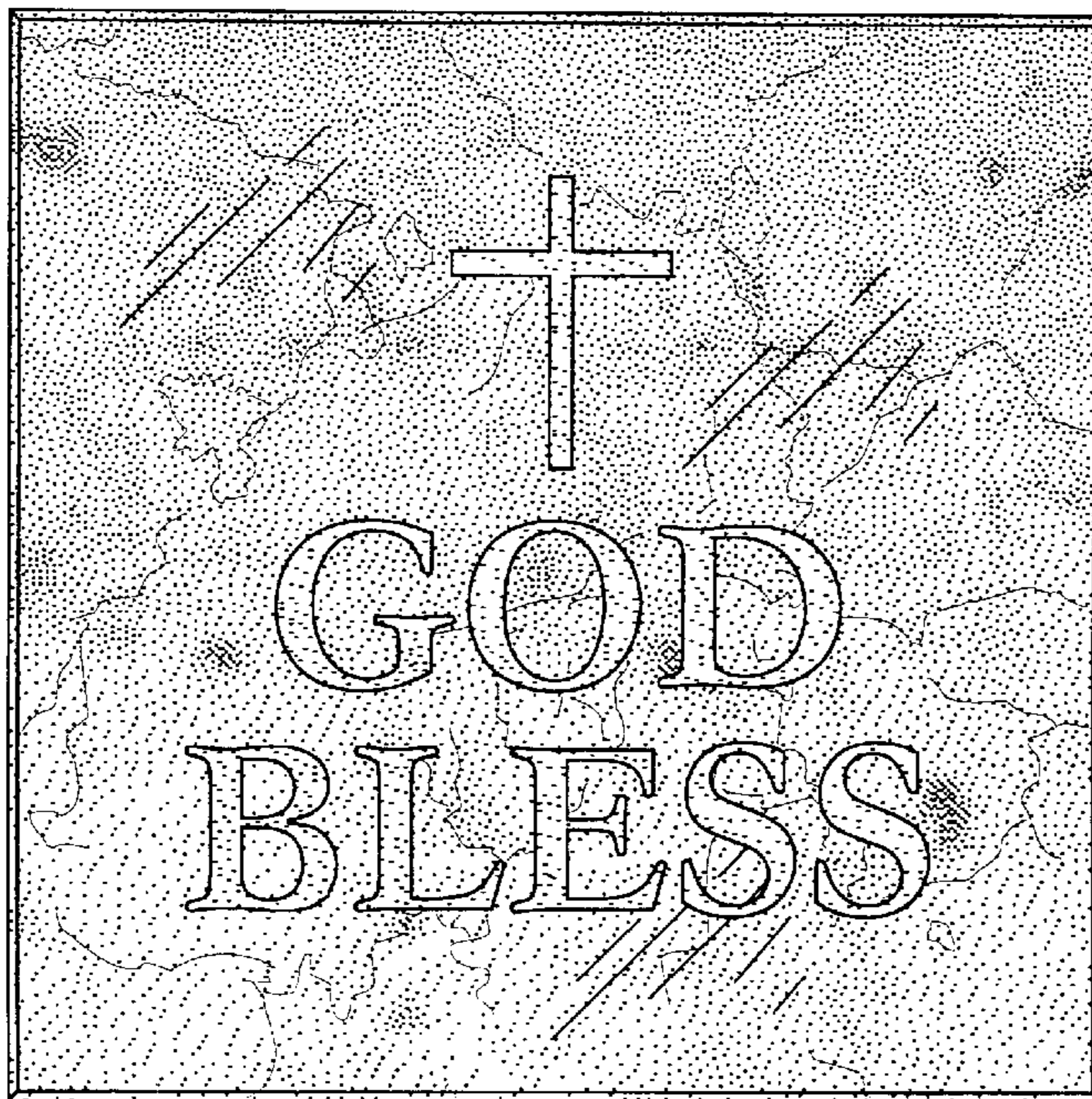

FIG. 5

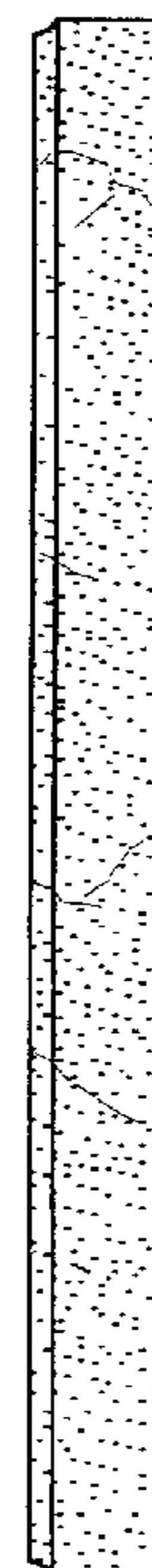

FIG. 6

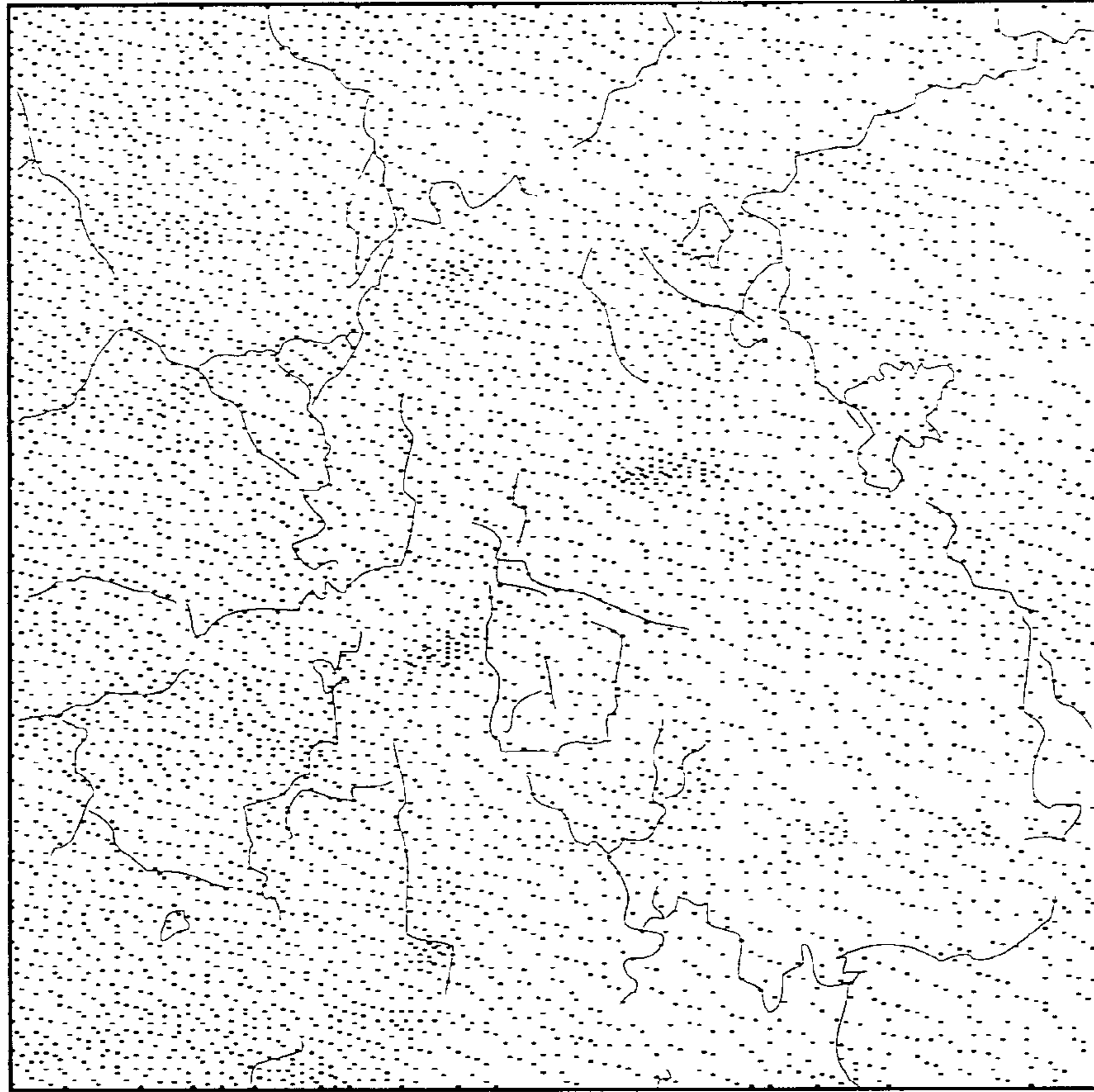

FIG. 7

